



BUREAU
VERITAS

Test Report No: RD2009WDG0430



Certificate # 2951.01

Test Report No.: RD2009WDG0430

Applicant's name : Particle Industries, Inc

Address : 126 Post St, 4th floor, San Francisco, CA 94108 USA

Test item description: Tracker One LTE CAT1/3G/2G

Model/Type reference : ONE523M, ONE524M, ONE523M-NB, ONE524M-NB

Testing laboratory

Name : Bureau Veritas Shenzhen Co., Ltd. Dongguan Branch

Address : No. 96, Guantai Road (Houjie Section), Houjie Town, Dongguan City, Guangdong Province, 523942, People's Republic of China

Test specification

Standard : IEC 62368-1:2014 (Second Edition)
 EN 62368-1:2014 + A11: 2017

Test Result : The samples satisfy to the clauses examined.

Prepared By :

Jetter Yang
Engineer / Safety Department

2020-12-15
Date

Approved By:

Storm Xiong
Senior Engineer / Safety Department

2020-12-15
Date

This report is governed by, and incorporates by reference, CPS Conditions of Service as posted at the date of issuance of this report at <http://www.bureauveritas.com/home/about-us/our-business/cps/about-us/terms-conditions/> and is intended for your exclusive use. Any copying or replication of this report to or for any other person or entity, or use of our name or trademark, is permitted only with our prior written permission. This report sets forth our findings solely with respect to the test samples identified herein. The results set forth in this report are not indicative or representative of the quality or characteristics of the lot from which a test sample was taken or any similar or identical product unless specifically and expressly noted. Our report includes all of the tests requested by you and the results thereof based upon the information that you provided to us. Measurement uncertainty is only provided upon request for accredited tests. You have 60 days from date of issuance of this report to notify us of any material error or omission caused by our negligence or if you require measurement uncertainty; provided, however, that such notice shall be in writing and shall specifically address the issue you wish to raise. A failure to raise such issue within the prescribed time shall constitute your unqualified acceptance of the completeness of this report, the tests conducted and the correctness of the report contents.



TEST REPORT

Report Number: RD2009WDG0430

Date of issue: 2020-12-15

Total number of pages: 70

Testing laboratory: Bureau Veritas Shenzhen Co., Ltd. Dongguan Branch

Test location/Address: No. 96, Guantai Road (Houjie Section), Houjie Town, Dongguan City, Guangdong Province, 523942, People's Republic of China

Applicant's name: Particle Industries, Inc

Address: 126 Post St, 4th floor, San Francisco, CA 94108 USA

Test specification:

Standard: IEC 62368-1: 2014 (Second Edition)
 EN 62368-1: 2014 + A11: 2017

Non-standard test method: N/A

Test Report Form No: IEC/EN 62368-1_DG_V201904

Test Report Form(s) Originator...: BV_DG

Master TRF: Dated 2019-04

Manufacturer: Particle Industries, Inc

Address: 126 Post St, 4th floor, San Francisco, CA 94108 USA

Factory: ABO ELECTRONICS (SHEN ZHEN) CO., LTD

Address: Unit 201-202, Wang Rong Ind Park, 99 Ind Zone, Minzhu, Xihuan road, Shajing, Baoan district, Shenzhen, China

Test item description: Tracker One LTE CAT1/3G/2G

Trade Mark: 

Model/Type reference: ONE523M, ONE524M, ONE523M-NB, ONE524M-NB

Ratings: M8 input: 6-30Vdc, 2A; Type C USB input: 5Vdc, 2A
(3.7V, 2000mAh internal lithium battery for models ONE523M, ONE524M)



Copy of marking plate:

The below marking is only for representative. The official marking plate of all models may be different from format of label, model number for trading purpose.

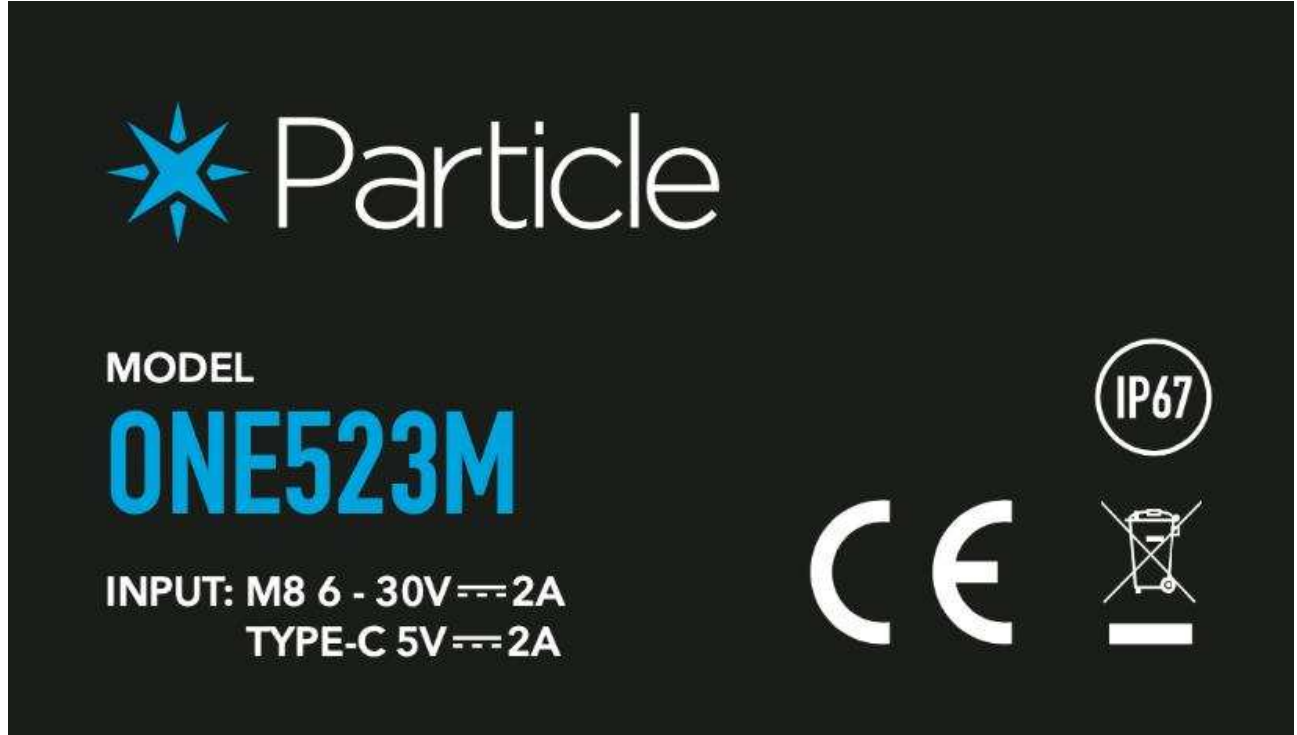

WEEE logo(crossed-out wheeled bin symbol with solid bar): at least 7 mm in height

Note 1: The instruction sheet and marking should be translated to the language where the product will be sold.
Note 2: To comply with RED Directive 2014/53/EU, the manufacturer has the responsibility to put manufacturer name / trade mark and their address, batch number on the equipment. And the importer also has the responsibility to put their name / trade mark and address on the equipment before place the equipment on the market.



TEST ITEM PARTICULARS:	
Classification of use by	<input checked="" type="checkbox"/> Ordinary person <input checked="" type="checkbox"/> Instructed person <input checked="" type="checkbox"/> Skilled person <input type="checkbox"/> Children likely to be present
Supply Connection.....	<input type="checkbox"/> AC Mains <input type="checkbox"/> DC Mains <input checked="" type="checkbox"/> External Circuit - not Mains connected - <input checked="" type="checkbox"/> ES1 <input type="checkbox"/> ES2 <input type="checkbox"/> ES3
Supply % Tolerance	<input type="checkbox"/> +10%/-10% <input type="checkbox"/> +20%/-15% <input type="checkbox"/> +___%/ -___% <input checked="" type="checkbox"/> None (Manufacturer declares)
Supply Connection – Type	<input type="checkbox"/> pluggable equipment type A - <input type="checkbox"/> non-detachable supply cord <input type="checkbox"/> appliance coupler <input type="checkbox"/> direct plug-in <input type="checkbox"/> mating connector <input type="checkbox"/> pluggable equipment type B - <input type="checkbox"/> non-detachable supply cord <input type="checkbox"/> appliance coupler <input type="checkbox"/> permanent connection <input type="checkbox"/> mating connector <input checked="" type="checkbox"/> other: Supplied by internal lithium battery or external DC source
Considered current rating of protective device as part of building or equipment installation.....	N/A Installation location: <input type="checkbox"/> building; <input type="checkbox"/> equipment
Equipment mobility	<input checked="" type="checkbox"/> movable <input type="checkbox"/> hand-held <input checked="" type="checkbox"/> transportable <input type="checkbox"/> stationary <input type="checkbox"/> for building-in <input type="checkbox"/> direct plug-in <input type="checkbox"/> rack-mounting <input type="checkbox"/> wall-mounted
Over voltage category (OVC)	<input type="checkbox"/> OVC I <input type="checkbox"/> OVC II <input type="checkbox"/> OVC III <input type="checkbox"/> OVC IV <input checked="" type="checkbox"/> other: Supplied by internal lithium battery or external DC source
Class of equipment	<input type="checkbox"/> Class I <input type="checkbox"/> Class II <input checked="" type="checkbox"/> Class III
Access location	<input type="checkbox"/> restricted access location <input checked="" type="checkbox"/> N/A
Pollution degree (PD)	<input type="checkbox"/> PD 1 <input checked="" type="checkbox"/> PD 2 <input type="checkbox"/> PD 3
Manufacturer's specified maximum operating ambient:	45°C
IP protection class	<input type="checkbox"/> IPX0 <input checked="" type="checkbox"/> IP_67__
Power Systems	<input type="checkbox"/> TN <input type="checkbox"/> TT <input type="checkbox"/> IT - 230 V _{L-L}
Altitude during operation (m)	<input checked="" type="checkbox"/> 2000 m or less <input type="checkbox"/> 5000 m or less
Altitude of test laboratory (m)	<input checked="" type="checkbox"/> 2000 m or less <input type="checkbox"/> 5000 m or less
Mass of equipment (kg)	<input checked="" type="checkbox"/> Approximate 0.28kg excludes input cable



POSSIBLE TEST CASE VERDICTS:	
- test case does not apply to the test object	N/A
- test object does meet the requirement	P (Pass)
- test object does not meet the requirement	F (Fail)
TESTING:	
Date of receipt of test item.....	October 09, 2020
Date (s) of performance of tests.....	October 09, 2020 to October 29, 2020

GENERAL REMARKS:

"(See Enclosure #)" refers to additional information appended to the report.
 "(See appended table)" refers to a table appended to the report.

Throughout this report a comma / point is used as the decimal separator.

GENERAL PRODUCT INFORMATION:

Product Description

1. The equipment is a "Tracker One LTE CAT1/3G/2G" which is supplied by internal lithium battery or external DC source comply with requirements of PS2.
2. Physical Size: approx. 146mm x 88mm x 33mm.
3. The EUT's enclosures are secured together by screw.

Model Differences

1. The equipment has two kinds of sample with Version 1.0 and Version 1.1, the sample with Version 1.1 is to only add a GPIO isolation circuit (show below) base on the sample with Version 1.0 for trading purpose.

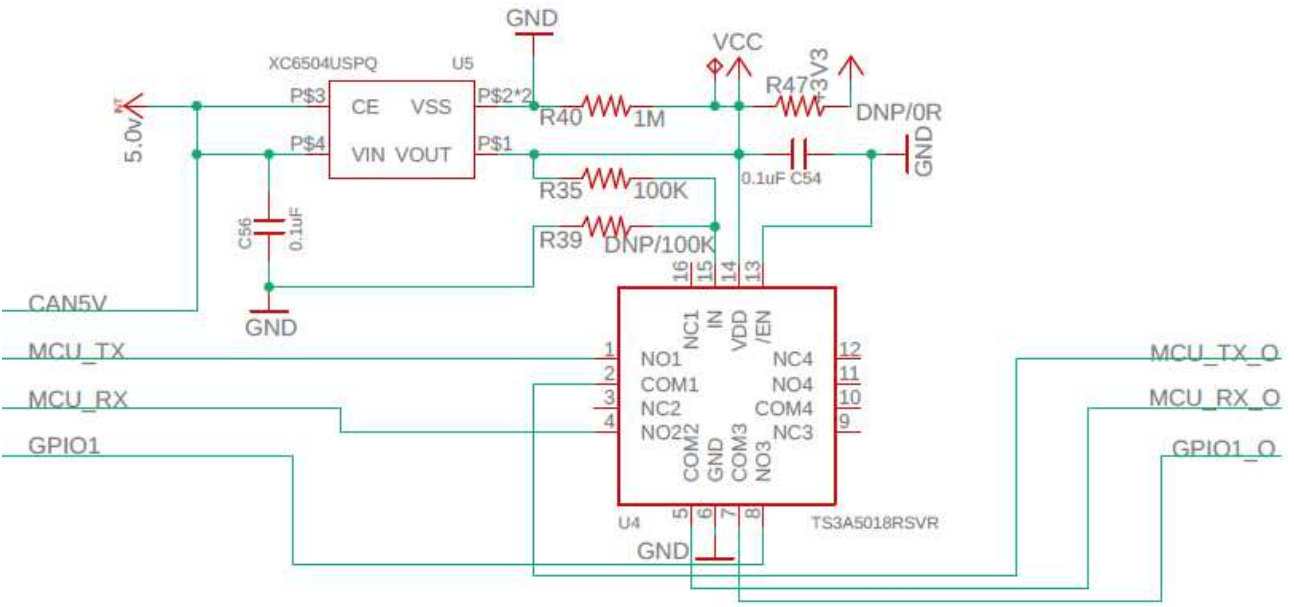



2. The equipment with models ONE523M, ONE524M, ONE523M-NB, ONE524M-NB are identical to each other except model name and with or without internal battery, the differences between are listed in following table:

Model name	Whether has internal battery?
ONE523M, ONE524M	Yes
ONE523M-NB, ONE524M-NB	No

Additional application considerations – (Considerations used to test a component or sub-assembly)

- All tests were measured under the worst case and the load conditions used during testing are:
 - Supplied by external DC source, the EUT was working normally with max. power, internal fully discharged battery was charging;
 - Supplied by internal fully charged battery, the EUT was working normally with max. power.
- If not separately specified, all tests were performed on the model ONE523M with Version 1.1.
- The equipment comply with requirement of IP67 which had been evaluated by Guangdong Sushi Guangbo Testing Technology Co., Ltd with test report GDGT-H/R-2020-0470-6 dated on September 16, 2020 according to standard of IEC 60529: 2013.



ENERGY SOURCE IDENTIFICATION AND CLASSIFICATION TABLE:	
<p>(Note 1: Identify the following six (6) energy source forms based on the origin of the energy.) (Note 2: The identified classification e.g., ES2, TS1, should be with respect to its ability to cause pain or injury on the body or its ability to ignite a combustible material. Any energy source can be declared Class 3 as a worse case classification e.g. PS3, ES3.)</p>	
<p>Electrically-caused injury (Clause 5): (Note: Identify type of source, list sub-assembly or circuit designation and corresponding energy source classification) Example: +5 V dc input ES1</p>	
Source of electrical energy	Corresponding classification (ES)
All parts within equipment (5Vdc, or 6-30Vdc input)	ES1
<p>Electrically-caused fire (Clause 6): (Note: List sub-assembly or circuit designation and corresponding energy source classification) Example: Battery pack (maximum 85 watts): PS2</p>	
Source of power or PIS	Corresponding classification (PS)
All parts within equipment	PS2 (manufacturer declares)
<p>Injury caused by hazardous substances (Clause 7) (Note: Specify hazardous chemicals, whether produces ozone or other chemical construction not addressed as part of the component evaluation.) Example: Liquid in filled component Glycol</p>	
Source of hazardous substances	Corresponding chemical
Battery (in the EUT)	Electrolyte
<p>Mechanically-caused injury (Clause 8) (Note: List moving part(s), fan, special installations, etc. & corresponding MS classification based on Table 35.) Example: Wall mount unit MS2</p>	
Source of kinetic/mechanical energy	Corresponding classification (MS)
Shape edges and corner of product	MS1
Equipment mass- Approximate 0.28kg<7Kg.	MS1
<p>Thermal burn injury (Clause 9) (Note: Identify the surface or support, and corresponding energy source classification based on type of part, location, operating temperature and contact time in Table 38.) Example: Hand-held scanner – thermoplastic enclosure TS1</p>	
Source of thermal energy	Corresponding classification (TS)
Enclosure surface	TS1
<p>Radiation (Clause 10) (Note: List the types of radiation present in the product and the corresponding energy source classification.) Example: DVD – Class 1 Laser Product RS1</p>	
Type of radiation	Corresponding classification (RS)
LED used for indicating light	RS1



ENERGY SOURCE DIAGRAM

Indicate which energy sources are included in the energy source diagram. Insert diagram below

ES **PS** **MS** **TS** **RS**

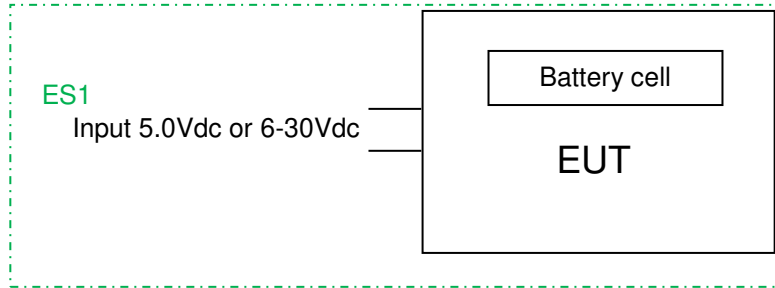

- ES1: All parts within equipment;
- PS2: All parts within equipment;
- MS1: Accessible surface of equipment; mass of equipment
- TS1: Accessible surface of equipment;
- RS1: LED used for indicating light.



OVERVIEW OF EMPLOYED SAFEGUARDS				
Clause	Possible Hazard			
5.1	Electrically-caused injury			
Body Part (e.g. Ordinary)	Energy Source (ES3: Primary Filter circuit)	Safeguards		
		Basic	Supplementary	Reinforced
Ordinary	ES1: All parts within equipment	N/A	N/A	N/A
6.1	Electrically-caused fire			
Material part (e.g. mouse enclosure)	Energy Source (PS2: 100 Watt circuit)	Safeguards		
		Basic	Supplementary	Reinforced
All combustible materials around all circuit within equipment	PS2: All parts within equipment	No ignition and attainable high temperature value	Control fire spread, V-1 or better PCB and V-0 fire enclosure provided	N/A
7.1	Injury caused by hazardous substances			
Body Part (e.g., skilled)	Energy Source (hazardous material)	Safeguards		
		Basic	Supplementary	Reinforced
Ordinary	Chemical electrolyte	N/A	The metallic enclosure of battery used as container	N/A
8.1	Mechanically-caused injury			
Body Part (e.g. Ordinary)	Energy Source (MS3:High Pressure Lamp)	Safeguards		
		Basic	Supplementary	Reinforced (Enclosure)
Ordinary	MS1	N/A	N/A	N/A
9.1	Thermal Burn			
Body Part (e.g., Ordinary)	Energy Source (TS2)	Safeguards		
		Basic	Supplementary	Reinforced
Ordinary	TS1: Accessible surface	N/A	N/A	N/A
10.1	Radiation			
Body Part (e.g., Ordinary)	Energy Source (Output from audio port)	Safeguards		
		Basic	Supplementary	Reinforced
Ordinary	RS1 (LED used for indicating light)	N/A	N/A	N/A
Supplementary Information:				
(1) See attached energy source diagram for additional details.				
(2) "N" – Normal Condition; "A" – Abnormal Condition; "S" Single Fault				



IEC/EN 62368-1

Clause	Requirement + Test	Result - Remark	Verdict
4	GENERAL REQUIREMENTS		P
4.1.1	Acceptance of materials, components and subassemblies	See appended table 4.1.2	P
4.1.2	Use of components	Components which are certified to IEC and/or national standards are used correctly within their ratings. Components not covered by IEC standards are tested under the conditions present in the equipment.	P
4.1.3	Equipment design and construction	No accessible part which could cause injury	P
4.1.15	Markings and instructions	(See Annex F)	P
4.4.4	Safeguard robustness	See below	P
4.4.4.2	Steady force tests	(See Annex T.4)	P
4.4.4.3	Drop tests	(See Annex T.7)	P
4.4.4.4	Impact tests	The EUT is transportable equipment	N/A
4.4.4.5	Internal accessible safeguard enclosure and barrier tests	No such part	N/A
4.4.4.6	Glass Impact tests	No such part	N/A
4.4.4.7	Thermoplastic material tests.....	(See Annex T.8)	P
4.4.4.8	Air comprising a safeguard	Only ES1 exist, no safeguards required	N/A
4.4.4.9	Accessibility and safeguard effectiveness	The safeguard is remained effective	P
4.5	Explosion	No explosion occurs during normal/abnormal operation and single fault conditions, See appended table B.2.6 and B.4	P
4.6	Fixing of conductors	See below	N/A
4.6.1	Fix conductors not to defeat a safeguard	Only ES1 exist, no safeguards required	N/A
4.6.2	10 N force test applied to	Only ES1 exist, no safeguards required	N/A
4.7	Equipment for direct insertion into mains socket - outlets	Not such equipment	N/A
4.7.2	Mains plug part complies with the relevant standard.....	Not such equipment	N/A



IEC/EN 62368-1			
Clause	Requirement + Test	Result - Remark	Verdict
4.7.3	Torque (Nm)	Not such equipment	N/A
4.8	Products containing coin/button cell batteries	See below	N/A
4.8.2	Instructional safeguard	No such battery	N/A
4.8.3	Battery Compartment Construction	No such battery	N/A
	Means to reduce the possibility of children removing the battery		—
4.8.4	Battery Compartment Mechanical Tests	(See appended table 4.8.4)	N/A
4.8.5	Battery Accessibility		N/A
4.9	Likelihood of fire or shock due to entry of conductive object	(See Annex P)	P

5	ELECTRICALLY-CAUSED INJURY		P
5.2.1	Electrical energy source classifications	All parts complied with ES1	P
5.2.2	ES1, ES2 and ES3 limits	All parts complied with ES1	P
5.2.2.2	Steady-state voltage and current	(See appended table 5.2)	P
5.2.2.3	Capacitance limits	No such capacitance	N/A
5.2.2.4	Single pulse limits	No such pulse	N/A
5.2.2.5	Limits for repetitive pulses	No such pulse	N/A
5.2.2.6	Ringling signals	No such ringing signal	N/A
5.2.2.7	Audio signals	No such audio signal	N/A
5.3	Protection against electrical energy sources	See below	N/A
5.3.1	General Requirements for accessible parts to ordinary, instructed and skilled persons	Only ES1 parts are existed inside the EUT	N/A
5.3.2.1	Accessibility to electrical energy sources and safeguards	Only ES1 parts are existed inside the EUT	N/A
5.3.2.2	Contact requirements	Only ES1 parts are existed inside the EUT	N/A
	a) Test with test probe from Annex V	Only ES1 parts are existed inside the EUT	N/A
	b) Electric strength test potential (V)	Only ES1 parts are existed inside the EUT	N/A
	c) Air gap (mm)	Only ES1 parts are existed inside the EUT	N/A
5.3.2.4	Terminals for connecting stripped wire	No such part	N/A
5.4	Insulation materials and requirements		N/A



IEC/EN 62368-1			
Clause	Requirement + Test	Result - Remark	Verdict
5.4.1.2	Properties of insulating material	Class III equipment, only ES1 parts are existed inside the EUT	N/A
5.4.1.3	Humidity conditioning.....:	No hygroscopic material used	N/A
5.4.1.4	Maximum operating temperature for insulating materials	Only ES1 parts are existed inside the EUT, no such part	N/A
5.4.1.5	Pollution degree	Pollution degree 2 is considered	—
5.4.1.5.2	Test for pollution degree 1 environment and for an insulating compound	Pollution degree 2 is considered	N/A
5.4.1.5.3	Thermal cycling	No such device	N/A
5.4.1.6	Insulation in transformers with varying dimensions	No such part	N/A
5.4.1.7	Insulation in circuits generating starting pulses	No such pules occurred	N/A
5.4.1.8	Determination of working voltage	Class III equipment, only ES1 parts are existed inside the EUT	N/A
5.4.1.9	Insulating surfaces	Only ES1 parts are existed inside the EUT, no such part	N/A
5.4.1.10	Thermoplastic parts on which conductive metallic parts are directly mounted	No such part	N/A
5.4.1.10.2	Vicat softening temperature	No such part	N/A
5.4.1.10.3	Ball pressure	No such part	N/A
5.4.2	Clearances	Class III equipment and all electrical circuits of EUT are ES1, only the functional insulation inside the EUT	N/A
5.4.2.2	Determining clearance using peak working voltage	Class III equipment and all electrical circuits of EUT are ES1, only the functional insulation inside the EUT	N/A
5.4.2.3	Determining clearance using required withstand voltage	Class III equipment and all electrical circuits of EUT are ES1, and there is no critical insulation.	N/A
	a) a.c. mains transient voltage	The equipment does not intend to connected to a.c. mains	—
	b) d.c. mains transient voltage	The equipment does not intend to connected to d.c. mains	—
	c) external circuit transient voltage	No such external circuit	—
	d) transient voltage determined by measurement..... :	Only ES1 parts are existed inside the EUT	—
5.4.2.4	Determining the adequacy of a clearance using an electric strength test	Not used	N/A



IEC/EN 62368-1			
Clause	Requirement + Test	Result - Remark	Verdict
5.4.2.5	Multiplication factors for clearances and test voltages	Not used	N/A
5.4.3	Creepage distances	Class III equipment and all electrical circuits of EUT are ES1, only the functional insulation inside the EUT	N/A
5.4.3.1	General	Class III equipment and all electrical circuits of EUT are ES1, only the functional insulation inside the EUT	N/A
5.4.3.3	Material Group	Group IIIb considered	—
5.4.4	Solid insulation	Class III equipment and all electrical circuits of EUT are ES1, and there is no critical insulation.	N/A
5.4.4.2	Minimum distance through insulation	No such part	N/A
5.4.4.3	Insulation compound forming solid insulation	No such part	N/A
5.4.4.4	Solid insulation in semiconductor devices	No such part	N/A
5.4.4.5	Cemented joints	No such part	N/A
5.4.4.6	Thin sheet material	No such part	N/A
5.4.4.6.1	General requirements	No such part	N/A
5.4.4.6.2	Separable thin sheet material	No such part	N/A
	Number of layers (pcs)	No such part	N/A
5.4.4.6.3	Non-separable thin sheet material	No such part	N/A
5.4.4.6.4	Standard test procedure for non-separable thin sheet material	No such part	N/A
5.4.4.6.5	Mandrel test	No such part	N/A
5.4.4.7	Solid insulation in wound components	No such part	N/A
5.4.4.9	Solid insulation at frequencies >30 kHz.....	No such part	N/A
5.4.5	Antenna terminal insulation	No such part	N/A
5.4.5.1	General	No such part	N/A
5.4.5.2	Voltage surge test	No such part	N/A
	Insulation resistance (MΩ)	--	—
5.4.6	Insulation of internal wire as part of supplementary safeguard	Class III equipment and all electrical circuits of EUT are ES1, only the functional insulation inside the EUT	N/A
5.4.7	Tests for semiconductor components and for cemented joints	No semiconductor components and for cemented joints	N/A



IEC/EN 62368-1			
Clause	Requirement + Test	Result - Remark	Verdict
5.4.8	Humidity conditioning	Class III equipment and all electrical circuits of EUT are ES1, only the functional insulation inside the EUT	N/A
	Relative humidity (%)	--	—
	Temperature (°C)	--	—
	Duration (h)	--	—
5.4.9	Electric strength test	Class III equipment and all electrical circuits of EUT are ES1, only the functional insulation inside the EUT	N/A
5.4.9.1	Test procedure for a solid insulation type test	Class III equipment and all electrical circuits of EUT are ES1, only the functional insulation inside the EUT	N/A
5.4.9.2	Test procedure for routine tests	Class III equipment and all electrical circuits of EUT are ES1, only the functional insulation inside the EUT	N/A
5.4.10	Protection against transient voltages between external circuit	The EUT does not intend to be connected directly such external circuits	N/A
5.4.10.1	Parts and circuits separated from external circuits	The EUT does not intend to be connected directly such external circuits	N/A
5.4.10.2	Test methods		N/A
5.4.10.2.1	General		N/A
5.4.10.2.2	Impulse test.....	The EUT does not intend to be connected directly such external circuits	N/A
5.4.10.2.3	Steady-state test.....	The EUT does not intend to be connected directly such external circuits	N/A
5.4.11	Insulation between external circuits and earthed circuitry.....	The EUT does not intend to be connected directly such external circuits	N/A
5.4.11.1	Exceptions to separation between external circuits and earth	The EUT does not intend to be connected directly such external circuits	N/A
5.4.11.2	Requirements	No SPD used	N/A
	Rated operating voltage U_{op} (V)	--	—



IEC/EN 62368-1

Clause	Requirement + Test	Result - Remark	Verdict
	Nominal voltage U_{peak} (V)	--	—
	Max increase due to variation U_{sp}	--	—
	Max increase due to ageing ΔU_{sa}	--	—
	$U_{op} = U_{peak} + \Delta U_{sp} + \Delta U_{sa}$	--	—
5.5	Components as safeguards		N/A
5.5.1	General	See below	N/A
5.5.2	Capacitors and RC units	No such component	N/A
5.5.2.1	General requirement	No such component	N/A
5.5.2.2	Safeguards against capacitor discharge after disconnection of a connector	No such component	N/A
5.5.3	Transformers	No such component	N/A
5.5.4	Optocouplers	No such component	N/A
5.5.5	Relays	No such component	N/A
5.5.6	Resistors	No such component	N/A
5.5.7	SPD's	No such component	N/A
5.5.7.1	Use of an SPD connected to reliable earthing	No such component	N/A
5.5.7.2	Use of an SPD between mains and protective earth	No such component	N/A
5.5.8	Insulation between the mains and external circuit consisting of a coaxial cable	No such construction	N/A
5.6	Protective conductor		N/A
5.6.2	Requirement for protective conductors	No such device	N/A
5.6.2.1	General requirements	No such device	N/A
5.6.2.2	Colour of insulation	No such device	N/A
5.6.3	Requirement for protective earthing conductors	No such device	N/A
	Protective earthing conductor size (mm ²)	No such device	—
5.6.4	Requirement for protective bonding conductors	No such device	N/A
5.6.4.1	Protective bonding conductors	No such device	N/A
	Protective bonding conductor size (mm ²).	No such part	—
	Protective current rating (A)	No such part	—
5.6.4.3	Current limiting and overcurrent protective devices	No such device	N/A
5.6.5	Terminals for protective conductors	No such device	N/A
5.6.5.1	Requirement	No such device	N/A



IEC/EN 62368-1			
Clause	Requirement + Test	Result - Remark	Verdict
	Conductor size (mm ²), nominal thread diameter (mm)..... :	No such device	N/A
5.6.5.2	Corrosion	No such device	N/A
5.6.6	Resistance of the protective system	No such device	N/A
5.6.6.1	Requirements	No such device	N/A
5.6.6.2	Test Method Resistance (Ω)..... :	No such device	N/A
5.6.7	Reliable earthing	No such device	N/A
5.7	Prospective touch voltage, touch current and protective conductor current		N/A
5.7.2	Measuring devices and networks	Supplied by ES1 electrical energy source	N/A
5.7.2.1	Measurement of touch current..... :	Supplied by ES1 electrical energy source	N/A
5.7.2.2	Measurement of prospective touch voltage	Supplied by ES1 electrical energy source	N/A
5.7.3	Equipment set-up, supply connections and earth connections	Supplied by ES1 electrical energy source	N/A
	System of interconnected equipment (separate connections/single connection)..... :		—
	Multiple connections to mains (one connection at a time/simultaneous connections)..... :		—
5.7.4	Earthed conductive accessible parts..... :	No earthed conductive part	N/A
5.7.5	Protective conductor current	No protective conductor	N/A
	Supply Voltage (V)..... :		—
	Measured current (mA)..... :		—
	Instructional Safeguard..... :	No protective conductor	N/A
5.7.6	Prospective touch voltage and touch current due to external circuits	See below	N/A
5.7.6.1	Touch current from coaxial cables	The equipment does not intend to be connected to coaxial cable	N/A
5.7.6.2	Prospective touch voltage and touch current from external circuits	The equipment does not intend to be connected to such external circuit	N/A
5.7.7	Summation of touch currents from external circuits	The equipment does not intend to be connected to such external circuit	N/A
	a) Equipment with earthed external circuits Measured current (mA)..... :	The equipment does not intend to be connected to such external circuit	N/A



IEC/EN 62368-1

Clause	Requirement + Test	Result - Remark	Verdict
	b) Equipment whose external circuits are not referenced to earth. Measured current (mA) :	The equipment does not intend to be connected to such external circuit	N/A

6	ELECTRICALLY- CAUSED FIRE		P
6.2	Classification of power sources (PS) and potential ignition sources (PIS)		P
6.2.2	Power source circuit classifications	PS2 for all parts within equipment	P
6.2.2.1	General		P
6.2.2.2	Power measurement for worst-case load fault..... :	(See appended table 6.2.2)	P
6.2.2.3	Power measurement for worst-case power source fault :	(See appended table 6.2.2)	P
6.2.2.4	PS1 :	(See appended table 6.2.2)	P
6.2.2.5	PS2 :	(See appended table 6.2.2)	P
6.2.2.6	PS3 :		N/A
6.2.3	Classification of potential ignition sources		P
6.2.3.1	Arcing PIS :	No such part	N/A
6.2.3.2	Resistive PIS :	(See appended table 6.2.3.2)	P
6.3	Safeguards against fire under normal operating and abnormal operating conditions		P
6.3.1 (a)	No ignition and attainable temperature value less than 90 % defined by ISO 871 or less than 300 °C for unknown materials..... :	No ignition and attainable such temperature value	P
6.3.1 (b)	Combustible materials outside fire enclosure	No such materials used outside fire enclosure	N/A
6.4	Safeguards against fire under single fault conditions		P
6.4.1	Safeguard Method	Control fire spread considered	P
6.4.2	Reduction of the likelihood of ignition under single fault conditions in PS1 circuits	Control fire spread considered	N/A
6.4.3	Reduction of the likelihood of ignition under single fault conditions in PS2 and PS3 circuits	Control fire spread considered	N/A
6.4.3.1	General		N/A
6.4.3.2	Supplementary Safeguards		N/A
	Special conditions if conductors on printed boards are opened or peeled		N/A
6.4.3.3	Single Fault Conditions :	Control fire spread considered	N/A
	Special conditions for temperature limited by fuse		N/A
6.4.4	Control of fire spread in PS1 circuits		P



IEC/EN 62368-1			
Clause	Requirement + Test	Result - Remark	Verdict
6.4.5	Control of fire spread in PS2 circuits	See below	P
6.4.5.2	Supplementary safeguards	Rated V-1 or better PCB material used; V-0 fire enclosure used	P
6.4.6	Control of fire spread in PS3 circuit	No such part	N/A
6.4.7	Separation of combustible materials from a PIS		N/A
6.4.7.1	General		N/A
6.4.7.2	Separation by distance		N/A
6.4.7.3	Separation by a fire barrier		N/A
6.4.8	Fire enclosures and fire barriers	See below	P
6.4.8.1	Fire enclosure and fire barrier material properties	Impede the spread of fire by fire enclosure	P
6.4.8.2.1	Requirements for a fire barrier	No such fire barrier	N/A
6.4.8.2.2	Requirements for a fire enclosure	V-0 plastic enclose used to contains the battery	P
6.4.8.3	Constructional requirements for a fire enclosure and a fire barrier	See below	P
6.4.8.3.1	Fire enclosure and fire barrier openings	See below	P
6.4.8.3.2	Fire barrier dimensions	No fire barrier	N/A
6.4.8.3.3	Top Openings in Fire Enclosure: dimensions (mm)	No opening	P
	Needle Flame test		N/A
6.4.8.3.4	Bottom Openings in Fire Enclosure, condition met a), b) and/or c) dimensions (mm)	No opening	P
	Flammability tests for the bottom of a fire enclosure		N/A
6.4.8.3.5	Integrity of the fire enclosure, condition met: a), b) or c).....	No such part	N/A
6.4.8.4	Separation of PIS from fire enclosure and fire barrier distance (mm) or flammability rating	V-0 plastic enclose used	P
6.5	Internal and external wiring		P
6.5.1	Requirements	Approved lead wire used	P
6.5.2	Cross-sectional area (mm ²)	see appended table 4.1.2	—
6.5.3	Requirements for interconnection to building wiring.....	No such connection	N/A
6.6	Safeguards against fire due to connection to additional equipment	See below	P



IEC/EN 62368-1

Clause	Requirement + Test	Result - Remark	Verdict
	External port limited to PS2 or complies with Clause Q.1	The external ports are limited to PS1	P

7	INJURY CAUSED BY HAZARDOUS SUBSTANCES		P
7.2	Reduction of exposure to hazardous substances	No hazardous substances exposure.	P
7.3	Ozone exposure	No ozone production within the equipment.	N/A
7.4	Use of personal safeguards (PPE)	No such consideration.	N/A
	Personal safeguards and instructions	See above.	—
7.5	Use of instructional safeguards and instructions	No chemical-caused injuries, the instruction safeguard was not required.	N/A
	Instructional safeguard (ISO 7010).....	(See Annex F)	—
7.6	Batteries.....	(See Annex M)	P

8	MECHANICALLY-CAUSED INJURY		P
8.1	General		P
8.2	Mechanical energy source classifications	MS1 category of mechanical energy source	P
8.3	Safeguards against mechanical energy sources	MS1 category of mechanical energy source	P
8.4	Safeguards against parts with sharp edges and corners	MS1 category of mechanical energy source	P
8.4.1	Safeguards	MS1 category of mechanical energy source	N/A
8.5	Safeguards against moving parts	No such moving part	N/A
8.5.1	MS2 or MS3 part required to be accessible for the function of the equipment	No such moving part	N/A
8.5.2	Instructional Safeguard	No such moving part	—
8.5.4	Special categories of equipment comprising moving parts	No such moving part	N/A
8.5.4.1	Large data storage equipment	Not such equipment	N/A
8.5.4.2	Equipment having electromechanical device for destruction of media	Not such equipment	N/A
8.5.4.2.1	Safeguards and Safety Interlocks.....	Not such equipment	N/A
8.5.4.2.2	Instructional safeguards against moving parts	No such moving part	N/A



IEC/EN 62368-1			
Clause	Requirement + Test	Result - Remark	Verdict
	Instructional Safeguard	No such moving part	—
8.5.4.2.3	Disconnection from the supply	No such device	N/A
8.5.4.2.4	Probe type and force (N).....	No such device	N/A
8.5.5	High Pressure Lamps	No such device	N/A
8.5.5.1	Energy Source Classification	No such device	N/A
8.5.5.2	High Pressure Lamp Explosion Test.....	No such device	N/A
8.6	Stability	See the following details.	N/A
8.6.1	Product classification	MS1 category of mechanical energy source	N/A
	Instructional Safeguard	No safeguard requirement	—
8.6.2	Static stability	MS1 product classification, no stability requirement	N/A
8.6.2.2	Static stability test	MS1 product classification, no stability requirement	N/A
	Applied Force	MS1 product classification, no stability requirement	—
8.6.2.3	Downward Force Test	MS1 product classification, no stability requirement	N/A
8.6.3	Relocation stability test	MS1 product classification, no stability requirement	N/A
	Unit configuration during 10° tilt.....	MS1 product classification, no such requirement	—
8.6.4	Glass slide test	MS1 product classification, no such requirement	N/A
8.6.5	Horizontal force test (Applied Force).....	MS1 product classification, no such requirement	N/A
	Position of feet or movable parts	MS1 product classification, no such requirement	—
8.7	Equipment mounted to wall or ceiling	No such mounting means	N/A
8.7.1	Mounting Means (Length of screws (mm) and mounting surface)	No such mounting means	N/A
8.7.2	Direction and applied force	No such requirement	N/A
8.8	Handles strength	No such part	N/A
8.8.1	Classification		N/A
8.8.2	Applied Force		N/A
8.9	Wheels or casters attachment requirements	No such part	N/A



IEC/EN 62368-1			
Clause	Requirement + Test	Result - Remark	Verdict
8.9.1	Classification		N/A
8.9.2	Applied force.....:		—
8.10	Carts, stands and similar carriers	No such part	N/A
8.10.1	General		N/A
8.10.2	Marking and instructions		N/A
	Instructional Safeguard		—
8.10.3	Cart, stand or carrier loading test and compliance		N/A
	Applied force.....:		—
8.10.4	Cart, stand or carrier impact test		N/A
8.10.5	Mechanical stability		N/A
	Applied horizontal force (N)		—
8.10.6	Thermoplastic temperature stability (°C)		N/A
8.11	Mounting means for rack mounted equipment	No such mounting means	N/A
8.11.1	General		N/A
8.11.2	Product Classification		N/A
8.11.3	Mechanical strength test, variable <i>N</i>		N/A
8.11.4	Mechanical strength test 250N, including end stops		N/A
8.12	Telescoping or rod antennas	No such part	N/A
	Button/Ball diameter (mm)		—

9	THERMAL BURN INJURY		P
9.2	Thermal energy source classifications	All accessible surfaces are classified as TS1, see appended table 5.4.1.4, 6.3.2, 9.0, B.2.6.	P
9.3	Safeguard against thermal energy sources	No safeguard required for TS1	N/A
9.4	Requirements for safeguards		N/A
9.4.1	Equipment safeguard	No safeguard required for TS1	N/A
9.4.2	Instructional safeguard	No safeguard required for TS1	N/A

10	RADIATION		P
10.2	Radiation energy source classification	See below	P
10.2.1	General classification	RS1 for LED indication light	P



IEC/EN 62368-1			
Clause	Requirement + Test	Result - Remark	Verdict
10.3	Protection against laser radiation	No laser radiation	N/A
	Laser radiation that exists equipment:		—
	Normal, abnormal, single-fault..... :		N/A
	Instructional safeguard :		—
	Tool :		—
10.4	Protection against visible, infrared, and UV radiation		N/A
10.4.1	General		N/A
10.4.1.a)	RS3 for Ordinary and instructed persons :		N/A
10.4.1.b)	RS3 accessible to a skilled person :		N/A
	Personal safeguard (PPE) instructional safeguard :		—
10.4.1.c)	Equipment visible, IR, UV does not exceed RS1 :		N/A
10.4.1.d)	Normal, abnormal, single-fault conditions :		N/A
10.4.1.e)	Enclosure material employed as safeguard is opaque :		N/A
10.4.1.f)	UV attenuation :		N/A
10.4.1.g)	Materials resistant to degradation UV :		N/A
10.4.1.h)	Enclosure containment of optical radiation..... :		N/A
10.4.1.i)	Exempt Group under normal operating conditions :		N/A
10.4.2	Instructional safeguard :		N/A
10.5	Protection against x-radiation	No such part	N/A
10.5.1	X- radiation energy source that exists equipment :		N/A
	Normal, abnormal, single fault conditions		N/A
	Equipment safeguards..... :		N/A
	Instructional safeguard for skilled person :		N/A
10.5.3	Most unfavourable supply voltage to give maximum radiation :		—
	Abnormal and single-fault condition :		N/A
	Maximum radiation (pA/kg)..... :		N/A
10.6	Protection against acoustic energy sources	No acoustic energy sources	N/A
10.6.1	General		N/A



IEC/EN 62368-1

Clause	Requirement + Test	Result - Remark	Verdict
10.6.2	Classification		N/A
	Acoustic output, dB(A)		N/A
	Output voltage, unweighted r.m.s.....		N/A
10.6.4	Protection of persons		N/A
	Instructional safeguards.....		N/A
	Equipment safeguard prevent ordinary person to RS2		—
	Means to actively inform user of increase sound pressure		—
	Equipment safeguard prevent ordinary person to RS2.....		—
10.6.5	Requirements for listening devices (headphones, earphones, etc.)		N/A
10.6.5.1	Corded passive listening devices with analog input		N/A
	Input voltage with 94 dB(A) L_{Aeq} acoustic pressure output.....		—
10.6.5.2	Corded listening devices with digital input		N/A
	Maximum dB(A)		—
10.6.5.3	Cordless listening device		N/A
	Maximum dB(A)		—

B	NORMAL OPERATING CONDITION TESTS, ABNORMAL OPERATING CONDITION TESTS AND SINGLE FAULT CONDITION TESTS		P
B.2	Normal Operating Conditions	See below	P
B.2.1	General requirements	(See Test Item Particulars and appended test tables)	P
	Audio Amplifiers and equipment with audio amplifiers.....	No such part	N/A
B.2.3	Supply voltage and tolerances	5.0Vdc or 6-30Vdc, no tolerances	P
B.2.5	Input test	(See appended table B.2.5)	P
B.3	Simulated abnormal operating conditions		N/A
B.3.1	General requirements	(See appended table B.3)	N/A
B.3.2	Covering of ventilation openings	No such ventilation opening	N/A
B.3.3	D.C. mains polarity test	The EUT is not connected to a D.C. mains	N/A



IEC/EN 62368-1			
Clause	Requirement + Test	Result - Remark	Verdict
B.3.4	Setting of voltage selector	No setting of voltage selector within the EUT	N/A
B.3.5	Maximum load at output terminals.....	No such part	N/A
B.3.6	Reverse battery polarity	No such battery used	N/A
B.3.7	Abnormal operating conditions as specified in Clause E.2.	No such part	N/A
B.3.8	Safeguards functional during and after abnormal operating conditions		N/A
B.4	Simulated single fault conditions		P
B.4.2	Temperature controlling device open or short-circuited.....	(See appended table B.4)	P
B.4.3	Motor tests	No such device	N/A
B.4.3.1	Motor blocked or rotor locked increasing the internal ambient temperature	No such device	N/A
B.4.4	Short circuit of functional insulation	(See appended table B.4)	P
B.4.4.1	Short circuit of clearances for functional insulation	(See appended table B.4)	P
B.4.4.2	Short circuit of creepage distances for functional insulation	(See appended table B.4)	P
B.4.4.3	Short circuit of functional insulation on coated printed boards	No coated printed boards within the EUT	N/A
B.4.5	Short circuit and interruption of electrodes in tubes and semiconductors	(See appended table B.4)	P
B.4.6	Short circuit or disconnect of passive components	(See appended table B.4)	P
B.4.7	Continuous operation of components	The EUT is continuous operating type and no such components intended for short time operation or intermittent operation	N/A
B.4.8	Class 1 and Class 2 energy sources within limits during and after single fault conditions	The accessible part not exceed the energy limit, no flame produce during and after test	P
B.4.9	Battery charging under single fault conditions	See Annex M	P
C	UV RADIATION		N/A
C.1	Protection of materials in equipment from UV radiation	No UV radiation	N/A
C.1.2	Requirements		N/A
C.1.3	Test method		N/A



IEC/EN 62368-1			
Clause	Requirement + Test	Result - Remark	Verdict
C.2	UV light conditioning test		N/A
C.2.1	Test apparatus		N/A
C.2.2	Mounting of test samples		N/A
C.2.3	Carbon-arc light-exposure apparatus		N/A
C.2.4	Xenon-arc light exposure apparatus		N/A
D	TEST GENERATORS		N/A
D.1	Impulse test generators	No such consideration.	N/A
D.2	Antenna interface test generator	No such consideration.	N/A
D.3	Electronic pulse generator	No such consideration.	N/A
E	TEST CONDITIONS FOR EQUIPMENT CONTAINING AUDIO AMPLIFIERS		N/A
E.1	Audio amplifier normal operating conditions	No such part	N/A
	Audio signal voltage (V)	No such part	—
	Rated load impedance (Ω)	No such part	—
E.2	Audio amplifier abnormal operating conditions	No such part	N/A
F	EQUIPMENT MARKINGS, INSTRUCTIONS, AND INSTRUCTIONAL SAFEGUARDS		P
F.1	General requirements		P
	Instructions – Language	English version provided	—
F.2	Letter symbols and graphical symbols	See below for the details.	P
F.2.1	Letter symbols according to IEC60027-1	Complied	P
F.2.2	Graphic symbols IEC, ISO or manufacturer specific	Complied	P
F.3	Equipment markings		P
F.3.1	Equipment marking locations	Marked on the outside of equipment	P
F.3.2	Equipment identification markings	See below	P
F.3.2.1	Manufacturer identification	Trademark: 	—
F.3.2.2	Model identification	Model: ONE523M, ONE524M, ONE523M-NB, ONE524M-NB	—
F.3.3	Equipment rating markings	See below	P
F.3.3.1	Equipment with direct connection to mains	The EUT is not direct connected to mains	N/A
F.3.3.2	Equipment without direct connection to mains	Considered	P



IEC/EN 62368-1

Clause	Requirement + Test	Result - Remark	Verdict
F.3.3.3	Nature of supply voltage	Symbol with “  ” marked following input voltage	—
F.3.3.4	Rated voltage.....	5Vdc or 6-30Vdc	—
F.3.3.4	Rated frequency.....	--	—
F.3.3.6	Rated current or rated power.....	2A	—
F.3.3.7	Equipment with multiple supply connections	Different ratings are marked respectively on the label	P
F.3.4	Voltage setting device	No such device on the equipment.	N/A
F.3.5	Terminals and operating devices	See below	N/A
F.3.5.1	Mains appliance outlet and socket-outlet markings	No such device	N/A
F.3.5.2	Switch position identification marking	No such part	N/A
F.3.5.3	Replacement fuse identification and rating markings	No such part	N/A
F.3.5.4	Replacement battery identification marking.....	No replacement battery	N/A
F.3.5.5	Terminal marking location	No such terminals	N/A
F.3.6	Equipment markings related to equipment classification	See below	N/A
F.3.6.1	Class I Equipment	Class III equipment.	N/A
F.3.6.1.1	Protective earthing conductor terminal	Class III equipment.	N/A
F.3.6.1.2	Neutral conductor terminal	Class III equipment.	N/A
F.3.6.1.3	Protective bonding conductor terminals	Class III equipment.	N/A
F.3.6.2	Class II equipment (IEC60417-5172)	Class III equipment.	N/A
F.3.6.2.1	Class II equipment with or without functional earth	Class III equipment.	N/A
F.3.6.2.2	Class II equipment with functional earth terminal marking	Not such equipment	N/A
F.3.7	Equipment IP rating marking	IP67.	—
F.3.8	External power supply output marking	Not external power supply	N/A
F.3.9	Durability, legibility and permanence of marking	The marking is durable and legible, and can be easily discernible under normal lighting conditions.	P
F.3.10	Test for permanence of markings	After rubbing test by water and petroleum spirit, the label still easily discernible, indelible and legible.	P



IEC/EN 62368-1			
Clause	Requirement + Test	Result - Remark	Verdict
F.4	Instructions		P
	a) Equipment for use in locations where children not likely to be present - marking	Not such equipment	N/A
	b) Instructions given for installation or initial use	Relevant safety caution texts and installation instruction are available.	P
	c) Equipment intended to be fastened in place	Not such equipment	N/A
	d) Equipment intended for use only in restricted access area	Not such equipment	N/A
	e) Audio equipment terminals classified as ES3 and other equipment with terminals marked in accordance F.3.6.1	Not such equipment	N/A
	f) Protective earthing employed as safeguard	Not such equipment	N/A
	g) Protective earthing conductor current exceeding ES 2 limits	Not such equipment	N/A
	h) Symbols used on equipment	Explained in the user manual	P
	i) Permanently connected equipment not provided with all-pole mains switch	Not such equipment	N/A
	j) Replaceable components or modules providing safeguard function	No such part	N/A
F.5	Instructional safeguards	See below	P
	Where "instructional safeguard" is referenced in the test report it specifies the required elements, location of marking and/or instruction	Considered	P
G	COMPONENTS		P
G.1	Switches		N/A
G.1.1	General requirements	No switch used	N/A
G.1.2	Ratings, endurance, spacing, maximum load		N/A
G.2	Relays		N/A
G.2.1	General requirements	No relay used	N/A
G.2.2	Overload test		N/A
G.2.3	Relay controlling connectors supply power		N/A
G.2.4	Mains relay, modified as stated in G.2		N/A
G.3	Protection Devices		N/A
G.3.1	Thermal cut-offs	No such device used	N/A
G.3.1.1a) &b)	Thermal cut-outs separately approved according to IEC 60730 with conditions indicated in a) & b)		N/A



IEC/EN 62368-1			
Clause	Requirement + Test	Result - Remark	Verdict
G.3.1.1c)	Thermal cut-outs tested as part of the equipment as indicated in c)		N/A
G.3.1.2	Thermal cut-off connections maintained and secure		N/A
G.3.2	Thermal links		N/A
G.3.2.1a)	Thermal links separately tested with IEC 60691	No such device	N/A
G.3.2.1b)	Thermal links tested as part of the equipment	No such device	N/A
	Aging hours (H)..... :		—
	Single Fault Condition..... :		—
	Test Voltage (V) and Insulation Resistance (Ω) .:		—
G.3.3	PTC Thermistors	No such device	N/A
G.3.4	Overcurrent protection devices	No such device	N/A
G.3.5	Safeguards components not mentioned in G.3.1 to G.3.5		P
G.3.5.1	Non-resettable devices suitably rated and marking provided	No such device	N/A
G.3.5.2	Single faults conditions :	(See appended Table B.4)	P
G.4	Connectors		N/A
G.4.1	Spacings	No connector used	N/A
G.4.2	Mains connector configuration :		N/A
G.4.3	Plug is shaped that insertion into mains socket-outlets or appliance coupler is unlikely		N/A
G.5	Wound Components		N/A
G.5.1	Wire insulation in wound components	No such part used, (See Annex J)	N/A
G.5.1.2 a)	Two wires in contact inside wound component, angle between 45° and 90°		N/A
G.5.1.2 b)	Construction subject to routine testing		N/A
G.5.2	Endurance test on wound components		N/A
G.5.2.1	General test requirements		N/A
G.5.2.2	Heat run test		N/A
	Time (s)..... :		—
	Temperature (°C)..... :		—
G.5.2.3	Wound Components supplied by mains		N/A
G.5.3	Transformers		N/A
G.5.3.1	Requirements applied (IEC61204-7, IEC61558-1/-2, and/or IEC62368-1)	No such device	N/A



IEC/EN 62368-1

Clause	Requirement + Test	Result - Remark	Verdict
	Position	No such device	—
	Method of protection	No such device	—
G.5.3.2	Insulation	No such device	N/A
	Protection from displacement of windings	No such device	—
G.5.3.3	Overload test.....	No such device	N/A
G.5.3.3.1	Test conditions	No such device	N/A
G.5.3.3.2	Winding Temperatures testing in the unit	No such device	N/A
G.5.3.3.3	Winding Temperatures – Alternative test method	No such device	N/A
G.5.4	Motors		N/A
G.5.4.1	General requirements	No motor used	N/A
	Position		—
G.5.4.2	Test conditions		N/A
G.5.4.3	Running overload test		N/A
G.5.4.4	Locked-rotor overload test		N/A
	Test duration (days)		—
G.5.4.5	Running overload test for d.c. motors in secondary circuits		N/A
G.5.4.5.2	Tested in the unit		N/A
	Electric strength test (V)		—
G.5.4.5.3	Tested on the Bench – Alternative test method; test time (h)		N/A
	Electric strength test (V)		—
G.5.4.6	Locked-rotor overload test for d.c. motors in secondary circuits		N/A
G.5.4.6.2	Tested in the unit		N/A
	Maximum Temperature		N/A
	Electric strength test (V)		N/A
G.5.4.6.3	Tested on the bench – Alternative test method; test time (h)		N/A
	Electric strength test (V)		N/A
G.5.4.7	Motors with capacitors		N/A
G.5.4.8	Three-phase motors		N/A
G.5.4.9	Series motors		N/A
	Operating voltage		—



IEC/EN 62368-1			
Clause	Requirement + Test	Result - Remark	Verdict
G.6	Wire Insulation		N/A
G.6.1	General	No such insulation required	N/A
G.6.2	Solvent-based enamel wiring insulation	No such part used for insulation	N/A
G.7	Mains supply cords		N/A
G.7.1	General requirements	No such part	N/A
	Type	No such part	—
	Rated current (A)	No such part	—
	Cross-sectional area (mm ²), (AWG)	No such part	—
G.7.2	Compliance and test method	No such part	N/A
G.7.3	Cord anchorages and strain relief for non-detachable power supply cords	No such part	N/A
G.7.3.2	Cord strain relief	No such part	N/A
G.7.3.2.1	Requirements	No such part	N/A
	Strain relief test force (N)	No such part	—
G.7.3.2.2	Strain relief mechanism failure	No such part	N/A
G.7.3.2.3	Cord sheath or jacket position, distance (mm) ...	No such part	—
G.7.3.2.4	Strain relief comprised of polymeric material	No such part	N/A
G.7.4	Cord Entry	No such part	N/A
G.7.5	Non-detachable cord bend protection	No such part	N/A
G.7.5.1	Requirements	No such part	N/A
G.7.5.2	Mass (g)		—
	Diameter (m)		—
	Temperature (°C)		—
G.7.6	Supply wiring space		N/A
G.7.6.2	Stranded wire		N/A
G.7.6.2.1	Test with 8 mm strand		N/A
G.8	Varistors		N/A
G.8.1	General requirements	No varistor used	N/A
G.8.2	Safeguard against shock		N/A
G.8.3	Safeguard against fire		N/A
G.8.3.2	Varistor overload test	(See appended table B.3)	N/A
G.8.3.3	Temporary overvoltage	(See appended table B.3)	N/A
G.9	Integrated Circuit (IC) Current Limiters		N/A



IEC/EN 62368-1			
Clause	Requirement + Test	Result - Remark	Verdict
G.9.1 a)	Manufacturer defines limit at max. 5A.	No such device used	N/A
G.9.1 b)	Limiters do not have manual operator or reset		N/A
G.9.1 c)	Supply source does not exceed 250 VA :		—
G.9.1 d)	IC limiter output current (max. 5A) :		—
G.9.1 e)	Manufacturers' defined drift :		—
G.9.2	Test Program 1		N/A
G.9.3	Test Program 2		N/A
G.9.4	Test Program 3		N/A
G.10	Resistors		N/A
G.10.1	General requirements	No such component	N/A
G.10.2	Resistor test		N/A
G.10.3	Test for resistors serving as safeguards between the mains and an external circuit consisting of a coaxial cable		N/A
G.10.3.1	General requirements		N/A
G.10.3.2	Voltage surge test		N/A
G.10.3.3	Impulse test		N/A
G.11	Capacitor and RC units		N/A
G.11.1	General requirements	No such component	N/A
G.11.2	Conditioning of capacitors and RC units		N/A
G.11.3	Rules for selecting capacitors		N/A
G.12	Optocouplers		N/A
	Optocouplers comply with IEC 60747-5-5:2007 Spacing or Electric Strength Test (specify option and test results) :	No such component	N/A
	Type test voltage Vini :		—
	Routine test voltage, Vini,b :		—
G.13	Printed boards		N/A
G.13.1	General requirements	No such part used	N/A
G.13.2	Uncoated printed boards		N/A
G.13.3	Coated printed boards		N/A
G.13.4	Insulation between conductors on the same inner surface		N/A
	Compliance with cemented joint requirements (Specify construction) :		—



IEC/EN 62368-1			
Clause	Requirement + Test	Result - Remark	Verdict
G.13.5	Insulation between conductors on different surfaces		N/A
	Distance through insulation	(See appended table 5.4.4.5)	N/A
	Number of insulation layers (pcs)		—
G.13.6	Tests on coated printed boards		N/A
G.13.6.1	Sample preparation and preliminary inspection		N/A
G.13.6.2a)	Thermal conditioning		N/A
G.13.6.2b)	Electric strength test		N/A
G.13.6.2c)	Abrasion resistance test		N/A
G.14	Coating on components terminals		N/A
G.14.1	Requirements	No such coating used	N/A
G.15	Liquid filled components		N/A
G.15.1	General requirements	No such component used	N/A
G.15.2	Requirements		N/A
G.15.3	Compliance and test methods		N/A
G.15.3.1	Hydrostatic pressure test		N/A
G.15.3.2	Creep resistance test		N/A
G.15.3.3	Tubing and fittings compatibility test		N/A
G.15.3.4	Vibration test		N/A
G.15.3.5	Thermal cycling test		N/A
G.15.3.6	Force test		N/A
G.15.4	Compliance		N/A
G.16	IC including capacitor discharge function (ICX)		N/A
a)	Humidity treatment in accordance with sc5.4.8 – 120 hours	No such component used	N/A
b)	Impulse test using circuit 2 with $U_c =$ to transient voltage		N/A
C1)	Application of ac voltage at 110% of rated voltage for 2.5 minutes		N/A
C2)	Test voltage		—
D1)	10,000 cycles on and off using capacitor with smallest capacitance resistor with largest resistance specified by manufacturer		N/A
D2)	Capacitance		—
D3)	Resistance		—



IEC/EN 62368-1

Clause	Requirement + Test	Result - Remark	Verdict
H	CRITERIA FOR TELEPHONE RINGING SIGNALS		N/A
H.1	General	No such ringing signal	N/A
H.2	Method A	No such ringing signal	N/A
H.3	Method B	No such ringing signal	N/A
H.3.1	Ringling signal	No such ringing signal	N/A
H.3.1.1	Frequency (Hz)	No such ringing signal	—
H.3.1.2	Voltage (V)	No such ringing signal	—
H.3.1.3	Cadence; time (s) and voltage (V)	No such ringing signal	—
H.3.1.4	Single fault current (Ma):	No such ringing signal	—
H.3.2	Tripping device and monitoring voltage.....	No such ringing signal	N/A
H.3.2.1	Conditions for use of a tripping device or a monitoring voltage complied with	No such ringing signal	N/A
H.3.2.2	Tripping device	No such ringing signal	N/A
H.3.2.3	Monitoring voltage (V).....	No such ringing signal	—
J	INSULATED WINDING WIRES FOR USE WITHOUT INTERLEAVED INSULATION		N/A
	General requirements	No such part used	N/A
K	SAFETY INTERLOCKS		N/A
K.1	General requirements	No such device	N/A
K.2	Components of safety interlock safeguard mechanism	(See Annex G)	N/A
K.3	Inadvertent change of operating mode		N/A
K.4	Interlock safeguard override		N/A
K.5	Fail-safe		N/A
	Compliance.....	(See appended table B.4)	N/A
K.6	Mechanically operated safety interlocks		N/A
K.6.1	Endurance requirement		N/A
K.6.2	Compliance and Test method.....		N/A
K.7	Interlock circuit isolation		N/A
K.7.1	Separation distance for contact gaps & interlock circuit elements (type and circuit location)		N/A
K.7.2	Overload test, Current (A)		N/A
K.7.3	Endurance test		N/A
K.7.4	Electric strength test	(See appended table 5.4.11)	N/A



IEC/EN 62368-1			
Clause	Requirement + Test	Result - Remark	Verdict
L	DISCONNECT DEVICES		N/A
L.1	General requirements	The EUT is not directly connected to mains	N/A
L.2	Permanently connected equipment	Not such equipment	N/A
L.3	Parts that remain energized	The EUT is not directly connected to mains	N/A
L.4	Single phase equipment	The EUT is not directly connected to mains	N/A
L.5	Three-phase equipment	Not such equipment	N/A
L.6	Switches as disconnect devices	No such device	N/A
L.7	Plugs as disconnect devices	The EUT is not directly connected to mains	N/A
L.8	Multiple power sources	The EUT is not directly connected to mains	N/A
M	EQUIPMENT CONTAINING BATTERIES AND THEIR PROTECTION CIRCUITS		P
M.1	General requirements	See below	P
M.2	Safety of batteries and their cells	See below	P
M.2.1	Requirements	The approved battery used	P
M.2.2	Compliance and test method (identify method) ...:	The approved battery used	P
M.3	Protection circuits	See below	P
M.3.1	Requirements	See below	P
M.3.2	Tests	See below	P
	- Overcharging of a rechargeable battery	(See appended table Annex M)	P
	- Unintentional charging of a non-rechargeable battery	No non-rechargeable battery used	N/A
	- Reverse charging of a rechargeable battery	Impossible to reverse charging	N/A
	- Excessive discharging rate for any battery	(See appended table Annex M)	P
M.3.3	Compliance	No any risk	P
M.4	Additional safeguards for equipment containing secondary lithium battery	See below	P
M.4.1	General	See below	P
M.4.2	Charging safeguards	See below	P
M.4.2.1	Charging operating limits	(See appended table Annex M.4)	P
M.4.2.2a)	Charging voltage, current and temperature..... :	(See appended table Annex M.4)	—
M.4.2.2 b)	Single faults in charging circuitry	(See appended table Annex M.4)	—



IEC/EN 62368-1			
Clause	Requirement + Test	Result - Remark	Verdict
M.4.3	Fire Enclosure	V-0 plastic enclosure used, see clause 6.4.8	P
M.4.4	Endurance of equipment containing a secondary lithium battery	See below	P
M.4.4.2	Preparation	Two batteries are fully charged at the same time under the same charging conditions. The initial open circuit voltages of both batteries are the same.	P
M.4.4.3	Drop and charge/discharge function tests	See below	P
	Drop	Three drop at the height of 1000mm. The voltage difference not exceed 5% after test	P
	Charge	The charge function can operate and all safeguards are effective	P
	Discharge	The discharge function can operate and all safeguards are effective	P
M.4.4.4	Charge-discharge cycle test	Considered	P
M.4.4.5	Result of charge-discharge cycle test	No hazard during test	P
M.4.4.6	Compliance criteria	No such risk of burn	P
M.5	Risk of burn due to short circuit during carrying	See below	P
M.5.1	Requirement	Complied	P
M.5.2	Compliance and Test Method (Test of P.2.3)	No chemical leaks or explosion, no emission of flame or expulsion of molten metal during test	P
M.6	Prevention of short circuits and protection from other effects of electric current	See below	P
M.6.1	Short circuits	The internal fault testing has been evaluated in the battery cell's test report	P
M.6.1.1	General requirements		N/A
M.6.1.2	Test method to simulate an internal fault		N/A
M.6.2	Leakage current (Ma)		N/A
M.7	Risk of explosion from lead acid and NiCd batteries	No such battery used	N/A
M.7.1	Ventilation preventing explosive gas concentration	No such battery used	N/A
M.7.2	Compliance and test method	No such battery used	N/A



IEC/EN 62368-1			
Clause	Requirement + Test	Result - Remark	Verdict
M.8	Protection against internal ignition from external spark sources of lead acid batteries	No such battery used	N/A
M.8.1	General requirements	No such battery used	N/A
M.8.2	Test method	No such battery used	N/A
M.8.2.1	General requirements	No such battery used	N/A
M.8.2.2	Estimation of hypothetical volume V_z (m ³ /s)		—
M.8.2.3	Correction factors		—
M.8.2.4	Calculation of distance d (mm)		—
M.9	Preventing electrolyte spillage	See below	P
M.9.1	Protection from electrolyte spillage	The metallic enclosure of battery used as container	P
M.9.2	Tray for preventing electrolyte spillage	The metallic enclosure of battery used as container	P
M.10	Instructions to prevent reasonably foreseeable misuse (Determination of compliance: inspection, data review; or abnormal testing)	Instructional safeguards provided in the user manual	P
N	ELECTROCHEMICAL POTENTIALS		N/A
	Metal(s) used		—
O	MEASUREMENT OF CREEPAGE DISTANCES AND CLEARANCES		N/A
	Figures O.1 to O.20 of this Annex applied		—
P	SAFEGUARDS AGAINST ENTRY OF FOREIGN OBJECTS AND SPILLAGE OF INTERNAL LIQUIDS		P
P.1	General requirements		P
P.2.2	Safeguards against entry of foreign object	No any opening	P
	Location and Dimensions (mm)	No any opening	—
P.2.3	Safeguard against the consequences of entry of foreign object	Comply with the requirement of clause P.2.2	N/A
P.2.3.1	Safeguards against the entry of a foreign object		N/A
	Openings in transportable equipment		N/A
	Transportable equipment with metalized plastic parts		N/A
P.2.3.2	Openings in transportable equipment in relation to metalized parts of a barrier or enclosure (identification of supplementary safeguard)		N/A
P.3	Safeguards against spillage of internal liquids	No liquid used in the equipment	N/A
P.3.1	General requirements		N/A



IEC/EN 62368-1			
Clause	Requirement + Test	Result - Remark	Verdict
P.3.2	Determination of spillage consequences		N/A
P.3.3	Spillage safeguards		N/A
P.3.4	Safeguards effectiveness		N/A
P.4	Metallized coatings and adhesive securing parts	No such part	N/A
P.4.2 a)	Conditioning testing		N/A
	Tc (°C)		—
	Tr (°C)		—
	Ta (°C)		—
P.4.2 b)	Abrasion testing	(See G.13.6.2)	N/A
P.4.2 c)	Mechanical strength testing	(See Annex T)	N/A
Q	CIRCUITS INTENDED FOR INTERCONNECTION WITH BUILDING WIRING		N/A
Q.1	Limited power sources		N/A
Q.1.1 a)	Inherently limited output		N/A
Q.1.1 b)	Impedance limited output	See appended table Annex Q.1	N/A
	- Regulating network limited output under normal operating and simulated single fault condition		N/A
Q.1.1 c)	Overcurrent protective device limited output		N/A
Q.1.1 d)	IC current limiter complying with G.9		N/A
Q.1.2	Compliance and test method		N/A
Q.2	Test for external circuits – paired conductor cable		N/A
	Maximum output current (A)	See appended table Annex Q.1	—
	Current limiting method		—
R	LIMITED SHORT CIRCUIT TEST		N/A
R.1	General requirements		N/A
R.2	Determination of the overcurrent protective device and circuit		N/A
R.3	Test method Supply voltage (V) and short-circuit current (A).		N/A
S	TESTS FOR RESISTANCE TO HEAT AND FIRE		N/A
S.1	Flammability test for fire enclosures and fire barrier materials of equipment where the steady state power does not exceed 4 000 W	Not used	N/A
	Samples, material		—
	Wall thickness (mm)		—



IEC/EN 62368-1			
Clause	Requirement + Test	Result - Remark	Verdict
	Conditioning (°C)		—
	Test flame according to IEC 60695-11-5 with conditions as set out		N/A
	- Material not consumed completely		N/A
	- Material extinguishes within 30s		N/A
	- No burning of layer or wrapping tissue		N/A
S.2	Flammability test for fire enclosure and fire barrier integrity		N/A
	Samples, material		—
	Wall thickness (mm)		—
	Conditioning (°C)		—
	Test flame according to IEC 60695-11-5 with conditions as set out		N/A
	Test specimen does not show any additional hole		N/A
S.3	Flammability test for the bottom of a fire enclosure		N/A
	Samples, material		—
	Wall thickness (mm)		—
	Cheesecloth did not ignite		N/A
S.4	Flammability classification of materials		N/A
S.5	Flammability test for fire enclosures and fire barrier materials of equipment where the steady state power does not exceed 4 000 W		N/A
	Samples, material		—
	Wall thickness (mm)		—
	Conditioning (test condition), (°C).....		—
	Test flame according to IEC 60695-11-20 with conditions as set out		N/A
	After every test specimen was not consumed completely		N/A
	After fifth flame application, flame extinguished within 1 min		N/A
T	MECHANICAL STRENGTH TESTS		P
T.1	General requirements		P
T.2	Steady force test, 10 N		N/A
T.3	Steady force test, 30 N		N/A



IEC/EN 62368-1

Clause	Requirement + Test	Result - Remark	Verdict
T.4	Steady force test, 100 N	(See appended table T.4)	P
T.5	Steady force test, 250 N		N/A
T.6	Enclosure impact test		N/A
	Fall test		N/A
	Swing test		N/A
T.7	Drop test	(See appended table T.7)	P
T.8	Stress relief test	(See appended table T.8)	P
T.9	Impact Test (glass)	No such part	N/A
T.9.1	General requirements		N/A
T.9.2	Impact test and compliance		N/A
	Impact energy (J)	Not suitable	—
	Height (m).....	Not suitable	—
T.10	Glass fragmentation test.....	No such part	N/A
T.11	Test for telescoping or rod antennas	No such part	N/A
	Torque value (Nm)		—
U	MECHANICAL STRENGTH OF CATHODE RAY TUBES (CRT) AND PROTECTION AGAINST THE EFFECTS OF IMPLOSION		N/A
U.1	General requirements	No cathode ray tube used	N/A
U.2	Compliance and test method for non-intrinsically protected CRTs		N/A
U.3	Protective Screen	(See Annex T)	N/A
V	DETERMINATION OF ACCESSIBLE PARTS (FINGERS, PROBES AND WEDGES)		P
V.1	Accessible parts of equipment	Considered	P
V.2	Accessible part criterion	Considered	P



IEC/EN 62368-1			
Clause	Requirement + Test	Result - Remark	Verdict

ATTACHMENT TO TEST REPORT
IEC 62368-1
EUROPEAN GROUP DIFFERENCES AND NATIONAL DIFFERENCES
 (Audio/video, information and communication technology equipment – Part 1: Safety requirements)

Differences according to	EN 62368-1:2014+A11:2017
Attachment Form No.	EU_GD_IEC62368_1B_II
Attachment Originator	Nemko AS
Master Attachment	Date 2017-09-22

Copyright © 2017 IEC System for Conformity Testing and Certification of Electrical Equipment (IECEE), Geneva, Switzerland. All rights reserved.

	CENELEC COMMON MODIFICATIONS (EN)	P																																				
	Clauses, subclauses, notes, tables, figures and annexes which are additional to those in IEC 62368-1:2014 are prefixed "Z".	P																																				
Contents	Add the following annexes: Annex ZA (normative) Normative references to international publications with their corresponding European publications Annex ZB (normative) Special national conditions Annex ZC (informative) A-deviations Annex ZD (informative) IEC and CENELEC code designations for flexible cords	P																																				
	Delete all the "country" notes in the reference document (IEC 62368-1:2014) according to the following list: <table border="1" data-bbox="311 1339 1295 1803"> <tr> <td>0.2.1</td> <td>Note</td> <td>1</td> <td>Note 3</td> <td>4.1.15</td> <td>Note</td> </tr> <tr> <td>4.7.3</td> <td>Note 1 and 2</td> <td>5.2.2.2</td> <td>Note</td> <td>5.4.2.3.2.2 Table 13</td> <td>Note c</td> </tr> <tr> <td>5.4.2.3.2.4</td> <td>Note 1 and 3</td> <td>5.4.2.5</td> <td>Note 2</td> <td>5.4.5.1</td> <td>Note</td> </tr> <tr> <td>5.5.2.1</td> <td>Note</td> <td>5.5.6</td> <td>Note</td> <td>5.6.4.2.1</td> <td>Note 2 and 3</td> </tr> <tr> <td>5.7.5</td> <td>Note</td> <td>5.7.6.1</td> <td>Note 1 and 2</td> <td>10.2.1 Table 39</td> <td>Note 2, 3 and 4</td> </tr> <tr> <td>10.5.3</td> <td>Note 2</td> <td>10.6.2.1</td> <td>Note 3</td> <td>F.3.3.6</td> <td>Note 3</td> </tr> </table>	0.2.1	Note	1	Note 3	4.1.15	Note	4.7.3	Note 1 and 2	5.2.2.2	Note	5.4.2.3.2.2 Table 13	Note c	5.4.2.3.2.4	Note 1 and 3	5.4.2.5	Note 2	5.4.5.1	Note	5.5.2.1	Note	5.5.6	Note	5.6.4.2.1	Note 2 and 3	5.7.5	Note	5.7.6.1	Note 1 and 2	10.2.1 Table 39	Note 2, 3 and 4	10.5.3	Note 2	10.6.2.1	Note 3	F.3.3.6	Note 3	P
0.2.1	Note	1	Note 3	4.1.15	Note																																	
4.7.3	Note 1 and 2	5.2.2.2	Note	5.4.2.3.2.2 Table 13	Note c																																	
5.4.2.3.2.4	Note 1 and 3	5.4.2.5	Note 2	5.4.5.1	Note																																	
5.5.2.1	Note	5.5.6	Note	5.6.4.2.1	Note 2 and 3																																	
5.7.5	Note	5.7.6.1	Note 1 and 2	10.2.1 Table 39	Note 2, 3 and 4																																	
10.5.3	Note 2	10.6.2.1	Note 3	F.3.3.6	Note 3																																	
	For special national conditions, see Annex ZB.	N/A																																				
1	Add the following note: NOTE Z1 The use of certain substances in electrical and electronic equipment is restricted within the EU: see Directive 2011/65/EU.	N/A																																				



IEC/EN 62368-1

Clause	Requirement + Test	Result - Remark	Verdict
4.Z1	<p>Add the following new subclause after 4.9:</p> <p>To protect against excessive current, short-circuits and earth faults in circuits connected to an a.c. mains, protective devices shall be included either as integral parts of the equipment or as parts of the building installation, subject to the following, a), b) and c):</p> <p>a) except as detailed in b) and c), protective devices necessary to comply with the requirements of B.3.1 and B.4 shall be included as parts of the equipment;</p> <p>b) for components in series with the mains input to the equipment such as the supply cord, appliance coupler, r.f.i. filter and switch, short-circuit and earth fault protection may be provided by protective devices in the building installation;</p> <p>c) it is permitted for pluggable equipment type B or permanently connected equipment, to rely on dedicated overcurrent and short-circuit protection in the building installation, provided that the means of protection, e.g. fuses or circuit breakers, is fully specified in the installation instructions.</p> <p>If reliance is placed on protection in the building installation, the installation instructions shall so state, except that for pluggable equipment type A the building installation shall be regarded as providing protection in accordance with the rating of the wall socket outlet.</p>	Class III equipment, no such part	N/A
5.4.2.3.2.4	<p>Add the following to the end of this subclause:</p> <p>The requirement for interconnection with external circuit is in addition given in EN 50491-3:2009.</p>	Not connected to such external circuit	N/A
10.2.1	<p>Add the following to c) and d) in table 39:</p> <p>For additional requirements, see 10.5.1.</p>	Added	N/A



IEC/EN 62368-1

Clause	Requirement + Test	Result - Remark	Verdict
10.5.1	<p>Add the following after the first paragraph: <i>For RS 1 compliance is checked by measurement under the following conditions:</i> <i>In addition to the normal operating conditions, all controls adjustable from the outside by hand, by any object such as a tool or a coin, and those internal adjustments or presets which are not locked in a reliable manner, are adjusted so as to give maximum radiation whilst maintaining an intelligible picture for 1 h, at the end of which the measurement is made.</i></p> <p>NOTE Z1 Soldered joints and paint lockings are examples of adequate locking.</p> <p><i>The dose-rate is determined by means of a radiation monitor with an effective area of 10 cm², at any point 10 cm from the outer surface of the apparatus.</i></p> <p><i>Moreover, the measurement shall be made under fault conditions causing an increase of the high-voltage, provided an intelligible picture is maintained for 1 h, at the end of which the measurement is made.</i></p> <p><i>For RS1, the dose-rate shall not exceed 1 µSv/h taking account of the background level.</i></p> <p>NOTE Z2 These values appear in Directive 96/29/Euratom of 13 May 1996.</p>	No such radiation generated from the equipment.	N/A
10.6.1	<p>Add the following paragraph to the end of the subclause: EN 71-1:2011, 4.20 and the related tests methods and measurement distances apply.</p>	No acoustic energy sources	N/A
10.Z1	<p>Add the following new subclause after 10.6.5. 10.Z1 Non-ionizing radiation from radio frequencies in the range 0 to 300 GHz The amount of non-ionizing radiation is regulated by European Council Recommendation 1999/519/EC of 12 July 1999 on the limitation of exposure of the general public to electromagnetic fields (0 Hz to 300 GHz). For intentional radiators, ICNIRP guidelines should be taken into account for Limiting Exposure to Time-Varying Electric, Magnetic, and Electromagnetic Fields (up to 300 GHz). For hand-held and body-mounted devices, attention is drawn to EN 50360 and EN 50566</p>	No such radiation generated from the equipment.	N/A
G.7.1	<p>Add the following note: NOTE Z1 The harmonized code designations corresponding to the IEC cord types are given in Annex ZD.</p>	Added	N/A



IEC/EN 62368-1			
Clause	Requirement + Test	Result - Remark	Verdict
Bibliography	<p>Add the following standards:</p> <p>Add the following notes for the standards indicated:</p> <p>IEC 60130-9 NOTE Harmonized as EN 60130-9.</p> <p>IEC 60269-2 NOTE Harmonized as HD 60269-2.</p> <p>IEC 60309-1 NOTE Harmonized as EN 60309-1.</p> <p>IEC 60364 NOTE some parts harmonized in HD 384/HD 60364 series.</p> <p>IEC 60601-2-4 NOTE Harmonized as EN 60601-2-4.</p> <p>IEC 60664-5 NOTE Harmonized as EN 60664-5.</p> <p>IEC 61032:1997 NOTE Harmonized as EN 61032:1998 (not modified).</p> <p>IEC 61508-1 NOTE Harmonized as EN 61508-1.</p> <p>IEC 61558-2-1 NOTE Harmonized as EN 61558-2-1.</p> <p>IEC 61558-2-4 NOTE Harmonized as EN 61558-2-4.</p> <p>IEC 61558-2-6 NOTE Harmonized as EN 61558-2-6.</p> <p>IEC 61643-1 NOTE Harmonized as EN 61643-1.</p> <p>IEC 61643-21 NOTE Harmonized as EN 61643-21.</p> <p>IEC 61643-311 NOTE Harmonized as EN 61643-311.</p> <p>IEC 61643-321 NOTE Harmonized as EN 61643-321.</p> <p>IEC 61643-331 NOTE Harmonized as EN 61643-331.</p>		N/A
ZB	ANNEX ZB, SPECIAL NATIONAL CONDITIONS (EN)		N/A
4.1.15	<p>Denmark, Finland, Norway and Sweden</p> <p>To the end of the subclause the following is added:</p> <p>Class I pluggable equipment type A intended for connection to other equipment or a network shall, if safety relies on connection to reliable earthing or if surge suppressors are connected between the network terminals and accessible parts, have a marking stating that the equipment shall be connected to an earthed mains socket-outlet.</p> <p>The marking text in the applicable countries shall be as follows:</p> <p>In Denmark: "Apparatets stikprop skal tilsluttes en stikkontakt med jord som giver forbindelse til stikproppens jord."</p> <p>In Finland: "Laite on liitettävä suojakoskettimilla varustettuun pistorasiaan"</p> <p>In Norway: "Apparatet må tilkoples jordet stikkontakt"</p> <p>In Sweden: "Apparaten skall anslutas till jordat uttag"</p>	Class III equipment	N/A



**BUREAU
VERITAS**

Test Report No: RD2009WDG0430

IEC/EN 62368-1

Clause	Requirement + Test	Result - Remark	Verdict
4.7.3	United Kingdom To the end of the subclause the following is added: The torque test is performed using a socket-outlet complying with BS 1363, and the plug part shall be assessed to the relevant clauses of BS 1363. Also see Annex G.4.2 of this annex	No such part	N/A
5.2.2.2	Denmark After the 2 nd paragraph add the following: A warning (marking safeguard) for high touch current is required if the touch current exceeds the limits of 3,5 Ma a.c. or 10 Ma d.c.	Class III equipment	N/A



IEC/EN 62368-1

Clause	Requirement + Test	Result - Remark	Verdict
5.4.11.1 and Annex G	<p>Finland and Sweden</p> <p>To the end of the subclause the following is added: For separation of the telecommunication network from earth the following is applicable: If this insulation is solid, including insulation forming part of a component, it shall at least consist of either</p> <ul style="list-style-type: none"> • two layers of thin sheet material, each of which shall pass the electric strength test below, or • one layer having a distance through insulation of at least 0,4 mm, which shall pass the electric strength test below. <p>If this insulation forms part of a semiconductor component (e.g. an optocoupler), there is no distance through insulation requirement for the insulation consisting of an insulating compound completely filling the casing, so that clearances and creepage distances do not exist, if the component passes the electric strength test in accordance with the compliance clause below and in addition</p> <ul style="list-style-type: none"> • passes the tests and inspection criteria of 5.4.8 with an electric strength test of 1,5 Kv multiplied by 1,6 (the electric strength test of 5.4.9 shall be performed using 1,5 Kv), and • is subject to routine testing for electric strength during manufacturing, using a test voltage of 1,5Kv. <p>It is permitted to bridge this insulation with a capacitor complying with EN 60384-14:2005, subclass Y2.</p> <p>A capacitor classified Y3 according to EN 60384-14:2005, may bridge this insulation under the following conditions:</p> <ul style="list-style-type: none"> • the insulation requirements are satisfied by having a capacitor classified Y3 as defined by EN 60384-14, which in addition to the Y3 testing, is tested with an impulse test of 2,5 Kv defined in 5.4.11; • the additional testing shall be performed on all the test specimens as described in EN 60384-14; the impulse test of 2,5 Kv is to be performed before the endurance test in EN 60384-14, in the sequence of tests as described in EN 60384-14. 	The EUT does not intend to be connected with telecommunication network	N/A



IEC/EN 62368-1

Clause	Requirement + Test	Result - Remark	Verdict
5.5.2.1	Norway After the 3 rd paragraph the following is added: Due to the IT power system used, capacitors are required to be rated for the applicable line-to-line voltage (230 V).	Class III equipment	N/A
5.5.6	Finland, Norway and Sweden To the end of the subclause the following is added: Resistors used as basic safeguard or bridging basic insulation in class I pluggable equipment type A shall comply with G.10.1 and the test of G.10.2.	No such devices	N/A
5.6.1	Denmark Add to the end of the subclause Due to many existing installations where the socket-outlets can be protected with fuses with higher rating than the rating of the socket-outlets the protection for pluggable equipment type A shall be an integral part of the equipment. <i>Justification:</i> In Denmark an existing 13 A socket outlet can be protected by a 20 A fuse.	Class III equipment, no such part	N/A
5.6.4.2.1	Ireland and United Kingdom After the indent for pluggable equipment type A , the following is added: – the protective current rating is taken to be 13 A, this being the largest rating of fuse used in the mains plug.	Class III equipment, no such part	N/A
5.6.5.1	To the second paragraph the following is added: The range of conductor sizes of flexible cords to be accepted by terminals for equipment with a rated current over 10 A and up to and including 13 A is: 1,25 mm ² to 1,5 mm ² in cross-sectional area.	Class III equipment, no such part	N/A
5.7.5	Denmark To the end of the subclause the following is added: The installation instruction shall be affixed to the equipment if the protective conductor current exceeds the limits of 3,5 Ma a.c. or 10 Ma d.c.	Class III equipment, no such part	N/A



IEC/EN 62368-1

Clause	Requirement + Test	Result - Remark	Verdict
5.7.6.1	<p>Norway and Sweden</p> <p>To the end of the subclause the following is added: The screen of the television distribution system is normally not earthed at the entrance of the building and there is normally no equipotential bonding system within the building. Therefore the protective earthing of the building installation needs to be isolated from the screen of a cable distribution system.</p> <p>It is however accepted to provide the insulation external to the equipment by an adapter or an interconnection cable with galvanic isolator, which may be provided by a retailer, for example.</p> <p>The user manual shall then have the following or similar information in Norwegian and Swedish language respectively, depending on in what country the equipment is intended to be used in: “Apparatus connected to the protective earthing of the building installation through the mains connection or through other apparatus with a connection to protective earthing – and to a television distribution system using coaxial cable, may in some circumstances create a fire hazard. Connection to a television distribution system therefore has to be provided through a device providing electrical isolation below a certain frequency range (galvanic isolator, see EN 60728-11)”</p> <p>NOTE In Norway, due to regulation for CATV-installations, and in Sweden, a galvanic isolator shall provide electrical insulation below 5 MHz. The insulation shall withstand a dielectric strength of 1,5 Kv r.m.s., 50 Hz or 60 Hz, for 1 min.</p> <p>Translation to Norwegian (the Swedish text will also be accepted in Norway): “Apparater 47isa47I koplet til beskyttelsesjord via nettplugg og/eller via annet jordtilkoplet utstyr – og er tilkoplet et koaksialbasert kabel-TV nett, kan forårsake brannfare. For å unngå dette 47isa47Ile ved tilkopling av apparater til kabel-TV nett 47isa47IIers en galvanisk isolator mellom apparatet og kabel-TV nettet.”</p> <p>Translation to Swedish: ”Apparater som är kopplad till skyddsjord via jordat vägguttag och/eller via annan utrustning och samtidigt är kopplad till kabel-TV nät kan i 47isa fall medföra risk för brand. För att undvika detta skall vid anslutning av apparaten till kabel-TV nät</p>	Not such equipment	N/A



**BUREAU
VERITAS**

Test Report No: RD2009WDG0430

IEC/EN 62368-1

Clause	Requirement + Test	Result - Remark	Verdict
	galvanisk isolator finnas mellan apparaten och kabel-TV nätet.”.		
5.7.6.2	Denmark To the end of the subclause the following is added: The warning (marking safeguard) for high touch current is required if the touch current or the protective current exceed the limits of 3,5 Ma .	Class III equipment, no such part	N/A
B.3.1 and B.4	Ireland and United Kingdom The following is applicable: To protect against excessive currents and short-circuits in the primary circuit of direct plug-in equipment , tests according to Annexes B.3.1 and B.4 shall be conducted using an external miniature circuit breaker complying with EN 60898-1, Type B, rated 32A. If the equipment does not pass these tests, suitable protective devices shall be included as an integral part of the direct plug-in equipment , until the requirements of Annexes B.3.1 and B.4 are met	Not such equipment	N/A



IEC/EN 62368-1

Clause	Requirement + Test	Result - Remark	Verdict
G.4.2	<p>Denmark</p> <p>To the end of the subclause the following is added: Supply cords of single phase appliances having a rated current not exceeding 13 A shall be provided with a plug according to DS 60884-2-D1:2011.</p> <p>CLASS I EQUIPMENT provided with socket-outlets with earth contacts or which are intended to be used in locations where protection against indirect contact is required according to the wiring rules shall be provided with a plug in accordance with standard sheet DK 2-1a or DK 2-5a.</p> <p>If a single-phase equipment having a RATED CURRENT exceeding 13 A or if a poly-phase equipment is provided with a supply cord with a plug, this plug shall be in accordance with the standard sheets DK 6-1a in DS 60884-2-D1 or EN 60309-2.</p> <p>Mains socket outlets intended for providing power to Class II apparatus with a rated current of 2,5 A shall be in accordance DS 60884-2-D1:2011 standard sheet DKA 1-4a.</p> <p>Other current rating socket outlets shall be in compliance with Standard Sheet DKA 1-3a or DKA 1-1c.</p> <p>Mains socket-outlets with earth shall be in compliance with DS 60884-2-D1:2011 Standard Sheet DK 1-3a, DK 1-1c, DK1-1d, DK 1-5a or DK 1-7a</p> <p><i>Justification:</i> Heavy Current Regulations, Section 6c</p>	Class III equipment, no such part	N/A
G.4.2	<p>United Kingdom</p> <p>To the end of the subclause the following is added: The plug part of direct plug-in equipment shall be assessed to BS 1363: Part 1, 12.1, 12.2, 12.3, 12.9, 12.11, 12.12, 12.13, 12.16, and 12.17, except that the test of 12.17 is performed at not less than 125 °C. Where the metal earth pin is replaced by an Insulated Shutter Opening Device (ISOD), the requirements of clauses 22.2 and 23 also apply.</p>	Not such equipment	N/A



IEC/EN 62368-1			
Clause	Requirement + Test	Result - Remark	Verdict
G.7.1	<p>United Kingdom</p> <p>To the first paragraph the following is added: Equipment which is fitted with a flexible cable or cord and is designed to be connected to a mains socket conforming to BS 1363 by means of that flexible cable or cord shall be fitted with a 'standard plug' in accordance with the Plugs and Sockets etc (Safety) Regulations 1994, Statutory Instrument 1994 No. 1768, unless exempted by those regulations.</p> <p>NOTE "Standard plug" is defined in SI 1768:1994 and essentially means an approved plug conforming to BS 1363 or an approved conversion plug.</p>	Class III equipment, no such part	N/A
G.7.1	<p>Ireland</p> <p>To the first paragraph the following is added: Apparatus which is fitted with a flexible cable or cord shall be provided with a plug in accordance with Statutory Instrument 525: 1997, "13 A Plugs and Conversion Adapters for Domestic Use Regulations: 1997. S.I. 525 provides for the recognition of a standard of another Member State which is equivalent to the relevant Irish Standard</p>	Class III equipment, no such part	N/A
G.7.2	<p>Ireland and United Kingdom</p> <p>To the first paragraph the following is added: A power supply cord with a conductor of 1,25 mm² is allowed for equipment which is rated over 10 A and up to and including 13 A.</p>	Class III equipment, no such part	N/A
ZC	ANNEX ZC, NATIONAL DEVIATIONS (EN)		N/A
10.5.2	<p>Germany</p> <p>The following requirement applies: For the operation of any cathode ray tube intended for the display of visual images operating at an acceleration voltage exceeding 40 Kv, authorization is required, or application of type approval (Bauartzulassung) and marking.</p> <p><i>Justification:</i> German ministerial decree against ionizing radiation (Röntgenverordnung), in force since 2002-07-01, implementing the European Directive 96/29/EURATOM.</p> <p>NOTE Contact address: Physikalisch-Technische Bundesanstalt, Bundesallee 100, D-38116 Braunschweig, Tel.: Int +49-531-592-6320, Internet: http://www.ptb.de</p>	No cathode ray tube used	N/A



BUREAU VERITAS Test Report No: RD2009WDG0430

IEC/EN 62368-1			
Clause	Requirement + Test	Result - Remark	Verdict

4.1.2	TABLE: List of critical components					P
Object / part No.	Manufacturer/ trademark	Type / model	Technical data	Standard	Mark(s) of conformity ¹	
Input cable	Dongguan Chinglung Wire & Cable Co Ltd	21394	28AWG (for white and green), 24AWG (for red and black), 80, 30Vac, VW-1	UL 758	UL	
Or	Interchangeable	21394	28AWG (for white and green), 24AWG (for red and black), 80, 30Vac, VW-1	UL 758	UL	
-Description ²⁾ : Interchangeability based on specified rating						
Plastic enclosure material	Lotte Chemical Corporation	VH-0815(+)	V-0, 85°C, required thickness is min. 2.0mm, measured thickness is min. 2.0mm	UL 94	UL	
PCB material	Aoshikang Precision Circuit (Huizhou) Co Ltd	A-3	V-0, 130°C	UL 796	UL	
Or	Interchangeable	--	V-1 or better, min. 105°C	UL 796	UL	
-Description ²⁾ : Interchangeability based on specified rating						
Thermistor (R45)	PANASONIC	ERTJ1VR104FM	R ₂₅ = 100Kohm, R _{25/50} = 4390Kohm, NTC type	EN 62368-1	Tested with appliance	
Battery pack	Guangdong Zhaoneng Technology Co., Ltd	113450	3.7V, 2000mAh, max. charging current is 2500mA, max. discharging current is 2500mA, max. charging voltage is 4.2V	IEC 62133-2: 2017	Test report No. NTC200927 8SV00 issued by Dongguan Nore Testing Center Co., Ltd	
Lead wire of battery	Dongguan Zhongzheng Wire & Cable Tech Co Ltd	1007	24AWG, 300Vac, 80°C, VW-1	UL 758	UL	
Or	Interchangeable	--	Min. 24AWG, min. 300Vac, min. 80°C, VW-1	UL 758	UL	
-Description ²⁾ : Interchangeability based on specified rating						



IEC/EN 62368-1			
Clause	Requirement + Test	Result - Remark	Verdict

Supplementary information:

- 1) Provided evidence ensures the agreed level of compliance. See OD-CB2039.
- 2) Description line content is optional. Main line description needs to clearly detail the component used for testing

4.8.4, 4.8.5	TABLE: Lithium coin/button cell batteries mechanical tests			N/A
(The following mechanical tests are conducted in the sequence noted.)				
4.8.4.2	TABLE: Stress Relief test			—
	Part	Material	Oven Temperature (°C)	Comments
	--	--	--	--
4.8.4.3	TABLE: Battery replacement test			—
Battery part no. :		--		—
Battery Installation/withdrawal			Battery Installation/Removal Cycle	Comments
			1	--
			2	--
			3	--
			4	--
			5	--
			6	--
			8	--
			9	--
			10	--
4.8.4.4	TABLE: Drop test			—
Impact Area		Drop Distance	Drop No.	Observations
--		--	--	--
4.8.4.5	TABLE: Impact			—
Impacts per surface		Surface tested	Impact energy (Nm)	Comments
--		--	--	--
4.8.4.6	TABLE: Crush test			—
Test position		Surface tested	Crushing Force (N)	Duration force applied (s)
--		--	--	--
Supplementary information: --				



IEC/EN 62368-1			
Clause	Requirement + Test	Result - Remark	Verdict

4.8.5	TABLE: Lithium coin/button cell batteries mechanical test result			N/A
Test position	Surface tested	Force (N)	Duration force applied (s)	
--	--	--	--	

Supplementary information: --

5.2	Table: Classification of electrical energy sources	P
-----	--	---

5.2.2.2 – Steady State Voltage and Current conditions

No.	Supply Voltage	Location (e.g. circuit designation)	Test conditions	Parameters			ES Class
				U (Vrms or Vpk)	I (Apk or Arms)	Hz	
1	30Vdc	All circuits	Normal	Max. 30Vdc	--	--	ES1
			Abnormal	--	--	--	
			Single fault – SC/OC	--	--	--	

5.2.2.3 – Capacitance Limits

No.	Supply Voltage	Location (e.g. circuit designation)	Test conditions	Parameters		ES Class
				Capacitance, Nf	Upk (V)	
--	--	--	Normal	--	--	--
			Abnormal	--	--	
			Single fault – SC/OC	--	--	

5.2.2.4 – Single Pulses

No.	Supply Voltage	Location (e.g. circuit designation)	Test conditions	Parameters			ES Class
				Duration (ms)	Upk (V)	Ipk (Ma)	
--	--	--	Normal	--	--	--	--
			Abnormal	--	--	--	
			Single fault – SC/OC	--	--	--	

5.2.2.5 – Repetitive Pulses

No.	Supply Voltage	Location (e.g. circuit designation)	Test conditions	Parameters			ES Class
				Off time (ms)	Upk (V)	Ipk (Ma)	
--	--	--	Normal	--	--	--	--
			Abnormal	--	--	--	



IEC/EN 62368-1

Clause	Requirement + Test	Result - Remark	Verdict
--------	--------------------	-----------------	---------

	Single fault – SC/OC	--	--	--	
--	----------------------	----	----	----	--

Test Conditions:
 Normal –
 Abnormal –
 Supplementary information: SC=Short Circuit, OC=Short Circuit

5.4.1.4, 6.3.2, 9.0, B.2.6	TABLE: Temperature measurements							P
	Supply voltage (V)	5.0Vdc ¹⁾		6.0Vdc ²⁾		30.0Vdc ²⁾		—
	Ambient T _{min} (°C)	--	--	--	--	--	--	—
	Ambient T _{max} (°C)	--	--	--	--	--	--	—
	T _{ma} (°C)	--	--	--	--	--	--	—
Maximum measured temperature T of part/at:		T (°C)						Allowed T _{max} (°C)
Calculated value for T _{ma} :		--	45.0	--	45.0	--	45.0	--
Ambient temperature during test (T _{amb}):		26.4	--	26.5	--	27.8	--	--
1.	E-cap. C43 body	40.9	59.5	43.9	62.4	37.8	55.0	105
2.	PCB surface near U10	41.9	60.5	45.4	63.9	38.4	55.6	105
3.	PCB surface near U3	38.1	56.7	39.5	58.0	35.5	52.7	105
4.	PCB surface near PMIC U11	45.0	63.6	47.6	66.1	39.8	57.0	105
5.	PCB surface near U1	42.9	61.5	45.8	64.3	38.7	55.9	105
6.	PCB surface near U20	39.8	58.4	41.9	60.4	36.6	53.8	105
7.	PCB surface near TP14	38.8	57.4	39.7	58.2	35.9	53.1	105
8.	Plastic enclosure inside near PMIC U11	41.7	60.3	42.9	61.4	37.1	54.3	85
9.	Battery body	37.0	55.6	39.8	58.3	33.6	50.8	--
10.	Plastic enclosure inside near battery	34.8	53.4	36.1	54.6	32.3	49.5	85
11.	Plastic enclosure outside near battery	33.5	--	33.3	--	31.2	--	77
12.	Plastic enclosure outside near PMIC U11	40.5	--	40.5	--	35.8	--	77



IEC/EN 62368-1							
Clause	Requirement + Test			Result - Remark			Verdict

	Supply voltage (V)	3.7Vdc ³⁾		--	--	--	--	—
	Ambient T _{min} (°C)	--	--	--	--	--	--	—
	Ambient T _{max} (°C).....	--	--	--	--	--	--	—
	T _{ma} (°C)	--	--	--	--	--	--	—
Maximum measured temperature T of part/at:		T (°C)						Allowed T _{max} (°C)
Calculated value for T _{ma} :		--	45.0	--	--	--	--	--
Ambient temperature during test (T _{amb}):		26.8	--	--	--	--	--	--
1.	E-cap. C43 body	44.3	62.5	--	--	--	--	105
2.	PCB surface near U10	44.8	63.0	--	--	--	--	105
3.	PCB surface near U3	39.9	58.1	--	--	--	--	105
4.	PCB surface near PMIC U11	45.6	63.8	--	--	--	--	105
5.	PCB surface near U1	45.2	63.4	--	--	--	--	105
6.	PCB surface near U20	42.0	60.2	--	--	--	--	105
7.	PCB surface near TP14	40.2	58.4	--	--	--	--	105
8.	Plastic enclosure inside near PMIC U11	43.0	61.2	--	--	--	--	85
9.	Battery body	40.5	58.7	--	--	--	--	--
10.	Plastic enclosure inside near battery	36.8	55.0	--	--	--	--	85
11.	Plastic enclosure outside near battery	33.8	--	--	--	--	--	77
12.	Plastic enclosure outside near PMIC U11	40.5	--	--	--	--	--	77

Supplementary information:

- Supplied by external DC source via type C USB port, the EUT was working normally with max. power, internal fully discharged battery was charging;
- Supplied by external DC source via M8 port, the EUT was working normally with max. power, internal fully discharged battery was charging;
- Supplied by internal fully charged battery, the EUT was working normally with max. power.

Temperature T of winding:	t ₁ (°C)	R ₁ (Ω)	t ₂ (°C)	R ₂ (Ω)	T (°C)	Allowed T _{max} (°C)	Insulation class
--	--	--	--	--	--	--	--

Supplementary information:

Note 1: T_{ma} should be considered as directed by applicable requirement

Note 2: T_{ma} is not included in assessment of Touch Temperatures (Clause 9)



IEC/EN 62368-1			
Clause	Requirement + Test	Result - Remark	Verdict

5.4.1.10.2	TABLE: Vicat softening temperature of thermoplastics		N/A
Penetration (mm)		--	—
Object/ Part No./Material		Manufacturer/t rademark	T softening (°C)
--		--	--
supplementary information: --			

5.4.1.10.3	TABLE: Ball pressure test of thermoplastics			N/A
Allowed impression diameter (mm)		--		—
Object/Part No./Material	Manufacturer/trademark	Test temperature (°C)	Impression diameter (mm)	
--	--	--	--	
Supplementary information: --				

5.4.2.2, 5.4.2.4 and 5.4.3	TABLE: Minimum Clearances/Creepage distance							N/A
Clearance (cl) and creepage distance (cr) at/of/between:	Up (V)	U r.m.s. (V)	Frequency (kHz) ¹	Required cl (mm)	cl (mm) ²	Required ³ cr (mm)	cr (mm)	
--	--	--	--	--	--	--	--	
Supplementary information:								
Note 1: Only for frequency above 30 kHz								
Note 2: See table 5.4.2.4 if this is based on electric strength test								
Note 3: Provide Material Group								

5.4.2.3	TABLE: Minimum Clearances distances using required withstand voltage				N/A
Overvoltage Category (OV):				II	
Pollution Degree:				2	
Clearance distanced between:		Required withstand voltage	Required cl (mm)	Measured cl (mm)	
--		--	--	--	
Supplementary information: --					

5.4.2.4	TABLE: Clearances based on electric strength test			N/A
Test voltage applied between:		Required cl (mm)	Test voltage (Kv) peak/ r.m.s. / d.c.	Breakdown Yes / No
--		--	--	--
Supplementary information: --				



IEC/EN 62368-1			
Clause	Requirement + Test	Result - Remark	Verdict

5.4.4.2, 5.4.4.5 c) 5.4.4.9	TABLE: Distance through insulation measurements				N/A
Distance through insulation di at/of:	Peak voltage (V)	Frequency (kHz)	Material	Required DTI (mm)	DTI (mm)
--	--	--	--	--	--
Supplementary information: --					

5.4.9	TABLE: Electric strength tests			N/A
Test voltage applied between:	Voltage shape (AC, DC)	Test voltage (V)	Breakdown Yes / No	
Functional:				
--	--	--	--	
Basic/supplementary:				
--	--	--	--	
Reinforced:				
--	--	--	--	
Routine Tests:				
--	--	--	--	
Supplementary information: --				

5.5.2.2	TABLE: Stored discharge on capacitors				N/A
Supply Voltage (V), Hz	Test Location	Operating Condition (N, S)	Switch position On or off	Measured Voltage (after 2 seconds)	ES Classification
--	--	--	--	--	--
Supplementary information:					
X-capacitors installed for testing are:					
<input type="checkbox"/> bleeding resistor rating:					
<input type="checkbox"/> ICX:					
Notes:					
30. Test Location:					
Phase to Neutral; Phase to Phase; Phase to Earth; and/or Neutral to Earth					
B. Operating condition abbreviations:					
N – Normal operating condition (e.g., normal operation, or open fuse); S –Single fault condition					



IEC/EN 62368-1			
Clause	Requirement + Test	Result - Remark	Verdict

5.6.6.2	TABLE: Resistance of protective conductors and terminations				N/A
Accessible part	Test current (A)	Duration (min)	Voltage drop (V)	Resistance (Ω)	
--	--	--	--	--	

Supplementary information: --

5.7.2.2, 5.7.4	TABLE: Earthed accessible conductive part		N/A
Supply voltage	--		--
Location	Test conditions specified in 6.1 of IEC 60990 or Fault Condition No in IEC 60990 clause 6.2.2.1 through 6.2.2.8, except for 6.2.2.7		Touch current (Ma)
--	1		--
	2*		--
	3		--
	4		--
	5		--
	6		--
	8		--

Supplementary Information:

Notes:

[1] Supply voltage is the anticipated maximum Touch Voltage

[2] Earthed neutral conductor [Voltage differences less than 1% or more]

[3] Specify method used for measurement as described in IEC 60990 sub-clause 4.3

[4] IEC60990, sub-clause 6.2.2.7, Fault 7 not applicable.

[5] (*) IEC60990, sub-clause 6.2.2.2 is not applicable if switch or disconnect device (e.g., appliance coupler) provided.

6.2.2	Table: Electrical power sources (PS) measurements for classification				P
Source	Description	Measurement	Max Power after 3 s	Max Power after 5 s*)	PS Classification
External DC source	Normal	Power (W) :	--	--	PS2 (declared by manufacturer)
		V _A (V) :	--	--	
		I _A (A) :	--	--	
Battery cell	Normal	Power (W) :	27.35	27.35	PS2
		V _A (V) :	2.82	2.82	
		I _A (A) :	9.7	9.7	



IEC/EN 62368-1				
Clause	Requirement + Test		Result - Remark	Verdict

M8 port	Normal	Power (W) :	0	--	PS1
		V _A (V) :	0	--	
		I _A (A) :	0	--	
M8 port	PMIC U11 pin 1-13 shorted	Power (W) :	0	--	PS1
		V _A (V) :	0	--	
		I _A (A) :	0	--	
Type C USB port	Normal	Power (W) :	0	--	PS1
		V _A (V) :	0	--	
		I _A (A) :	0	--	
Type C USB port	PMIC U11 pin 1-13 shorted	Power (W) :	0	--	PS1
		V _A (V) :	0	--	
		I _A (A) :	0	--	

Supplementary Information:

(* Measurement taken only when limits at 3 seconds exceed PS1 limits

6.2.3.1	Table: Determination of Potential Ignition Sources (Arcing PIS)				N/A
Location	Open circuit voltage After 3 s (V _p)	Measured r.m.s current (I _{rms})	Calculated value (V _p x I _{rms})	Arcing PIS? Yes / No	
--	---	--	--	--	

Supplementary information:

An Arcing PIS requires a minimum of 50 V (peak) a.c. or d.c. An Arcing PIS is established when the product of the open circuit voltage (V_p) and normal operating condition rms current (I_{rms}) is greater than 15.

6.2.3.2	Table: Determination of Potential Ignition Sources (Resistive PIS)					P
Circuit Location (x-y)	Operating Condition (Normal / Describe Single Fault)	Measured wattage or VA During first 30 s (W / VA)	Measured wattage or VA After 30 s (W / VA)	Protective Circuit, Regulator, or PTC Operated? Yes / No (Comment)	Resistive PIS? Yes/No	
All circuits/components	--	--	--	--	Yes (declaration)	

Supplementary Information:

A combination of voltmeter, VA and ammeter IA may be used instead of a wattmeter.

If a separate voltmeter and ammeter are used, the product of (VA x IA) is used to determine Resistive PIS classification.

A Resistive PIS: (a) dissipates more than 15 W, measured after 30 s of normal operation, or (b) under single fault conditions has either a power exceeding 100 W measured immediately after the introduction of the fault if



IEC/EN 62368-1			
Clause	Requirement + Test	Result - Remark	Verdict

electronic circuits, regulators or PTC devices are used, or has an available power exceeding 15 W measured 30 s after introduction of the fault.

8.5.5	TABLE: High Pressure Lamp	N/A	
Description	Values	Energy Source Classification	
Lamp type..... :	--	—	
Manufacturer..... :	--	—	
Cat no..... :	--	—	
Pressure (cold) (Mpa)..... :	--	MS_	
Pressure (operating) (Mpa)..... :	--	MS_	
Operating time (minutes)..... :	--	—	
Explosion method..... :	--	—	
Max particle length escaping enclosure (mm)..... :	--	MS_	
Max particle length beyond 1 m (mm)..... :	--	MS_	
Overall result..... :	--		
Supplementary information: --			

B.2.5	TABLE: Input test							P
U (V)	I (mA)	I rated (mA)	P (W)	P rated (W)	Fuse No	I fuse (A)	Condition/status	
Supplied by external DC source via type C USB port, the EUT was working normally with max. power, internal fully discharged battery was charging ¹⁾								
5.0Vdc	1010	2000	5.05	--	--	--	For version 1.0 sample	
5.0Vdc	1011	2000	5.06	--	--	--	For version 1.1 sample	
Supplied by external DC source via M8 port, the EUT was working normally with max. power, internal fully discharged battery was charging ²⁾								
6.0 Vdc	960	2000	5.76	--	--	--	For version 1.0 sample	
30.0 Vdc	160	2000	4.80	--	--	--		
6.0 Vdc	962	2000	5.77	--	--	--	For version 1.1 sample	
30.0 Vdc	161	2000	4.83	--	--	--		
Supplied by internal fully charged battery, the EUT was working normally with max. power								
3.7Vdc	175	--	0.648	--	--	--	For version 1.0 sample	
3.7Vdc	175	--	0.648	--	--	--	For version 1.1 sample	
Supplementary information:								
1) The battery charging current is: max. 0.906A for version 1.0 and version 1.1 sample;								



IEC/EN 62368-1			
Clause	Requirement + Test	Result - Remark	Verdict

1) The battery charging current is:
max. 0.907A for version 1.0 and version 1.1 sample.

B.3	TABLE: Abnormal operating condition tests							N/A
Ambient temperature (°C).....							25.0°C, if not separately specified	—
Power source for EUT: Manufacturer, model/type, output rating ..							--	—
Component No.	Abnormal Condition	Supply voltage, (V)	Test time (ms)	Fuse no.	Fuse current, (A)	T-couple	Temp. (°C)	Observation
--	--	--	--	--	--	--	--	--
Supplementary information: Test table is provided to record abnormal and fault conditions for all applicable energy sources including Thermal burn injury. Column "Abnormal/Fault." Specify if test condition by indicating "Abnormal" then the condition for a Clause B.3 test or "Single Fault" then the condition for Clause B.4.								

B.4	TABLE: Fault condition tests							P
Ambient temperature (°C).....							25.0°C, if not separately specified	—
Power source for EUT: Manufacturer, model/type, output rating ..							--	—
Component No.	Fault Condition	Supply voltage, (V)	Test time (ms)	Fuse no.	Fuse current, (A)	T-couple	Temp. (°C)	Observation
Supplied by external DC source via type C USB port:								
Battery P- to B-	Shorted	5.0 Vdc	30 mins	--	--	--	--	The EUT was working normally, battery charging current was max. 0.909A, no damaged, no hazards.
PMIC U11 pin 1-13 shorted	Shorted	5.0Vdc	4 hours 15 mins	--	--	Type K	Battery body: 38.7, Enclosure outside near battery: 34.7, Ambient: 25.5	The EUT was working normally, battery charging current was max. 1.24A, no damaged, no hazards.
C2	Shorted	5.0Vdc	30 mins	--	--	--	--	The unit was shut down immediately, battery charging current was max. 0.152A, no damaged, no hazards.



IEC/EN 62368-1

Clause	Requirement + Test							Result - Remark	Verdict
R45 (NTC)	Shorted	5.0Vdc	30 mins	--	--	--	--	The unit was shut down immediately, battery charging current was 0A, no damaged, no hazards.	
R45 (NTC)	Opened	5.0Vdc	30 mins	--	--	--	--	The unit was shut down immediately, battery charging current was 0A, no damaged, no hazards.	
Supplied by external DC source via M8 port:									
Battery P- to B-	Shorted	30.0Vdc	30 mins	--	--	--	--	The EUT was working normally, battery charging current was max. 0.909A, no damaged, no hazards.	
PMIC U11 pin 1-13 shorted	Shorted	30.0Vdc	1 hour 02 mins	--	--	Type K	Battery body: 61.1, Enclosure outside near battery: 47.9, Ambient: 26.2	The EUT was working normally, battery charging current was max. 2.35A, no damaged, no hazards.	
C2	Shorted	30.0Vdc	30 mins	--	--	--	--	The unit was shut down immediately, battery charging current was max. 0.152A, no damaged, no hazards.	
R45 (NTC)	Shorted	30.0Vdc	30 mins	--	--	--	--	The unit was shut down immediately, battery charging current was 0A, no damaged, no hazards.	
R45 (NTC)	Opened	30.0Vdc	30 mins	--	--	--	--	The unit was shut down immediately, battery charging current was 0A, no damaged, no hazards.	
Supplied by internal fully charged battery:									
Battery P- to B-	Shorted	3.7Vdc	2 hours 33 mins	--	--	Type K	Battery body: 41.0, Enclosure outside near battery: 37.2, Ambient: 26.7	The unit was working normally, battery discharging current was max. 0.177A, No damaged, no hazards.	



IEC/EN 62368-1									
Clause	Requirement + Test						Result - Remark	Verdict	
C6	Shorted	3.7Vdc	30 mins	--	--	--	--	The unit was shut down immediately, battery charging current was 0A, no damaged, no hazards.	
Supplementary information:									

Annex M	TABLE: Batteries								P
The tests of Annex M are applicable only when appropriate battery data is not available									P
Is it possible to install the battery in a reverse polarity position?								No	N/A
	Non-rechargeable batteries			Rechargeable batteries					
	Discharging		Un-intentional charging	Charging		Discharging		Reversed charging	
	Meas. current	Manuf. Specs.		Meas. current	Manuf. Specs.	Meas. current	Manuf. Specs.	Meas. current	Manuf. Specs.
Max. current during normal condition	--	--	--	0.907A	2.5A	0.175A	2.5A	--	--
Max. current during fault condition (PMIC U11 pin 1-13 shorted)	--	--	--	2.35A	2.5A	--	--	--	--
Max. current during fault condition (Battery P- to B-shorted)	--	--	--	--	--	0.177A	2.5	--	--
Test results:									Verdict
- Chemical leaks						No chemical leaks.			P
- Explosion of the battery						No explosion.			P
- Emission of flame or expulsion of molten metal						No emission of flame or expulsion of molten metal			P
- Electric strength tests of equipment after completion of tests						No isolation requirement.			N/A
Supplementary information: --									

Annex M.4	Table: Additional safeguards for equipment containing secondary lithium batteries							P
Battery/Cell No.	Test conditions		Measurements				Observation	



IEC/EN 62368-1			
Clause	Requirement + Test	Result - Remark	Verdict

		U	I (mA)	Temp (°C)	
Battery	Normal	4.16V	Max. 0.907A	39.8 ¹⁾	Charging normally
Battery	PMIC U11 pin 1-13 shorted	4.16V	Max. 2.35A	61.1 ²⁾	Charging normally

Supplementary Information:

- 1) The room ambient air temperature was 26.5°C.
- 2) The room ambient air temperature was 26.2°C.

Battery identification	Charging at T _{lowest} (°C)	Observation	Charging at T _{highest} (°C)	Observation
Internal lithium battery	0°C	Charging current is limited to the value specified	≥50°C	The battery stop be charged

Supplementary Information:

The lowest specified charging temperature is 0°C, the highest specified charging temperature is 50°C

Annex Q.1	TABLE: Circuits intended for interconnection with building wiring (LPS)	N/A
------------------	--	-----

Note: Measured UOC (V) with all load circuits disconnected:

Output Circuit	Components	U _{oc} (V)	I _{sc} (A)		S (VA)	
			Meas.	Limit	Meas.	Limit
--	--	--	--	≤ 8	--	≤ 100

Supplementary Information:

SC=Short circuit, OC=Open circuit

T.2, T.3, T.4, T.5	TABLE: Steady force test	P
---------------------------	---------------------------------	----------

Part/Location	Material	Thickness (mm)	Force (N)	Test Duration (sec)	Observation
External enclosure (front)	Plastic	Min. 2.0	100	5	No damaged, no hazards
External enclosure (top)	Plastic	Min. 2.0	100	5	No damaged, no hazards
External enclosure (rear)	Plastic	Min. 2.0	100	5	No damaged, no hazards

Supplementary information: --



IEC/EN 62368-1			
Clause	Requirement + Test	Result - Remark	Verdict

T.6, T.9	TABLE: Impact tests			N/A
Part/Location	Material	Thickness (mm)	Vertical distance (mm)	Observation
--	--	--	--	--
Supplementary information: --				

T.7	TABLE: Drop tests				P
Part/Location	Material	Thickness (mm)	Drop Height (mm)	Observation	
External enclosure (front)	Plastic	Min. 2.0	1000	No damaged, no hazards	
External enclosure (bottom)	Plastic	Min. 2.0	1000	No damaged, no hazards	
External enclosure (rear)	Plastic	Min. 2.0	1000	No damaged, no hazards	
Supplementary information: --					

T.8	TABLE: Stress relief test					P
Part/Location	Material	Thickness (mm)	Oven Temperature (°C)	Duration (h)	Observation	
External enclosure	Plastic	Min. 2.0	72	7	No damaged, No hazards	
Supplementary information: --						



Photos



General view - 1



General view - 2



General view - 3



Internal view - 1

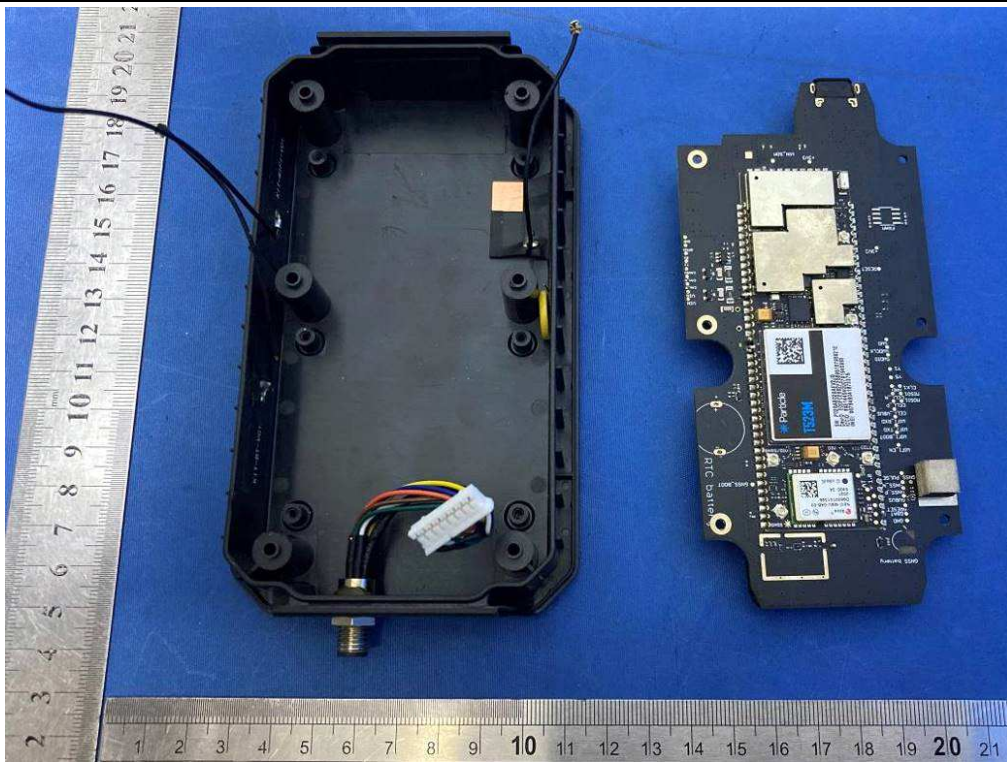

Internal view – 2

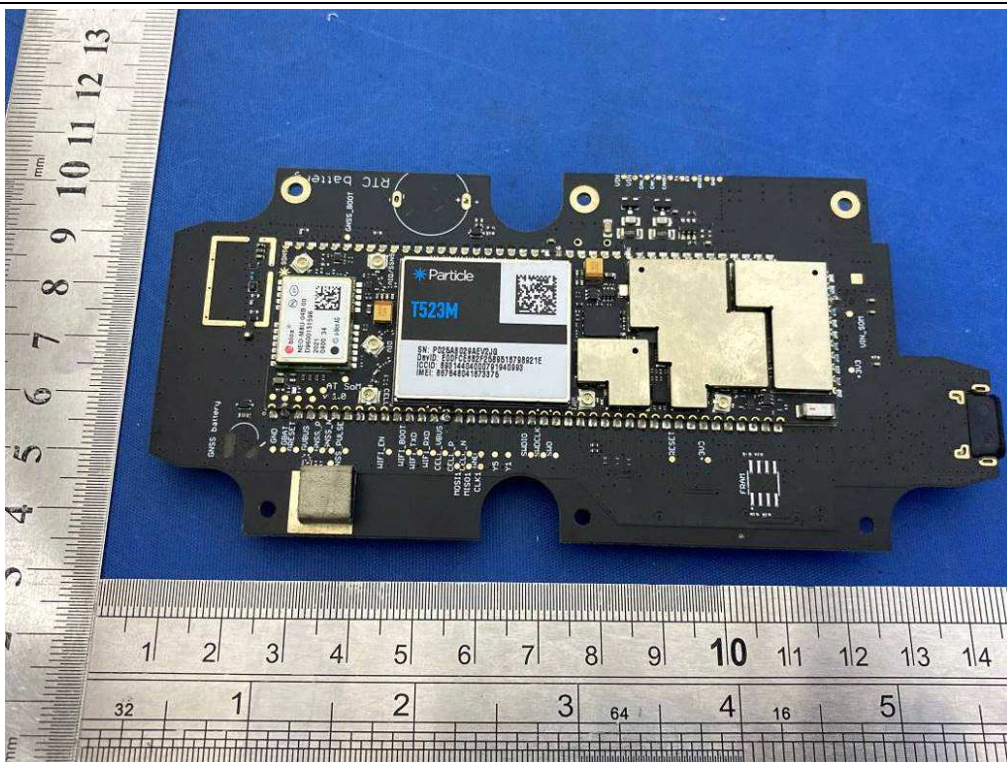

Main board view – 1

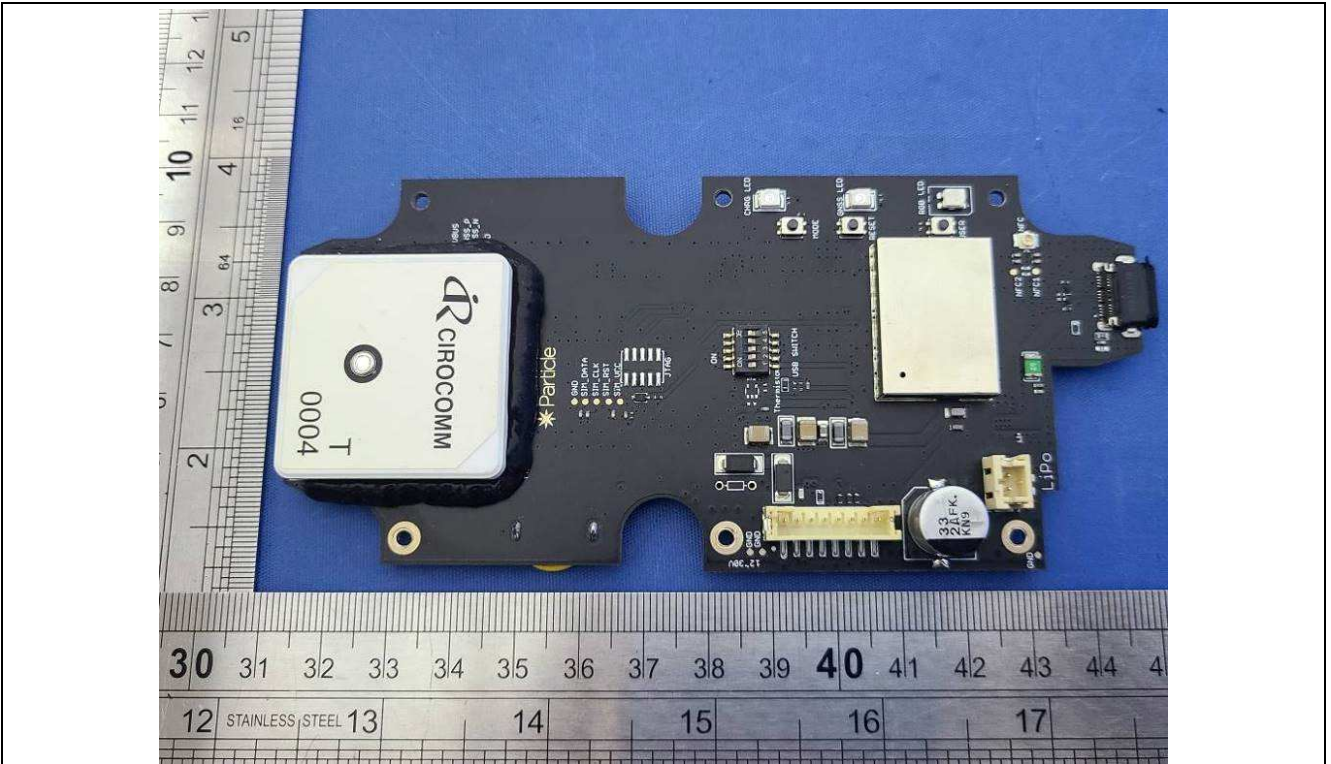

Main board view – 2 of Version 1.0 sample

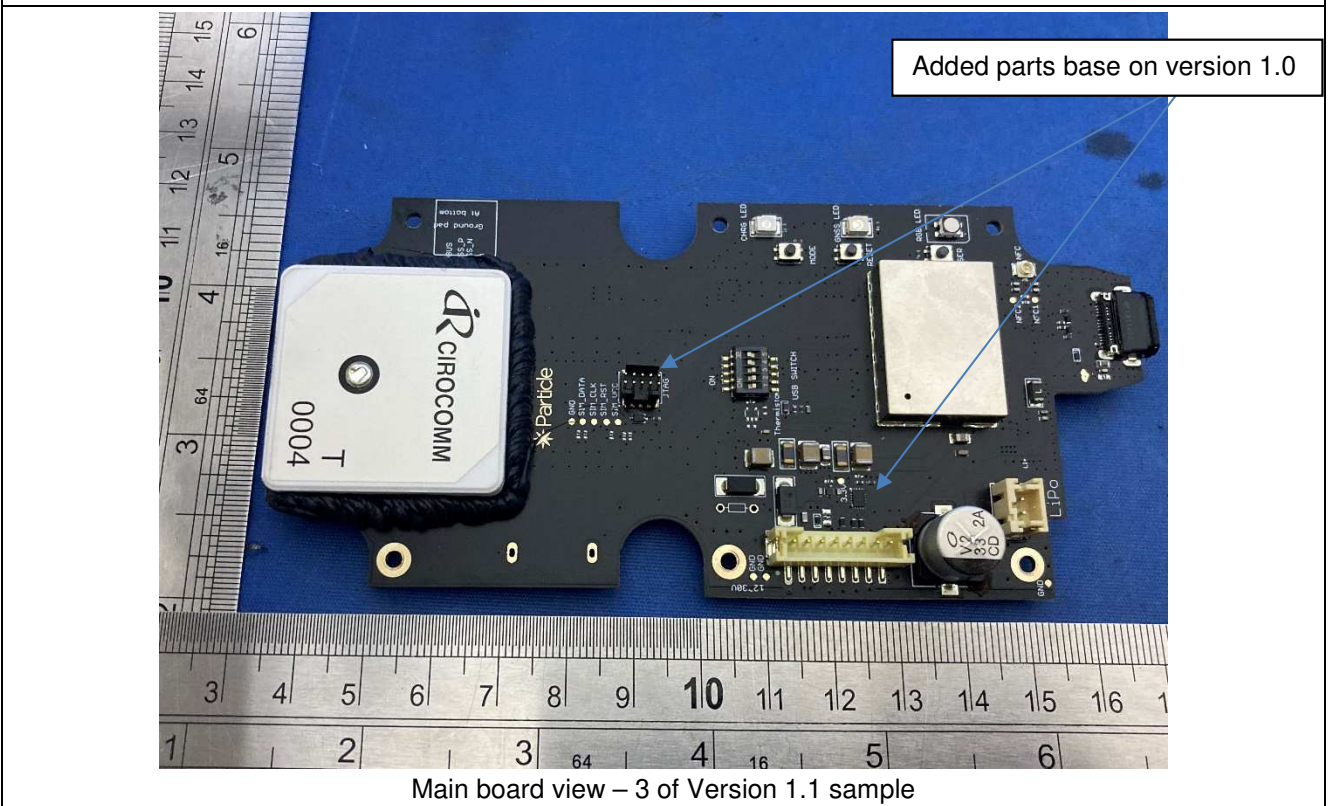

Main board view – 3 of Version 1.1 sample

