



BUREAU VERITAS

Test Report No.: RE2107WDG0228



TEST REPORT

Applicant	Particle Industries, Inc
Address	126 Post St, 4th floor, San Francisco, CA 94108 USA

Manufacturer or Supplier	Particle Industries, Inc	
Address	126 Post St, 4th floor, San Francisco, CA 94108 USA	
Product	Argon	
Brand Name	Particle Industries, Inc	
Model	ARGN	
Additional Model & Model Difference	N/A	
Date of tests	Aug. 17, 2018 ~ Oct. 26, 2018 Jun. 15, 2021 ~ Aug. 09, 2021	

The submitted sample of the above equipment has been tested according to the requirements of the following standards:

EN 300 328 V2.2.2 (2019-07)

CONCLUSION: The submitted sample was found to COMPLY with the test requirement

Tested by Andy Zhu Supervisor / EMC Department	Approved by Glyn He Assistant Manager / EMC Department
	Date: Aug. 16, 2021

This report is governed by, and incorporates by reference, CPS Conditions of Service as posted at the date of issuance of this report at <https://www.cps.bureauveritas.com/terms-conditions> and is intended for your exclusive use. Any copying or replication of this report to or for any other person or entity, or use of our name or trademark, is permitted only with our prior written permission. This report sets forth our findings solely with respect to the test samples identified herein. The results set forth in this report are not indicative or representative of the quality or characteristics of the lot from which a test sample was taken or any similar or identical product unless specifically and expressly noted. Our report includes all of the tests requested by you and the results thereof based upon the information that you provided to us. Measurement uncertainty is only provided upon request for accredited tests. You have 60 days from date of issuance of this report to notify us of any material error or omission caused by our negligence or if you require measurement uncertainty; provided, however, that such notice shall be in writing and shall specifically address the issue you wish to raise. A failure to raise such issue within the prescribed time shall constitute your unqualified acceptance of the completeness of this report, the tests conducted and the correctness of the report contents.



TABLE OF CONTENTS

RELEASE CONTROL RECORD 4

1. SUMMARY OF TEST RESULTS 5

1.1. TEST INSTRUMENTS 6

1.2. MEASUREMENT UNCERTAINTY 8

1.3. MAXIMUM MEASUREMENT UNCERTAINTY 8

2. GENERAL INFORMATION..... 9

2.1. GENERAL DESCRIPTION OF EUT 9

2.2. DESCRIPTION OF TEST MODES..... 10

2.2.1. TEST MODE APPLICABILITY AND TESTED CHANNEL DETAIL.....11

2.3. GENERAL DESCRIPTION OF APPLIED STANDARDS 15

2.4. DESCRIPTION OF SUPPORT UNITS 15

3 TEST PROCEDURES AND RESULTS 16

TRANSMITTER PARAMETERS 16

3.1. RF OUTPUT POWER 16

3.1.1. LIMITS OF RF OUTPUT POWER 16

3.1.2. TEST PROCEDURE..... 16

3.1.3. DEVIATION FROM TEST STANDARD 16

3.1.4. TEST SETUP 16

3.1.5. TEST RESULTS 17

3.2. POWER SPECTRAL DENSITY 18

3.2.1. LIMIT OF POWER SPECTRAL DENSITY 18

3.2.2. TEST PROCEDURE..... 18

3.2.3. DEVIATION FROM TEST STANDARD 18

3.2.4. TEST SETUP 18

3.2.5. TEST RESULTS 19

3.3. OCCUPIED CHANNEL BANDWIDTH 20

3.3.1. LIMIT OF OCCUPIED CHANNEL BANDWIDTH..... 20

3.3.2. TEST PROCEDURE..... 20

3.3.3. DEVIATION FROM TEST STANDARD 20

3.3.4. TEST SETUP 20

3.3.5. TEST RESULTS 21

3.4. TRANSMITTER UNWANTED EMISSIONS IN THE OUT-OF-BAND DOMAIN 22

3.4.1. LIMITS OF TRANSMITTER UNWANTED EMISSIONS IN THE OUT-OF-BAND DOMAIN..... 22

3.4.2. TEST PROCEDURE..... 22

3.4.3. DEVIATION FROM TEST STANDARD 22

3.4.4. TEST SETUP 23

3.4.5. TEST RESULTS 23

3.5. ADAPTIVE (CHANNEL ACCESS MECHANISM)..... 25

3.5.1. APPLICABILITY OF ADAPTIVE REQUIREMENTS AND LIMIT FOR WIDE BAND MODULATION TECHNIQUES..... 25

3.5.2. TEST PROCEDURES 26

3.5.3. TEST SETUP CONFIGURATION..... 26

3.5.4. INTERFERENCE THRESHOLD LEVEL 26

3.5.5. LIST OF MEASUREMENTS..... 27

3.5.6. TEST RESULT 28

3.5.6.1. ADAPTIVE RESULT 28

3.5.6.2. THE CHANNEL OCCUPANCY TIME RESULT 33



3.6.	TRANSMITTER SPURIOUS EMISSIONS	37
3.6.1.	LIMITS OF TRANSMITTER SPURIOUS EMISSIONS.....	37
3.6.2.	TEST PROCEDURE.....	37
3.6.3.	DEVIATION FROM TEST STANDARD	38
3.6.4.	TEST SETUP.....	38
3.6.5.	TEST RESULTS	39
	RECEIVER PARAMETERS	43
3.7.	RECEIVER SPURIOUS RADIATION.....	43
3.7.1.	LIMITS OF RECEIVER SPURIOUS RADIATION	43
3.7.2.	TEST PROCEDURE.....	43
3.7.3.	DEVIATION FROM TEST STANDARD	43
3.7.4.	TEST SETUP.....	43
3.7.5.	TEST RESULTS	44
3.8.	RECEIVER BLOCKING	47
3.8.1.	LIMITS OF RECEIVER BLOCKING	47
3.8.2.	TEST PROCEDURE.....	48
3.8.3.	DEVIATION FROM TEST STANDARD	48
3.8.4.	TEST SETUP CONFIGURATION.....	49
3.8.5.	TEST RESULT	50
4	PHOTOGRAPHS OF THE TEST CONFIGURATION	51
5	APPENDIX A – MODIFICATIONS RECORDERS FOR ENGINEERING CHANGES TO THE EUT BY THE LAB.....	53



RELEASE CONTROL RECORD

ISSUE NO.	REASON FOR CHANGE	DATE ISSUED
RE180817N043-2	Original release	Nov. 30, 2018
RE2107WDG0228	Basic the above original report to updated: 1) Reduced IEEE802.15.4 functions; 2) Renew standard. Need to retest the below items after evaluation: 1) Receiver Spurious Emissions (below 1GHz); 2) Receiver Blocking.	Aug. 16, 2021



1. SUMMARY OF TEST RESULTS

The EUT has been tested according to the following specifications:

EN 300 328 V2.2.2		
Clause	Test Parameter	Results
	TRANSMITTER PARAMETERS	
4.3.2.2	RF Output Power	Pass
4.3.2.3	Power Spectral Density	Pass
4.3.2.6	Adaptivity	Pass
4.3.2.7	Occupied Channel Bandwidth	Pass
4.3.2.8	Transmitter unwanted emission in the OOB domain	Pass
4.3.2.9	Transmitter unwanted emissions in the spurious domain	Pass
4.3.2.12	Geo-location capability	Not Applicable
	RECEIVER PARAMETERS	
4.3.2.10	Receiver Spurious Emissions	Pass
4.3.2.11	Receiver Blocking	Pass



1.1. TEST INSTRUMENTS

Equipment	Manufacturer	Model No.	Serial No.	Next Cal.
EMI Test Receiver	Rohde&Schwarz	ESU40	100449	Mar. 07,22
Signal and Spectrum Analyzer	Rohde&Schwarz	FSV40	101094	Feb. 24,22
Bilog Antenna	Teseq	CBL 6111D	30643	May 29,22
Horn Antenna	ETS-Lindgren	3117	00062558	May 29,22
GPS Generator+ Antenna	TOJOIN	GNSS-5000A	E1-010119	N/A
3m Semi-anechoic Chamber	ETS-LINDGREN	9m*6m*6m	NSEMC003	May 22,22
Test Software	ADT	ADT_Radiated_V7.6.15.9.2	N/A	N/A
Horn Antenna (15GHz-40GHz)	SCHWARZBECK	BBHA 9170	BBHA9170147	May 09, 22
Amplifier	Burgeon	BPA-530	100220	Mar. 13,22
Broadband Preamplifier (1GHz~18GHz)	SCHWARZBECK	BBV9718	305	May 08,22
Pre-Amplifier (18GHz-40GHz)	EMCI	EMC 184045	980102	Mar. 13,22
Power Sensor	Keysight	U2021XA	MY55060016	N/A
Power Sensor	Keysight	U2021XA	MY55060018	May 09, 22
Digital Multimeter	FLUKE	15B	A1220009DG	Aug. 05,22
Humid & Temp Programmable Tester	Haida	HD-2257	110807201	Nov. 03,21
Oscilloscope	Agilent	DSO9254A	MY51260160	Aug. 10,21
Signal and Spectrum Analyzer	Rohde&Schwarz	FSV7	102331	May 09, 22
Spectrum Analyzer	Keysight	N9020A	MY55400499	Feb. 24,22
Signal Generator	Agilent	N5183A	MY50140980	Aug. 10,21
MXG-B RF Vector Signal Generator	Keysight	N5182B	MY56200288	Sep. 04,21
Wireless Connectivity Tester	Rohde&Schwarz	CMW270	100908	Sep. 26,21
Vector Signal Generator	Rohde&Schwarz	SMBV100A	257579	Sep. 04,21
Attenuator	MINI	BW-S10W2+	S130129FGE2	N/A

NOTES:

1. The test was performed in 966 Chamber and RF Oven room.
2. The calibration interval of the above test instruments is 12 months and the calibrations are traceable to CEPREI/CHINA, GRGT/CHINA and NIM/CHINA.
3. The horn antenna is used only for the measurement of emission frequency above 1GHz if tested.



For Receiver Blocking test and Adaptivity test:

Equipment	Manufacturer	Model No.	Serial No.	Next Cal.
Wireless Connectivity Tester	Rohde&Schwarz	CMW270	100908	Sep. 26,21
Signal Analyzer	Rohde&Schwarz	FSV7	102331	May 09, 22
Spectrum Analyzer	Keysight	N9020A	MY55400499	Feb. 24,22
Signal Generator	Agilent	N5183A	MY50140980	Aug. 10,21
MXG-B RF Vector Signal Generator	Keysight	N5182B	MY56200288	Sep. 04,21
Power Sensor	Keysight	U2021XA	MY55060016	N/A
Power Sensor	Keysight	U2021XA	MY55060018	May 09, 22
Vector Signal Generator	Rohde&Schwarz	SMBV100A	257579	Sep. 04,21
Agile Signal Generator	Agilent	8645A	Agilent	N/A
Shield Box	TOJOIN	MS4345-C	SZA18A 3038	N/A
Attenuator	TOJOIN	CHB-8-90-1-B 50SMA	0803002	N/A
COM Power Splitter	TOJOIN	PS-TX-2B	020801	N/A
COM Power Splitter	TOJOIN	PS-TX-2B	020802	N/A
Test software	TonScend	JS1120-3-1	JS-001	N/A

NOTES:

1. The test was performed in RF Oven room.
2. The calibration interval of the above test instruments is 12 months and the calibrations are traceable to CEPREI/CHINA, GRGT/CHINA and NIM/CHINA.



1.2. MEASUREMENT UNCERTAINTY

Where relevant, the following measurement uncertainty levels have been estimated for tests performed on the EUT:

This uncertainty represents an expanded uncertainty expressed at approximately the 95% confidence level using a coverage factor of k=2.

Parameter	Uncertainty
Occupied Channel Bandwidth	±1.132 %
RF output power, conducted	±0.56dB
Power Spectral Density, conducted	±1.017dB
Unwanted Emissions, conducted	±1.017dB
All emissions, radiated	±4.84dB
Temperature	±0.23°C
Supply voltages	±0.1 %
Time	±4 %

1.3. MAXIMUM MEASUREMENT UNCERTAINTY

For the test methods, according to ETSI EN 300 328 standard, the measurement uncertainty figures shall be calculated in accordance with ETR 100 028-1 [4] and shall correspond to an expansion factor (coverage factor) k = 1,96 or k = 2 (which provide confidence levels of respectively 95 % and 95,45 % in the case where the distributions characterizing the actual measurement uncertainties are normal (Gaussian)).

Maximum measurement uncertainty

Parameter	Uncertainty
Occupied Channel Bandwidth	±5 %
RF output power, conducted	±1,5 dB
Power Spectral Density, conducted	±3 dB
Unwanted Emissions, conducted	±3 dB
All emissions, radiated	±6 dB
Temperature	±3 °C
Supply voltages	±3 %
Time	±5 %



2. GENERAL INFORMATION

2.1. GENERAL DESCRIPTION OF EUT

PRODUCT	Argon
TEST MODEL	ARGN
ADDITIONAL MODELS	N/A
NOMINAL VOLTAGE	Li+ PIN /Battery connector: DC 3.7V from Li-ion Battery or VUSB PIN /USB connector :DC 5V from USB Host Unit
OPERATING TEMPERATURE RANGE	-20 ~ +75°C
MODULATION TECHNOLOGY	DSSS, OFDM
MODULATION TYPE	CCK, DQPSK, DBPSK for DSSS 64QAM, 16QAM, QPSK, BPSK for OFDM
OPERATING FREQUENCY	2412-2472MHz for 11b/g/n(HT20) 2422-2462MHz for 11n(HT40)
ADPTIVE/NON-ADPTIVE	<input type="checkbox"/> non-adaptive Equipment <input checked="" type="checkbox"/> adaptive Equipment without the possibility to switch to a non-adaptive mode <input type="checkbox"/> adaptive Equipment which can also operate in a non-adaptive mode
EIRP (MAX.)	18.05dBm (Measured Max.)
ANTENNA TYPE	FPCB Antenna, 2dBi Gain
CABLE SUPPLIED	N/A

Notes:

1. The above EUT information is declared by manufacturer and for more detailed features description, please refer to the manufacturer's specifications or user's manual.
2. For the test results, the EUT had been tested with all conditions, but only the worst case was shown in test report.
3. Please refer to the EUT photo document (Reference No.: 180817N043) for detailed product photo.
4. The EUT is wireless module, it no any accessories.
5. The EUT have SISO function, provides 1 completed transmitters and 1 receivers.

MODULATION MODE	TX FUNCTION
802.11b	1TX/1RX
802.11g	1TX/1RX
802.11n (HT20)	1TX/1RX
802.11n (HT40)	1TX/1RX



2.2. DESCRIPTION OF TEST MODES

13 channels are provided for 802.11b, 802.11g and 802.11n (HT20):

CHANNEL	FREQUENCY	CHANNEL	FREQUENCY
1	2412 MHz	8	2447 MHz
2	2417 MHz	9	2452 MHz
3	2422 MHz	10	2457 MHz
4	2427 MHz	11	2462 MHz
5	2432 MHz	12	2467 MHz
6	2437 MHz	13	2472 MHz
7	2442 MHz		

9 channels are provided for 802.11n (HT40):

CHANNEL	FREQUENCY	CHANNEL	FREQUENCY
3	2422 MHz	8	2447 MHz
4	2427 MHz	9	2452 MHz
5	2432 MHz	10	2457 MHz
6	2437 MHz	11	2462 MHz
7	2442 MHz		



2.2.1. TEST MODE APPLICABILITY AND TESTED CHANNEL DETAIL

EUT CONFIGURE MODE	APPLICABLE TO								DESCRIPTION
	ROP	PSD	AD	OCB	OOB	RSE<1G	RSE≥1G	RB	
A	√	√	-	√	√	√	√	√	Powered by Fully Battery
B	-	-	-	-	-	-	-	-	Powered by Adapter

Where **ROP**: RF Output Power **PSD**: Power Spectral Density
AD: Adaptivity (Channel Access Mechanism) **OCB**: Occupied Channel Bandwidth
OOB: Transmitter unwanted emission in the out-of-band domain **RSE<1G**: Spurious Emissions below 1GHz
RSE≥1G: Spurious Emissions above 1GHz **RB**: Receiver Blocking

RF OUTPUT POWER TEST:

- Pre-Scan has been conducted to determine the worst-case mode from all possible combinations between available modulations, data rates and antenna ports (if EUT with antenna diversity architecture).
- Following channel(s) was (were) selected for the final test as listed below.

MODE	AVAILABLE CHANNEL	TESTED CHANNEL	MODULATION TECHNOLOGY	MODULATION TYPE	DATA RATE (Mbps)
802.11b	1 to 13	1, 7, 13	DSSS	DBPSK	1.0
802.11g	1 to 13	1, 7, 13	OFDM	BPSK	6.0
802.11n (HT20)	1 to 13	1, 7, 13	OFDM	BPSK	6.5
802.11n (HT40)	3 to 11	3, 7, 11	OFDM	BPSK	13.5

POWER SPECTRAL DENSITY TEST:

- Pre-Scan has been conducted to determine the worst-case mode from all possible combinations between available modulations, data rates and antenna ports (if EUT with antenna diversity architecture).
- Following channel(s) was (were) selected for the final test as listed below.

MODE	AVAILABLE CHANNEL	TESTED CHANNEL	MODULATION TECHNOLOGY	MODULATION TYPE	DATA RATE (Mbps)
802.11b	1 to 13	1, 7, 13	DSSS	DBPSK	1.0
802.11g	1 to 13	1, 7, 13	OFDM	BPSK	6.0
802.11n (HT20)	1 to 13	1, 7, 13	OFDM	BPSK	6.5
802.11n (HT40)	3 to 11	3, 7, 11	OFDM	BPSK	13.5



ADAPTIVITY TEST:

Following channel(s) was (were) selected for the final test as listed below.

MODE	AVAILABLE CHANNEL	TESTED CHANNEL	MODULATION TECHNOLOGY
802.11b	1 to 13	1, 13	DSSS
802.11g	1 to 13	1, 13	OFDM
802.11n (HT20)	1 to 13	1, 13	OFDM
802.11n (HT40)	3 to 11	3, 11	OFDM

OCCUPIED CHANNEL BANDWIDTH TEST:

Pre-Scan has been conducted to determine the worst-case mode from all possible combinations between available modulations, data rates and antenna ports (if EUT with antenna diversity architecture).

Following channel(s) was (were) selected for the final test as listed below.

MODE	AVAILABLE CHANNEL	TESTED CHANNEL	MODULATION TECHNOLOGY	MODULATION TYPE	DATA RATE (Mbps)
802.11b	1 to 13	1, 13	DSSS	DBPSK	1.0
802.11g	1 to 13	1, 13	OFDM	BPSK	6.0
802.11n (HT20)	1 to 13	1, 13	OFDM	BPSK	6.5
802.11n (HT40)	3 to 11	3, 11	OFDM	BPSK	13.5

TRANSMITTER UNWANTED EMISSION IN THE OUT-OF-BAND DOMAIN TEST:

Pre-Scan has been conducted to determine the worst-case mode from all possible combinations between available modulations, data rates and antenna ports (if EUT with antenna diversity architecture).

Following channel(s) was (were) selected for the final test as listed below.

MODE	AVAILABLE CHANNEL	TESTED CHANNEL	MODULATION TECHNOLOGY	MODULATION TYPE	DATA RATE (Mbps)
802.11b	1 to 13	1, 13	DSSS	DBPSK	1.0
802.11g	1 to 13	1, 13	OFDM	BPSK	6.0
802.11n (HT20)	1 to 13	1, 13	OFDM	BPSK	6.5
802.11n (HT40)	3 to 11	3, 11	OFDM	BPSK	13.5



SPURIOUS EMISSIONS TEST (BELOW 1 GHz):

- Pre-Scan has been conducted to determine the worst-case mode from all possible combinations between available modulations, data rates and antenna ports (if EUT with antenna diversity architecture).
- Following channel(s) was (were) selected for the final test as listed below.

MODE	AVAILABLE CHANNEL	TESTED CHANNEL	MODULATION TECHNOLOGY	MODULATION TYPE	DATA RATE (Mbps)
802.11b	1 to 13	1	DSSS	DBPSK	1
Receiver	1 to 13	1	-	-	-

SPURIOUS EMISSIONS TEST (ABOVE 1 GHz):

- Pre-Scan has been conducted to determine the worst-case mode from all possible combinations between available modulations, data rates and antenna ports (if EUT with antenna diversity architecture).
- Following channel(s) was (were) selected for the final test as listed below.

MODE	AVAILABLE CHANNEL	TESTED CHANNEL	MODULATION TECHNOLOGY	MODULATION TYPE	DATA RATE (Mbps)
802.11b	1 to 13	1, 13	DSSS	DBPSK	1.0
802.11g	1 to 13	1, 13	OFDM	BPSK	6.0
802.11n (HT20)	1 to 13	1, 13	OFDM	BPSK	6.5
802.11n (HT40)	3 to 11	3, 11	OFDM	BPSK	13.5
Receiver	1 to 13	1, 13	-	-	-

RECEIVER BLOCKING TEST:

- Following channel(s) was (were) selected for the final test as listed below.

MODE	AVAILABLE CHANNEL	TESTED CHANNEL	MODULATION TECHNOLOGY	MODULATION TYPE	DATA RATE (Mbps)
802.11b	1 to 13	1, 13	DSSS	DBPSK	1.0



TEST CONDITION:

APPLICABLE TO	ENVIRONMENTAL CONDITIONS	INPUT POWER	TESTED BY
ROP	25deg. C, 60%RH	DC 3.7V from Fully Battery	Vincent
PSD	25deg. C, 60%RH	DC 3.7V from Fully Battery	Vincent
AD	25deg. C, 60%RH	DC 3.7V from Fully Battery	Vincent
OCB	25deg. C, 60%RH	DC 3.7V from Fully Battery	Vincent
OOB	25deg. C, 60%RH	DC 3.7V from Fully Battery	Vincent
RSE<1G	25deg. C, 55%RH	DC 3.7V from Fully Battery	Eric
RSE≥1G	25deg. C, 55%RH	DC 3.7V from Fully Battery	Eric
RB	25deg. C, 60%RH	DC 3.7V from Fully Battery	Vincent



2.3. GENERAL DESCRIPTION OF APPLIED STANDARDS

The EUT is a RF product, according to the specifications of the manufacturers. It must comply with the requirements of the following standards:

EN 300 328 V2.2.2 (2019-07)

All test items have been performed and recorded as per the above standards.

2.4. DESCRIPTION OF SUPPORT UNITS

The EUT has been tested as an independent unit together with other necessary accessories or support units. The following support units or accessories were used to form a representative test configuration during the tests.

NO.	PRODUCT	BRAND	MODEL NO.	SERIAL NO.	FCC ID
1	DC source	LONG WEI	PS-6403D	010934269	N/A

NO.	SIGNAL CABLE DESCRIPTION OF THE ABOVE SUPPORT UNITS
1	AC Line: Unshielded, Detachable 1.5m, DC Line: Unshielded, Detachable 1.0m



3 TEST PROCEDURES AND RESULTS

TRANSMITTER PARAMETERS

3.1. RF OUTPUT POWER

3.1.1. LIMITS OF RF OUTPUT POWER

CONDITION	FREQUENCY BAND	LIMIT (e.i.r.p.)
Under all test conditions	2400 ~ 2483.5 MHz	AV: 20dBm

3.1.2. TEST PROCEDURE

Refer to chapter 5.4.2.2 of ETSI EN 300 328 V2.2.2.

Measurement	
<input checked="" type="checkbox"/> Conducted measurement	<input type="checkbox"/> Radiated measurement

3.1.3. DEVIATION FROM TEST STANDARD

No deviation.

3.1.4. TEST SETUP

The measurement was performed at both normal environmental conditions and at the extremes of the operating temperature. The measurement was performed at the lowest, the middle, and the highest channel. The equipment was configured to operate under its worst case situation with respect to output power. (In case of conducted measurements the transmitter shall be connected to the measuring equipment via a suitable attenuator.) Controlling software has been activated to set the EUT on specific channel and power level.



3.1.5. TEST RESULTS

TEST CONDITION			EIRP POWER (dBm)		
			(CH1) 2412 MHz	(CH7) 2442 MHz	(CH13) 2472 MHz
802.11b					
T _{nom} (°C)	+25	V _{nom} (V)	17.69	16.72	16.24
T _{min} (°C)	-20		18.05	16.89	16.58
T _{max} (°C)	+75		17.39	16.35	15.75
802.11g					
T _{nom} (°C)	+25	V _{nom} (V)	15.75	15.49	14.95
T _{min} (°C)	-20		15.86	15.83	15.25
T _{max} (°C)	+75		15.59	14.94	14.43
802.11n (HT20)					
T _{nom} (°C)	+25	V _{nom} (V)	15.72	15.31	15.04
T _{min} (°C)	-20		15.73	15.58	15.38
T _{max} (°C)	+75		15.20	14.80	14.34
TEST CONDITION			EIRP POWER (dBm)		
			(CH3) 2422 MHz	(CH7) 2442 MHz	(CH11) 2462 MHz
802.11n (HT40)					
T _{nom} (°C)	+25	V _{nom} (V)	15.67	15.36	15.24
T _{min} (°C)	-20		15.90	15.60	15.48
T _{max} (°C)	+75		15.09	14.91	15.02

NOTE: EIRP = Conducted output power + ANT Gain.



3.2. POWER SPECTRAL DENSITY

3.2.1. LIMIT OF POWER SPECTRAL DENSITY

CONDITION	FREQUENCY BAND	LIMIT (e.i.r.p.)
Under normal conditions	2400 ~ 2483.5 MHz	10dBm / 1MHz

3.2.2. TEST PROCEDURE

Refer to chapter 5.4.3.2 of ETSI EN 300 328 V2.2.2.

Measurement Method	
<input checked="" type="checkbox"/> Conducted measurement	<input type="checkbox"/> Radiated measurement
<input checked="" type="checkbox"/> Option 1: For equipment with continuous and non-continuous transmissions	
<input type="checkbox"/> Option 2: For equipment with continuous transmission capability or for equipment operating (or with the capability to operate) with a constant duty cycle (e.g. Frame Based equipment)	

3.2.3. DEVIATION FROM TEST STANDARD

No deviation.

3.2.4. TEST SETUP

The measurement was performed at normal environmental conditions only. The measurement was performed at the lowest, the middle, and the highest channel. The equipment was configured to operate under its worst case situation with respect to output power. (In case of conducted measurements the transmitter shall be connected to the measuring equipment via a suitable attenuator.) Controlling software has been activated to set the EUT on specific status.



3.2.5. TEST RESULTS

802.11b

CHANNEL	CHANNEL FREQUENCY (MHz)	POWER DENSITY (dBm/1MHz) (E.I.R.P)	LIMIT (dBm/1MHz) (E.I.R.P)	PASS/FAIL
1	2412.00	8.75	10	PASS
7	2442.00	7.77	10	PASS
13	2472.00	7.28	10	PASS

802.11g

CHANNEL	CHANNEL FREQUENCY (MHz)	POWER DENSITY (dBm/1MHz) (E.I.R.P)	LIMIT (dBm/1MHz) (E.I.R.P)	PASS/FAIL
1	2412.00	4.18	10	PASS
7	2442.00	3.94	10	PASS
13	2472.00	3.42	10	PASS

802.11n (HT20)

CHANNEL	CHANNEL FREQUENCY (MHz)	POWER DENSITY (dBm/1MHz) (E.I.R.P)	LIMIT (dBm/1MHz) (E.I.R.P)	PASS/FAIL
1	2412.00	7.49	10	PASS
7	2442.00	7.96	10	PASS
13	2472.00	7.75	10	PASS

802.11n (HT40)

CHANNEL	CHANNEL FREQUENCY (MHz)	POWER DENSITY (dBm/1MHz) (E.I.R.P)	LIMIT (dBm/1MHz) (E.I.R.P)	PASS/FAIL
3	2422.00	0.70	10	PASS
7	2442.00	0.49	10	PASS
11	2462.00	0.42	10	PASS



3.3. OCCUPIED CHANNEL BANDWIDTH

3.3.1. LIMIT OF OCCUPIED CHANNEL BANDWIDTH

CONDITION		LIMIT
All types of equipment		Shall fall completely within the band 2400 to 2483.5 MHz.
Additional requirement	For non-adaptive using wide band modulations other than FHSS system and e.i.r.p >10dBm.	Less than 20MHz
	For non-adaptive Frequency Hopping system and e.i.r.p >10dBm.	Less than 5MHz

3.3.2. TEST PROCEDURE

Refer to chapter 5.4.7.2 of ETSI EN 300 328 V2.2.2.

Measurement	
<input checked="" type="checkbox"/> Conducted measurement	<input type="checkbox"/> Radiated measurement

3.3.3. DEVIATION FROM TEST STANDARD

No deviation.

3.3.4. TEST SETUP

The measurement was performed at normal environmental conditions only. This measurement was performed at the lowest and the highest channel. The equipment was configured to operate under its worst case situation with respect to output power. (In case of conducted measurements the transmitter shall be connected to the measuring equipment via a suitable attenuator.) Controlling software has been activated to set the EUT on specific status.



3.3.5. TEST RESULTS

802.11b

CHANNEL	CHANNEL FREQUENCY (MHz)	OCCUPIED BANDWIDTH (MHz)	Measured frequencies		LIMIT	PASS/FAIL
			FL (MHz)	FH (MHz)		
1	2412	13.28	2405.36	2418.64	FL > 2400 MHz and FH < 2483.5 MHz	PASS
13	2472	13.28	2465.36	2478.64		PASS

802.11g

CHANNEL	CHANNEL FREQUENCY (MHz)	OCCUPIED BANDWIDTH (MHz)	Measured frequencies		LIMIT	PASS/FAIL
			FL (MHz)	FH (MHz)		
1	2412	17.12	2403.44	2420.56	FL > 2400 MHz and FH < 2483.5 MHz	PASS
13	2472	17.04	2463.44	2480.48		PASS

802.11n(HT20)

CHANNEL	CHANNEL FREQUENCY (MHz)	OCCUPIED BANDWIDTH (MHz)	Measured frequencies		LIMIT	PASS/FAIL
			FL (MHz)	FH (MHz)		
1	2412	17.92	2403.04	2420.96	FL > 2400 MHz and FH < 2483.5 MHz	PASS
13	2472	17.92	2463.04	2480.96		PASS

802.11n(HT40)

CHANNEL	CHANNEL FREQUENCY (MHz)	OCCUPIED BANDWIDTH (MHz)	Measured frequencies		LIMIT	PASS/FAIL
			FL (MHz)	FH (MHz)		
3	2422	36.48	2403.76	2440.24	FL > 2400 MHz and FH < 2483.5 MHz	PASS
11	2462	36.48	2443.76	2480.24		PASS

Note: FL is the lowest frequency of the 99% occupied bandwidth of power envelope.
FH is the highest frequency of the 99% occupied bandwidth of power envelope.



3.4. TRANSMITTER UNWANTED EMISSIONS IN THE OUT-OF-BAND DOMAIN

3.4.1. LIMITS OF TRANSMITTER UNWANTED EMISSIONS IN THE OUT-OF-BAND DOMAIN

CONDITION	LIMIT
Under all test conditions	The transmitter unwanted emissions in the out-of-band domain but outside the allocated band, shall not exceed the values provided by the mask in below figure.

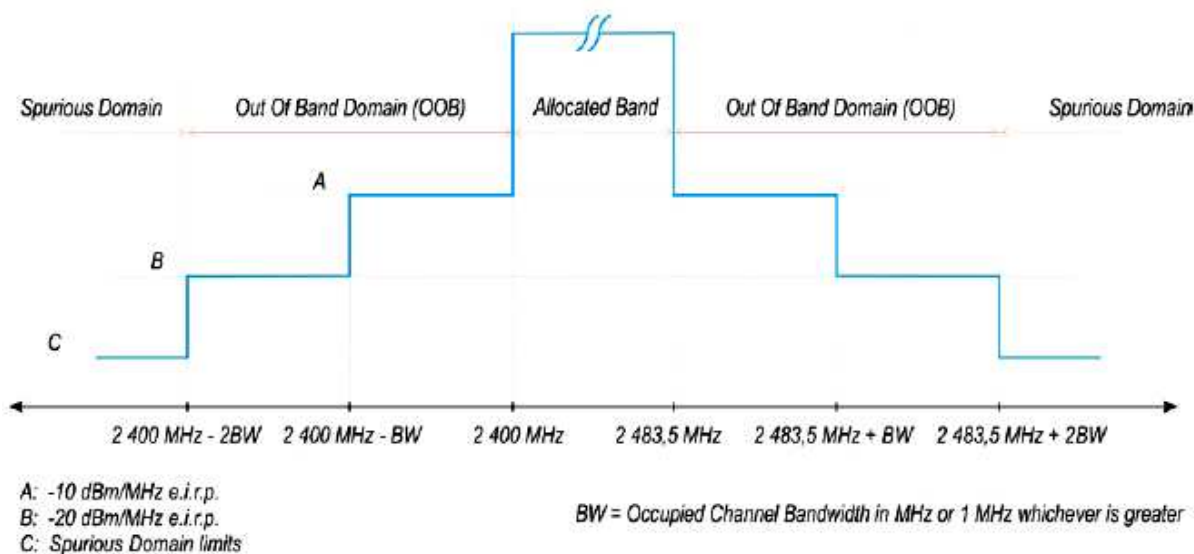

3.4.2. TEST PROCEDURE

Refer to chapter 5.4.8.2 of ETSI EN 300 328 V2.2.2.

Measurement	
<input checked="" type="checkbox"/> Conducted measurement	<input type="checkbox"/> Radiated measurement

3.4.3. DEVIATION FROM TEST STANDARD

No deviation.



3.4.4. TEST SETUP

The measurement was performed at normal environmental conditions only. This measurement was performed at the lowest and the highest channel. The equipment was configured to operate under its worst case situation with respect to output power. (In case of conducted measurements the transmitter shall be connected to the measuring equipment via a suitable attenuator.) The frequency has to be recorded for the right and left end above threshold of highest and lowest channel respectively.

3.4.5. TEST RESULTS

802.11b

CHANNEL FREQ.(MHz)			2412				2472			
TEST CONDITION			OOB Emission (MHz)				OOB Emission (MHz)			
			2386.72 ~ 2400		2373.44 ~ 2386.72		2483.5 ~ 2496.78		2496.78 ~ 2510.06	
Temperature	Voltage		Freq. (MHz)	Power (dBm)	Freq. (MHz)	Power (dBm)	Freq. (MHz)	Power (dBm)	Freq. (MHz)	Power (dBm)
Tnorm(°C)	25	Normal	2399.50	-44.01	2386.22	-52.66	2484.00	-41.27	2497.28	-53.78
Limit (dBm/MHz)			-10.00		-20.00		-10.00		-20.00	
PASS/FAIL			PASS		PASS		PASS		PASS	

802.11g

CHANNEL FREQ.(MHz)			2412				2472			
TEST CONDITION			OOB Emission (MHz)				OOB Emission (MHz)			
			2382.88 ~ 2400		2365.76 ~ 2382.88		2483.5 ~ 2500.54		2500.54 ~ 2517.58	
Temperature	Voltage		Freq. (MHz)	Power (dBm)	Freq. (MHz)	Power (dBm)	Freq. (MHz)	Power (dBm)	Freq. (MHz)	Power (dBm)
Tnorm(°C)	25	Normal	2399.50	-32.95	2382.38	-47.80	2484.00	-31.85	2501.12	-48.31
Limit (dBm/MHz)			-10.00		-20.00		-10.00		-20.00	
PASS/FAIL			PASS		PASS		PASS		PASS	



802.11n (HT20)

CHANNEL FREQ.(MHz)			2412				2472			
TEST CONDITION			OOB Emission (MHz)				OOB Emission (MHz)			
			2382.08 ~ 2400		2364.16 ~ 2382.08		2483.5 ~ 2501.42		2501.42 ~ 2519.34	
Temperature	Voltage		Freq. (MHz)	Power (dBm)	Freq. (MHz)	Power (dBm)	Freq. (MHz)	Power (dBm)	Freq. (MHz)	Power (dBm)
Tnorm(°C)	25	Normal	2399.50	-33.98	2381.58	-48.50	2484.00	-31.58	2501.92	-49.27
Limit (dBm/MHz)			-10.00		-20.00		-10.00		-20.00	
PASS/FAIL			PASS		PASS		PASS		PASS	

802.11n (HT40)

CHANNEL FREQ.(MHz)			2422				2462			
TEST CONDITION			OOB Emission (MHz)				OOB Emission (MHz)			
			2363.52 ~ 2400		2327.04 ~ 2363.52		2483.5 ~ 2519.98		2519.98 ~ 2556.46	
Temperature	Voltage		Freq. (MHz)	Power (dBm)	Freq. (MHz)	Power (dBm)	Freq. (MHz)	Power (dBm)	Freq. (MHz)	Power (dBm)
Tnorm(°C)	25	Normal	2399.50	-29.13	2363.02	-48.44	2484.00	-29.81	2520.48	-49.94
Limit (dBm/MHz)			-10.00		-20.00		-10.00		-20.00	
PASS/FAIL			PASS		PASS		PASS		PASS	



3.5. ADAPTIVE (CHANNEL ACCESS MECHANISM)

3.5.1. APPLICABILITY OF ADAPTIVE REQUIREMENTS AND LIMIT FOR WIDE BAND MODULATION TECHNIQUES

Requirement	Operational Mode			
	Non-LBT based Detect and Avoid	LBT based Detect and Avoid		
		Frame Based Equipment	Load Based Equipment (CCA using 'energy detect')	Load Based Equipment (CCA not using any of the mechanisms referenced as note 2)
Minimum Clear Channel Assessment (CCA) Time	NA	18 us (see note 1)	(see note 2)	18 us (see note 1)
Maximum Channel Occupancy (COT) Time	40 ms	1 ms to 10 ms	(see note 2)	13 ms
Minimum Idle Period	5us	5% of COT	(see note 2)	18us (see note 3)
Extended CCA check	NA	NA	(see note 2)	18us~160us
Short Control Signalling Transmissions	Maximum duty cycle of 10 % within an observation period of 50 ms (see note 4)			

NOTE 1: The CCA time used by the equipment shall be declared by the supplier.
 NOTE 2: Load Based Equipment may implement an LBT based spectrum sharing mechanism based on the Clear Channel Assessment (CCA) mode using energy detect, as described in IEEE 802.11™-2012 clause 9, clause 10, clause 16, clause 17, clause 19 and clause 20, or in IEEE 802.15.4™-2011 [i.4], clause 4, clause 5 and clause 8
 NOTE 3: The Idle Period in between transmissions is considered to be the CCA or the Extended CCA check as there are no transmissions during this period.
 NOTE 4: Adaptive equipment may or may not have Short Control Signalling Transmissions

Interference threshold level

Maximum transmit power (P _H) EIRP dBm	Threshold level (TL) (see notes 1 and 2)
20	-70 dBm / MHz

NOTE 1: For a 20 dBm e.i.r.p. transmitter the CCA threshold level (TL) shall be equal to or less than -70 dBm/MHz at the input to the receiver assuming a 0 dBi (receive) antenna assembly. This threshold level (TL) may be corrected for the (receive) antenna assembly gain (G)
 NOTE 2: For power levels less than 20 dBm e.i.r.p. the CCA threshold level may be relaxed to:
 $TL = -70 \text{ dBm/MHz} + 10 \times \log_{10} (100 \text{ mW} / P_{out})$; (P_{out} in mW e.i.r.p.)

Wanted signal mean power from companion device	Unwanted signal frequency (MHz)	Unwanted signal power (dBm)
sufficient to maintain the link (see note 2)	2 395 or 2 488,5 (see note 1)	-35 (see note 3)

NOTE 1: The highest frequency shall be used for testing operating channels within the range 2 400 MHz to 2 442 MHz, while the lowest frequency shall be used for testing operating channels within the range 2 442 MHz to 2 483,5 MHz. See clause 5.4.6.1.
 NOTE 2: A typical value which can be used in most cases is -50 dBm/MHz.
 NOTE 3: The level specified is the level in front of the UUT antenna. In case of conducted measurements, this level has to be corrected by the actual antenna assembly gain.



3.5.2. TEST PROCEDURES

Refer to chapter 5.4.6.2 of ETSI EN 300 328 V2.2.2.

Measurement	
<input checked="" type="checkbox"/> Conducted measurement	<input type="checkbox"/> Radiated measurement

3.5.3. TEST SETUP CONFIGURATION

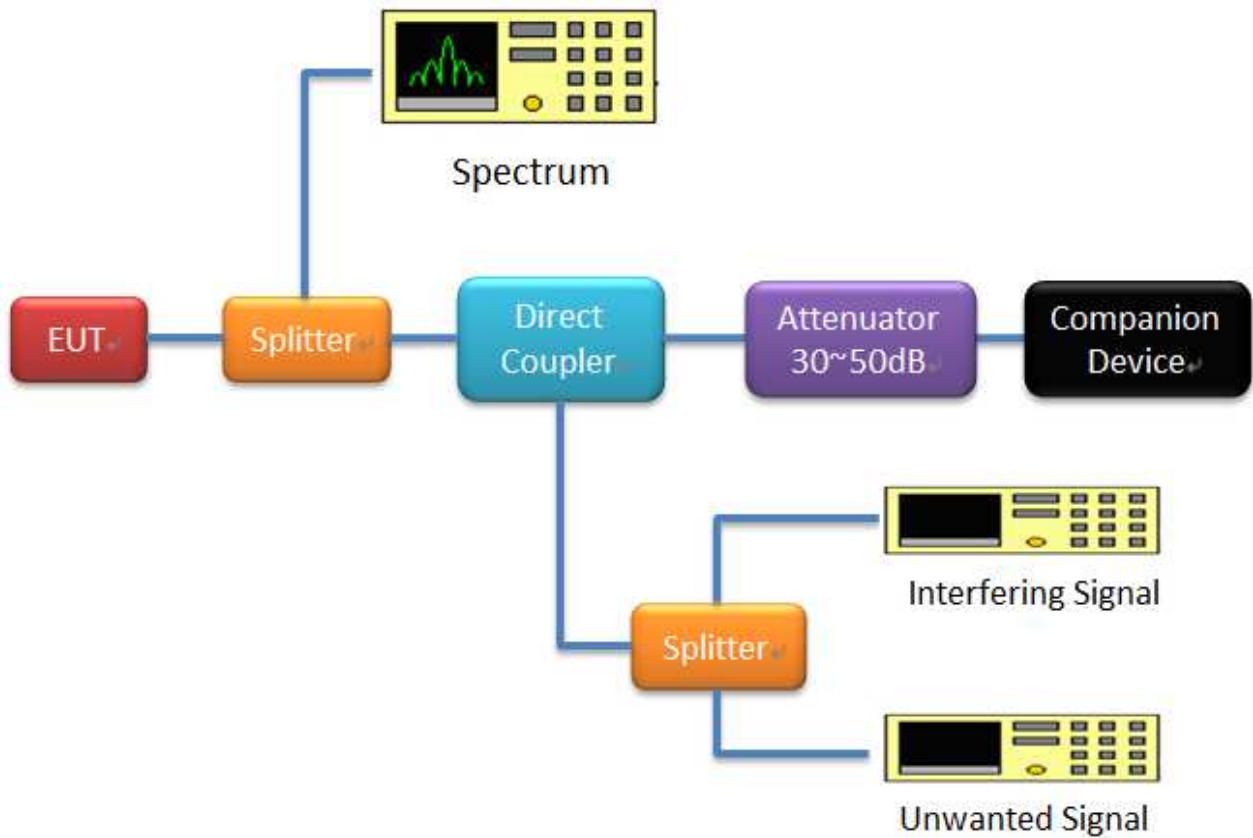

3.5.4. INTERFERENCE THRESHOLD LEVEL

Detection Threshold Level
The maximum EIRP power is 18.05dBm and antenna gain is 2dBi. Detection Threshold level= $-70 \text{ dBm/MHz} + 10 \times \log_{10} (100 \text{ mW} / (18.05\text{dBm})) + 2 = -66.05\text{dBm/MHz}$, The interference signal level to the UUT is -66.05dBm/MHz



3.5.5. LIST OF MEASUREMENTS

UUT Operational Mode	Applicable	Limit	
		The Maximum Channel Occupancy Time	The Minimum idle Period
Frame Based Equipment		meet in 1ms ~ 10ms	>5% x channel occupancy time
Load Based Equipment (Base on 'Spectrum Sharing' mechanisms)		Follow IEEE 802.11 Less than _____ms	Follow IEEE 802.11 More than _____ms
Load Based Equipment (Not using any of the mechanisms referenced)	v	13ms	18us

Clause	Test Parameter	Remarks	Pass/Fail
4.3.2.6.3.2.2	Adaptive (Frame Based Equipment)	Not Applicable	NA
4.3.2.6.3.2.3	Adaptive (Load Based Equipment)	Applicable	Pass
4.3.2.6.4	Short Control Signalling Transmissions	Applicable	Pass



3.5.6. TEST RESULT

3.5.6.1. ADAPTIVE RESULT

OPERATING FREQUENCY BANDS AND MODE OF EUT

Operational Mode	Operating Frequency - Low Channel (MHz)	Operating Frequency -High Channel (MHz)	Test Result
802.11b	2412	2472	PASS
802.11g	2412	2472	PASS
802.11n (HT20)	2412	2472	PASS
802.11n (HT40)	2422	2462	PASS



**BUREAU
VERITAS**

Test Report No.: RE2107WDG0228

802.11b

2412MHz

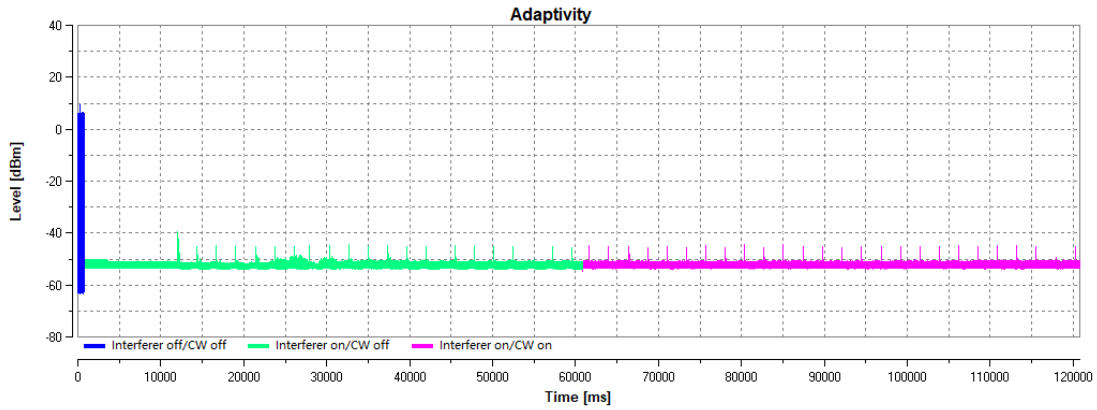

2472MHz

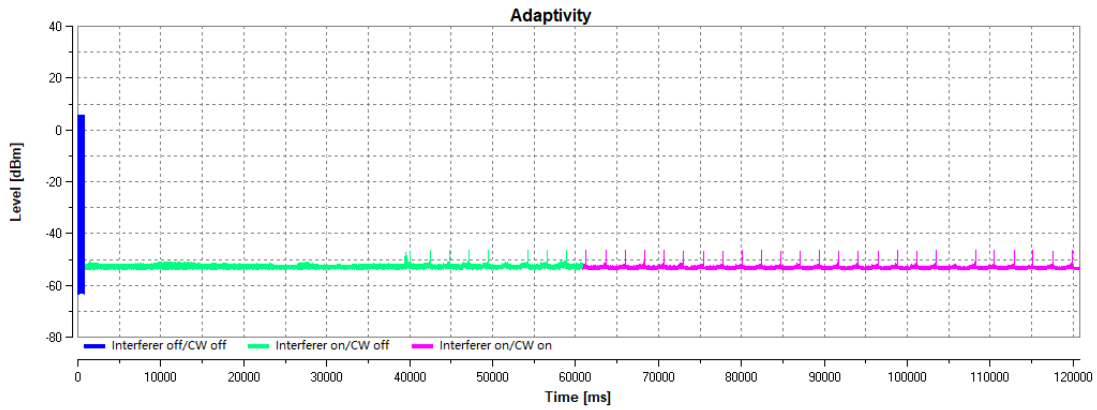

Max. TxOn: 1.10 ms; Duty cycle: 2.2%

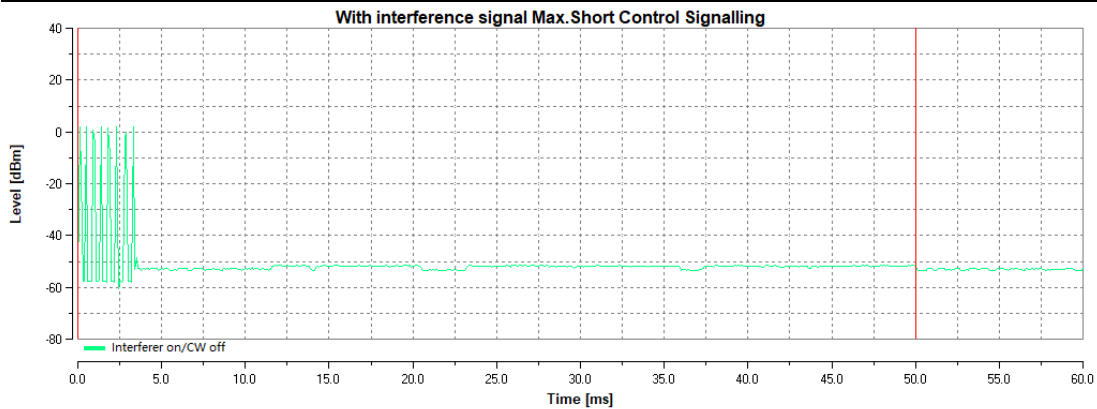



BUREAU VERITAS

Test Report No.: RE2107WDG0228

802.11g

2412MHz

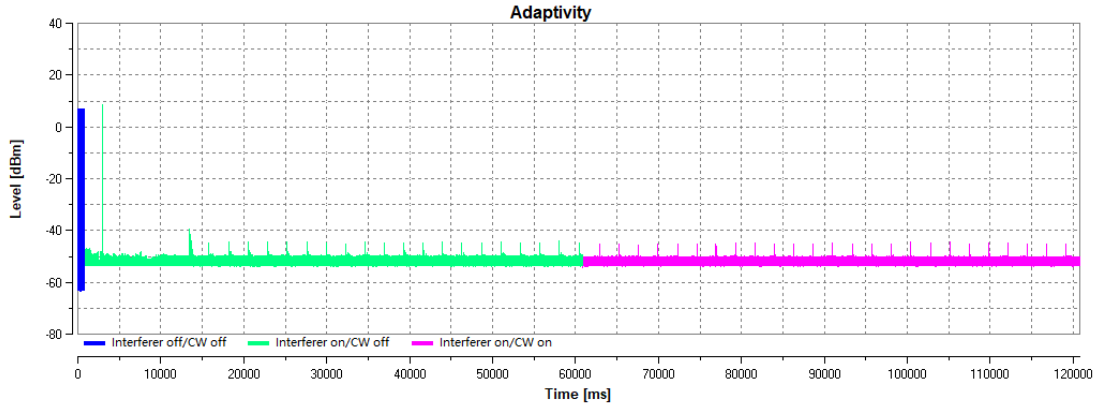

2472MHz

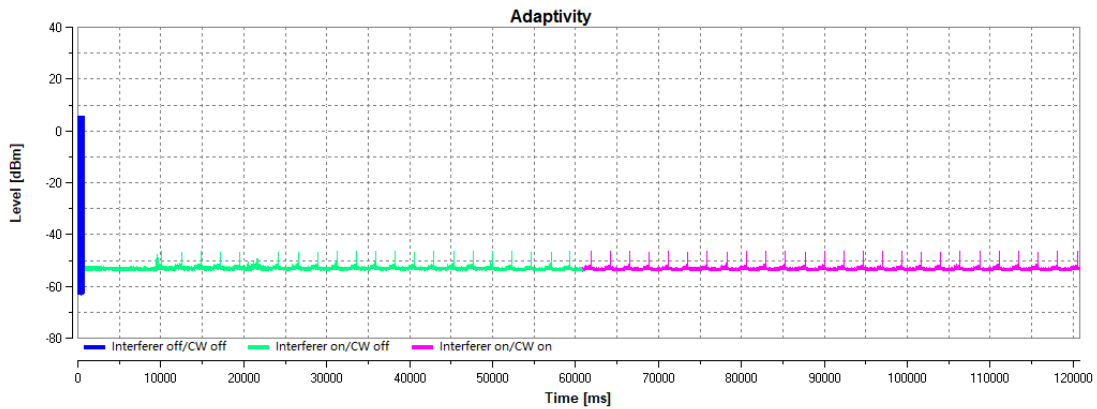

Max. TxOn: 1.20ms; Duty cycle: 2.4%

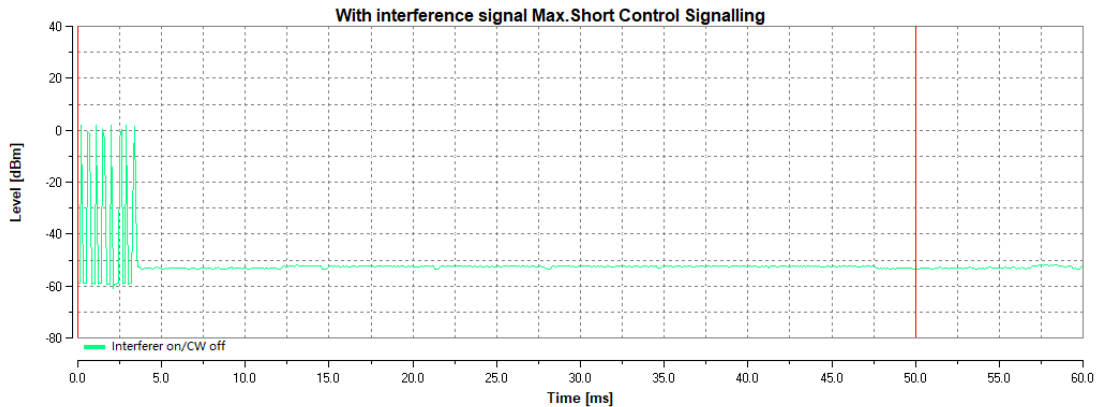



802.11n(HT20)

2412MHz

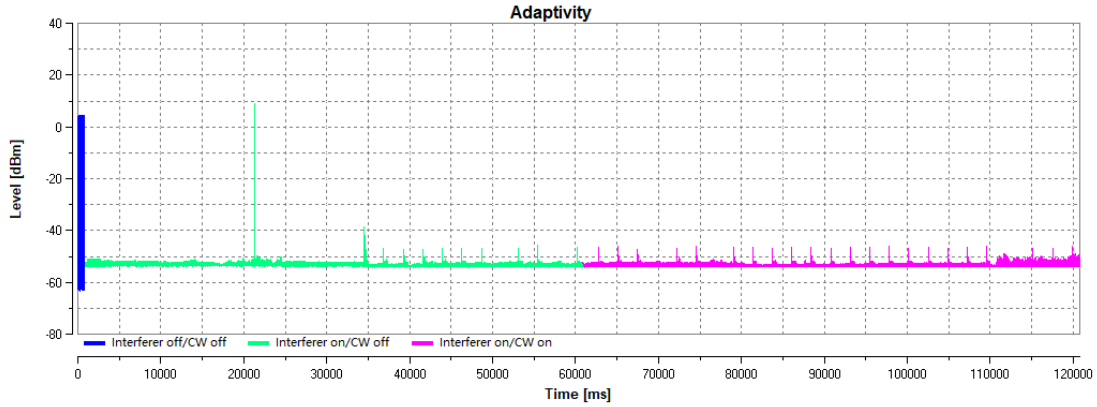

2472MHz

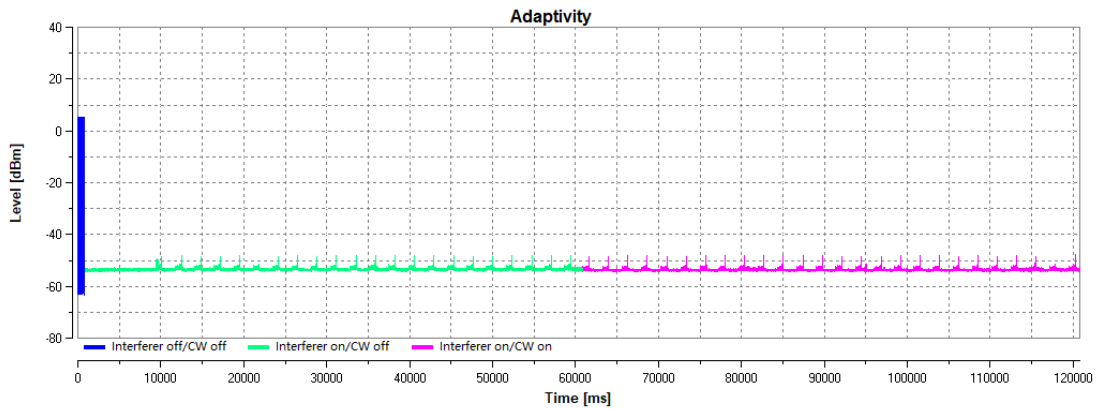

Max. TxOn: 0.00ms; Duty cycle: 0%

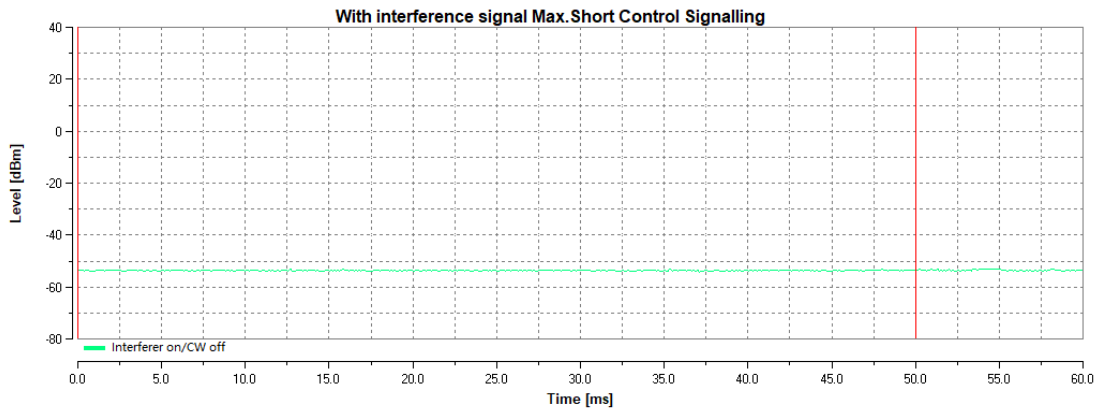



802.11n(HT40)

2422MHz

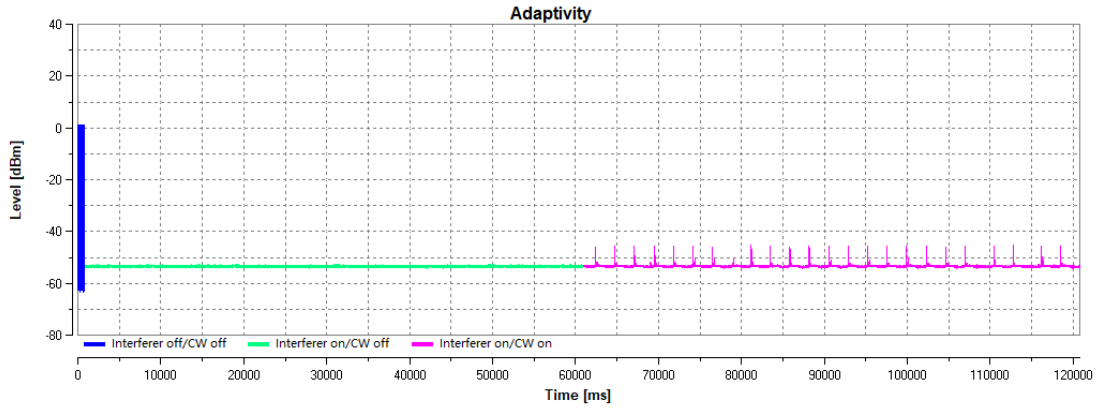

2462MHz

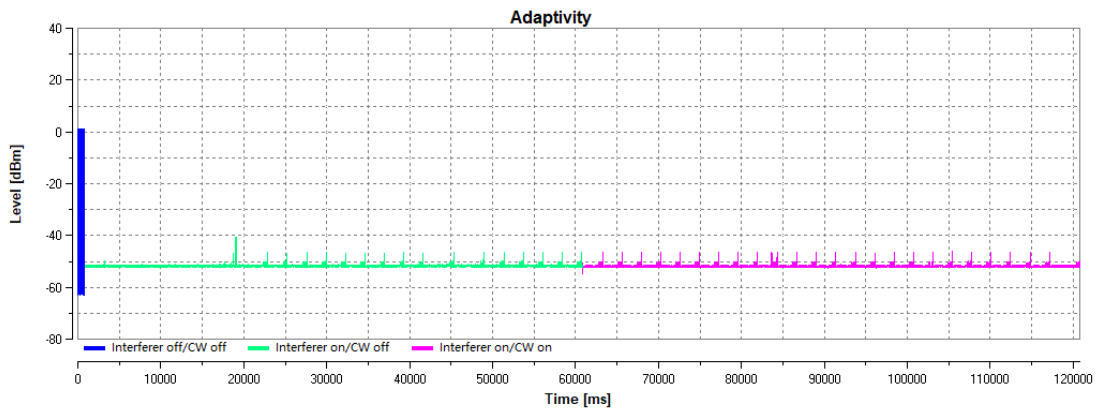

Max. TxOn: 0.50ms; Duty cycle: 1%

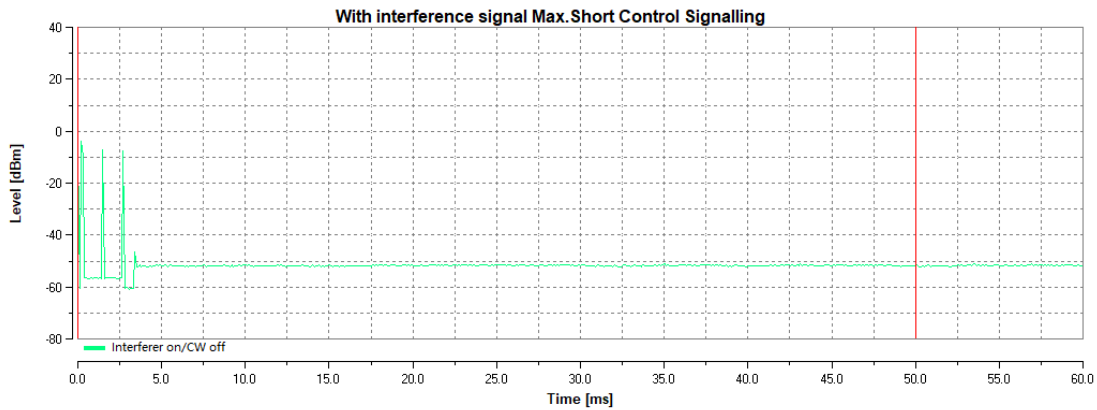



3.5.6.2. THE CHANNEL OCCUPANCY TIME RESULT

802.11b mode

The Channel occupancy Time: 0.053ms

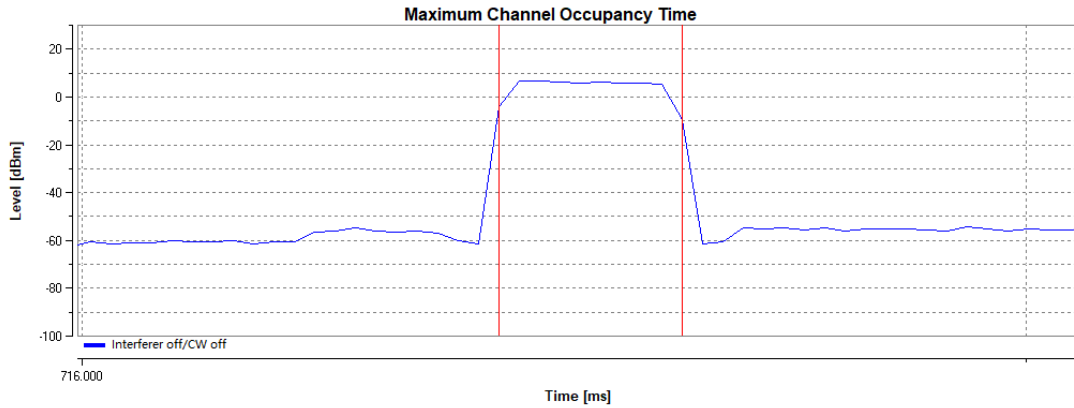

Minimum idle time: 0.114ms

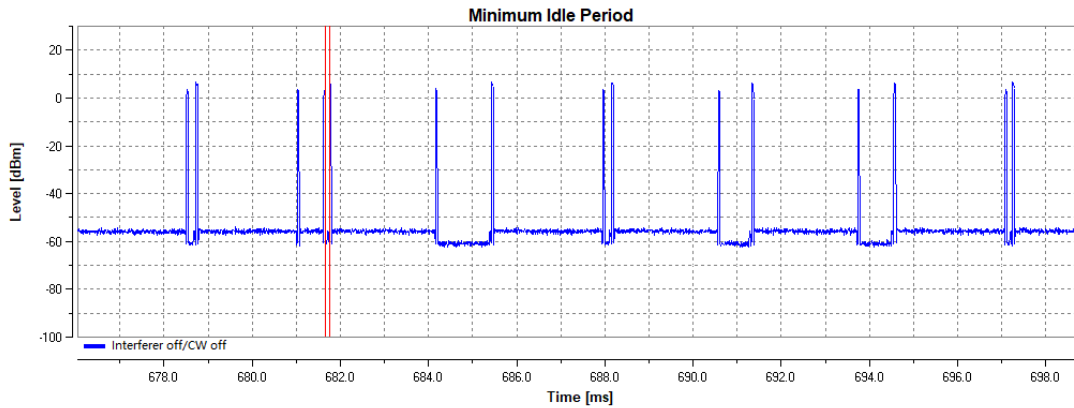



802.11g mode

The Channel occupancy Time: 0.048ms

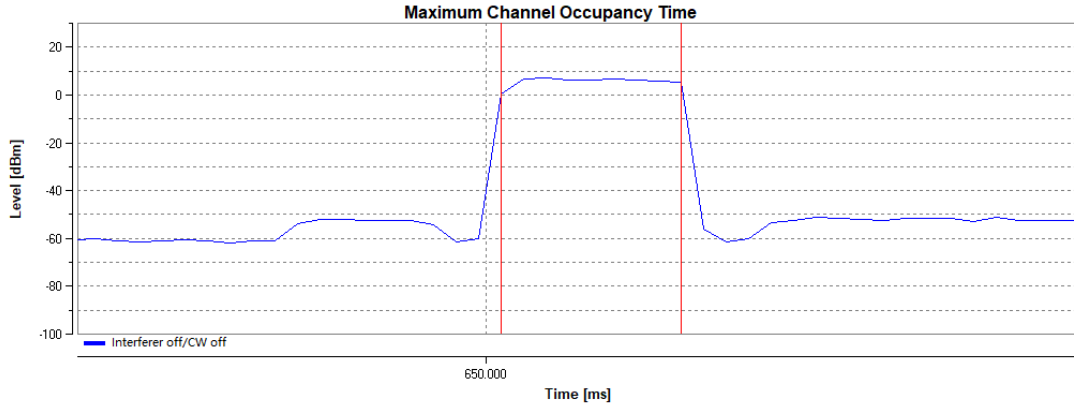

Minimum idle time: 0.125ms

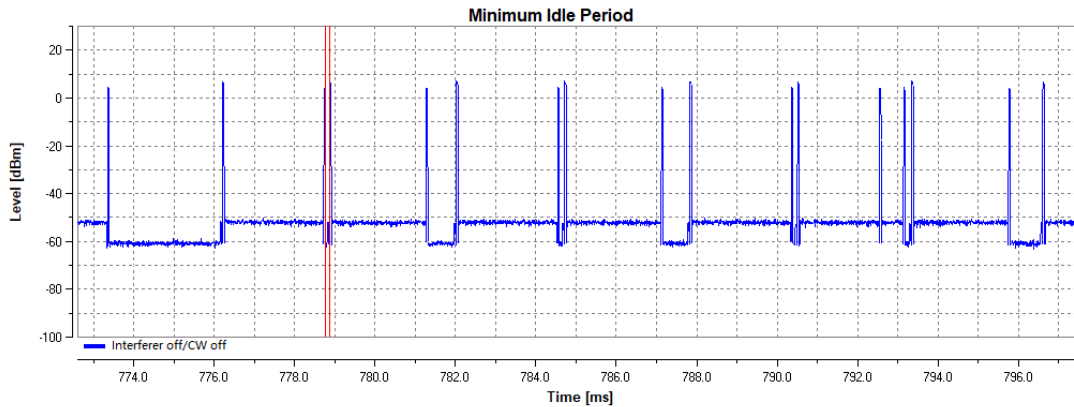



802.11nHT20 mode

The Channel occupancy Time: 0.037ms

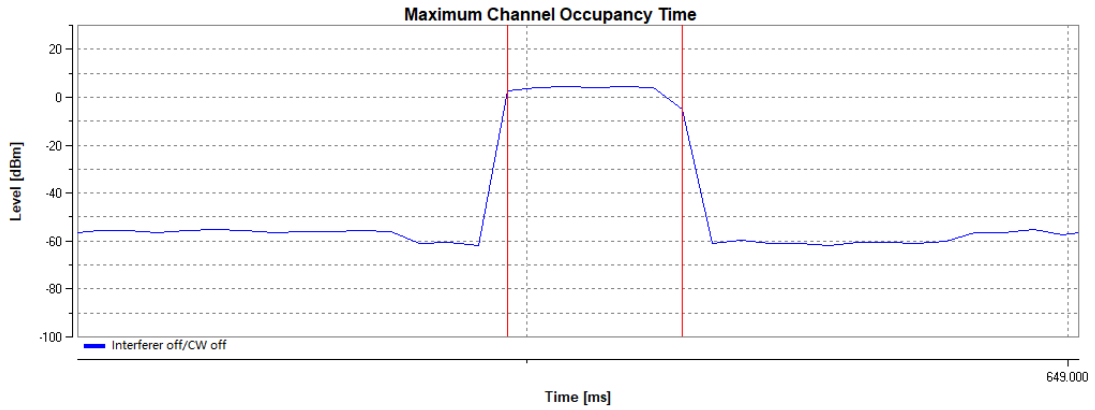

Minimum idle time: 0.279ms

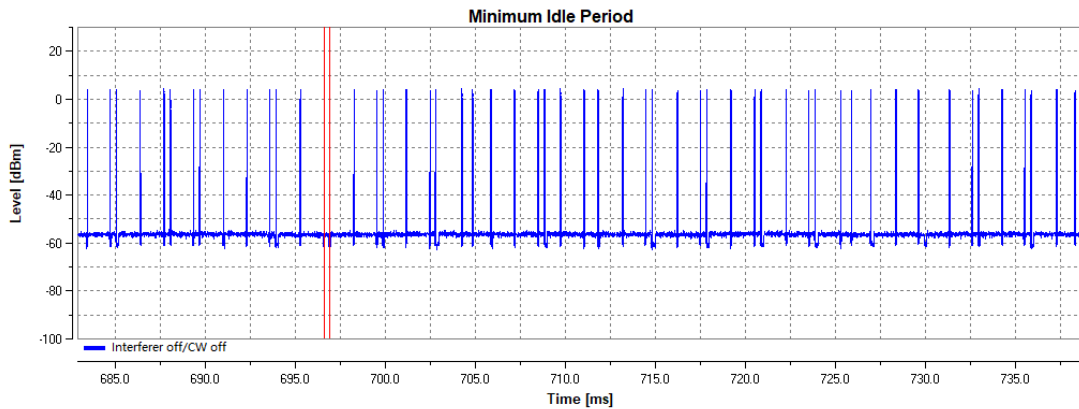



802.11nHT40 mode

The Channel occupancy Time: 0.103ms

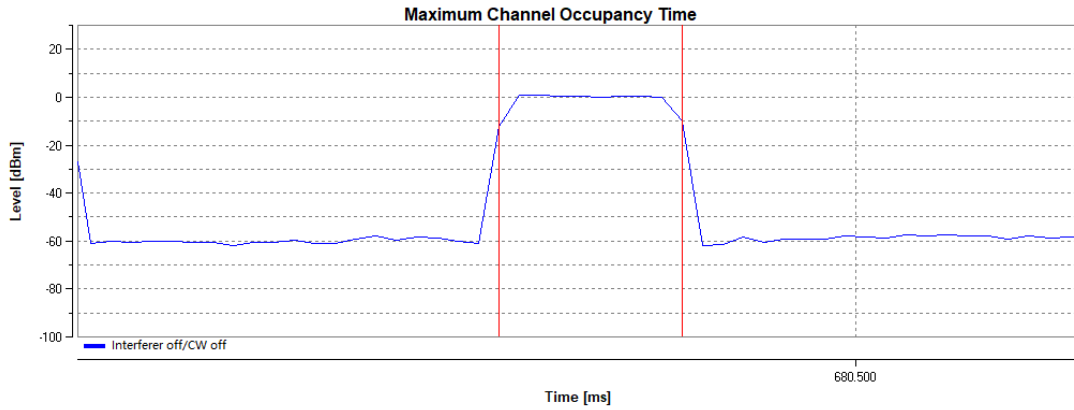

Minimum idle time: 0.053ms

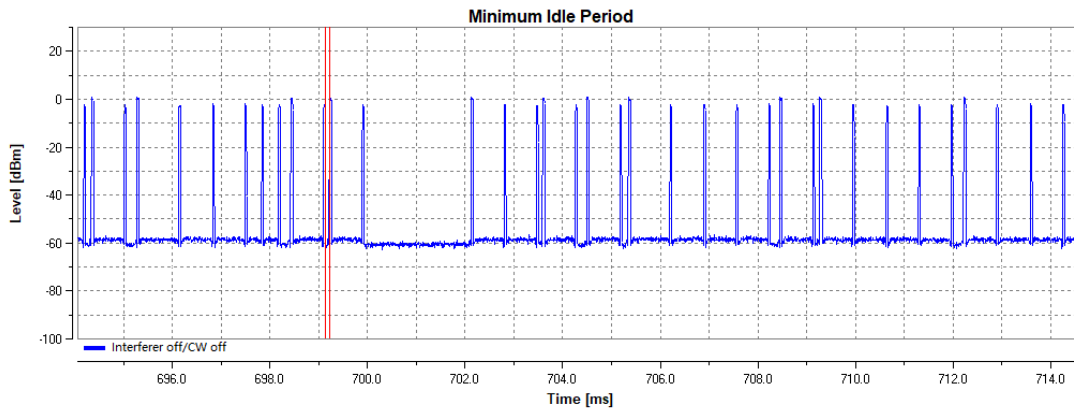



3.6. TRANSMITTER SPURIOUS EMISSIONS

3.6.1. LIMITS OF TRANSMITTER SPURIOUS EMISSIONS

Transmitter limits for narrowband spurious emissions:

Frequency Range	Maximum Power Limit (e.r.p. (≤ 1 GHz) e.i.r.p. (> 1 GHz))	Bandwidth
30 MHz to 47 MHz	-36dBm	100kHz
47 MHz to 74 MHz	-54dBm	100kHz
74 MHz to 87,5 MHz	-36dBm	100kHz
87,5 MHz to 118 MHz	-54dBm	100kHz
118 MHz to 174 MHz	-36dBm	100kHz
174 MHz to 230 MHz	-54dBm	100kHz
230 MHz to 470 MHz	-36dBm	100kHz
470 MHz to 694 MHz	-54dBm	100kHz
694 MHz to 1 GHz	-36dBm	100kHz
1GHz ~ 12.75GHz	-30dBm	1MHz

Note: These limits are e.r.p. for emissions up to 1 GHz and as e.i.r.p. for emissions above 1 GHz.

3.6.2. TEST PROCEDURE

Refer to chapter 5.4.9.2 of ETSI EN 300 328 V2.2.2.

Measurement	
<input type="checkbox"/> Conducted measurement	<input checked="" type="checkbox"/> Radiated measurement
<p>For Conducted measurement:</p> <p>The level of unwanted emissions shall be measured as their power in a specified load (conducted spurious emissions) and their effective radiated power when radiated by the cabinet or structure of the equipment with the antenna connector(s) terminated by a specified load (cabinet radiation).</p>	
<p>Conducted measurement (For equipment with multiple transmit chains):</p> <p><input type="checkbox"/> Option 1: The results for each of the transmit chains for the corresponding 1MHz segments shall be added and compared with the limits.</p> <p><input type="checkbox"/> Option 2: The results for each of the transmit chains shall be individually compared with the limits after these limits have been reduced by 10 x log (N) (number of active transmit chains)</p>	



3.6.3. DEVIATION FROM TEST STANDARD

No deviation.

3.6.4. TEST SETUP

1. For the actual test configuration, please refer to the related Item in this test report (Photographs of the Test Configuration).
2. The equipment was configured to operate under its worst case situation with respect to output power.
3. The measurement was performed at normal environmental conditions only. Controlling software has been activated to set the EUT on specific status.
4. This measurement was performed at the lowest and the highest channel.



3.6.5. TEST RESULTS

BELOW 1GHz WORST-CASE DATA

802.11b

FREQUENCY RANGE	30MHz ~ 1GHz	OPERATING CHANNEL	1
------------------------	--------------	--------------------------	---

SPURIOUS EMISSION LEVEL				
Frequency (MHz)	Antenna Polarization	Level (dBm)	Limit (dBm)	Margin (dB)
187.69	H	-58.45	-54.00	-4.45
290.64	H	-53.76	-36.00	-17.76
455.96	H	-60.60	-36.00	-24.60
497.51	H	-60.26	-54.00	-6.26
528.16	H	-62.35	-54.00	-8.35
611.87	H	-64.23	-54.00	-10.23

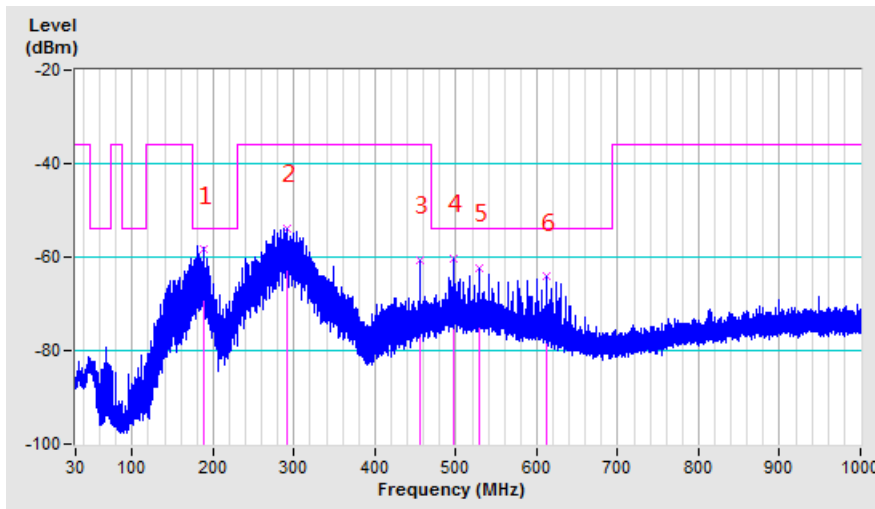



**BUREAU
VERITAS**

Test Report No.: RE2107WDG0228

FREQUENCY RANGE	30MHz ~ 1GHz	OPERATING CHANNEL	1
------------------------	--------------	--------------------------	---

SPURIOUS EMISSION LEVEL				
Frequency (MHz)	Antenna Polarization	Level (dBm)	Limit (dBm)	Margin (dB)
180.19	V	-66.30	-54.00	-12.30
307.10	V	-56.47	-36.00	-20.47
504.04	V	-62.24	-54.00	-8.24
724.26	V	-61.72	-36.00	-25.72
873.80	V	-59.65	-36.00	-23.65
948.59	V	-59.48	-36.00	-23.48

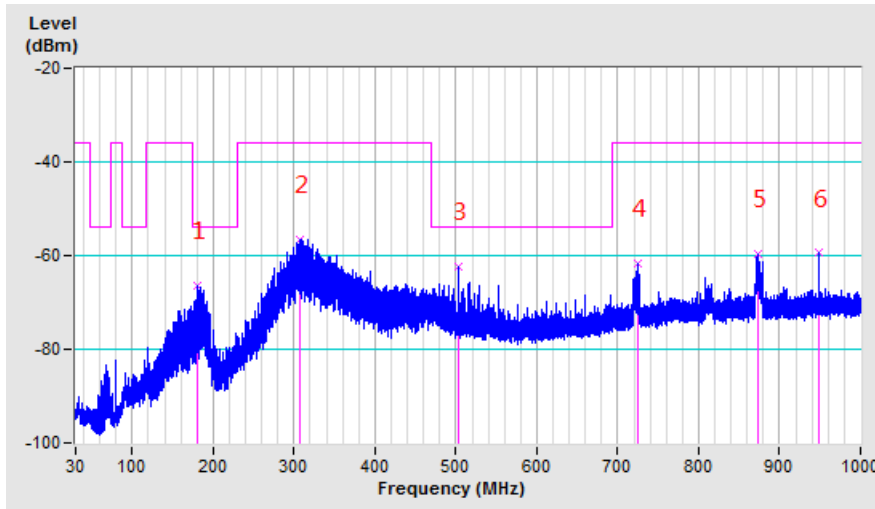



ABOVE 1GHz WORST-CASE DATA

802.11b

FREQUENCY RANGE	1GHz ~ 12.75GHz	OPERATING CHANNEL	1, 13
------------------------	-----------------	--------------------------	-------

SPURIOUS EMISSION LEVEL					
Channel	Frequency (MHz)	Antenna Polarization	Level (dBm)	Limit (dBm)	Margin (dB)
1	4824.00	H	-48.08	-30.00	-18.08
	4824.23	V	-50.09	-30.00	-20.09
	7236.00	H	-51.43	-30.00	-21.43
	7236.00	V	-54.27	-30.00	-24.27
13	4944.00	V	-48.66	-30.00	-18.66
	4944.08	H	-41.90	-30.00	-11.90
	9888.00	V	-46.13	-30.00	-16.13
	9888.09	H	-42.82	-30.00	-12.82

802.11g

FREQUENCY RANGE	1GHz ~ 12.75GHz	OPERATING CHANNEL	1, 13
------------------------	-----------------	--------------------------	-------

SPURIOUS EMISSION LEVEL					
Channel	Frequency (MHz)	Antenna Polarization	Level (dBm)	Limit (dBm)	Margin (dB)
1	4824.00	H	-55.10	-30.00	-25.10
	4824.00	V	-56.81	-30.00	-26.81
	7236.00	H	-51.34	-30.00	-21.34
	7236.00	V	-53.78	-30.00	-23.78
13	4944.00	V	-55.70	-30.00	-25.70
	4944.08	H	-48.41	-30.00	-18.41
	7416.00	H	-51.26	-30.00	-21.26
	7416.00	V	-52.06	-30.00	-22.06



802.11n (HT20)

FREQUENCY RANGE	1GHz ~ 12.75GHz	OPERATING CHANNEL	1, 13
------------------------	-----------------	--------------------------	-------

SPURIOUS EMISSION LEVEL					
Channel	Frequency (MHz)	Antenna Polarization	Level (dBm)	Limit (dBm)	Margin (dB)
1	4824.00	H	-56.95	-30.00	-26.95
	4824.00	V	-56.28	-30.00	-26.28
	7236.00	H	-53.18	-30.00	-23.18
	7236.00	V	-52.09	-30.00	-22.09
13	4942.52	H	-50.66	-30.00	-20.66
	4944.00	V	-56.20	-30.00	-26.20
	7416.00	H	-51.45	-30.00	-21.45
	7416.00	V	-51.26	-30.00	-21.26

802.11n (HT40)

FREQUENCY RANGE	1GHz ~ 12.75GHz	OPERATING CHANNEL	3, 11
------------------------	-----------------	--------------------------	-------

SPURIOUS EMISSION LEVEL					
Channel	Frequency (MHz)	Antenna Polarization	Level (dBm)	Limit (dBm)	Margin (dB)
3	4844.00	H	-55.65	-30.00	-25.65
	4844.00	V	-55.71	-30.00	-25.71
	7266.00	H	-52.91	-30.00	-22.91
	7266.00	V	-53.93	-30.00	-23.93
11	4917.45	H	-51.50	-30.00	-21.50
	4924.00	V	-57.25	-30.00	-27.25
	7386.00	H	-51.32	-30.00	-21.32
	7386.00	V	-51.99	-30.00	-21.99



RECEIVER PARAMETERS

3.7. RECEIVER SPURIOUS RADIATION

3.7.1. LIMITS OF RECEIVER SPURIOUS RADIATION

Frequency Range	Maximum Power Limit (e.r.p. (≤ 1 GHz) e.i.r.p. (> 1 GHz))
30MHz ~ 1GHz	-57dBm
1GHz ~ 12.75GHz	-47dBm

Note: These limits are e.r.p. for emissions up to 1 GHz and as e.i.r.p. for emissions above 1 GHz.

3.7.2. TEST PROCEDURE

Refer to chapter 5.4.10.2 of ETSI EN 300 328 V2.2.2.

Measurement	
<input type="checkbox"/> Conducted measurement	<input checked="" type="checkbox"/> Radiated measurement
<p><u>For Conducted measurement:</u> The level of unwanted emissions shall be measured as their power in a specified load (conducted spurious emissions) and their effective radiated power when radiated by the cabinet or structure of the equipment with the antenna connector(s) terminated by a specified load (cabinet radiation).</p>	
<p><u>Conducted measurement (For equipment with multiple transmit chains):</u></p> <p><input type="checkbox"/> Option 1: The results for each of the transmit chains for the corresponding 1MHz segments shall be added and compared with the limits.</p> <p><input type="checkbox"/> Option 2: The results for each of the transmit chains shall be individually compared with the limits after these limits have been reduced by $10 \times \log(N)$ (number of active transmit chains)</p>	

3.7.3. DEVIATION FROM TEST STANDARD

No deviation.

3.7.4. TEST SETUP

1. For the actual test configuration, please refer to the related Item in this test report (Photographs of the Test Configuration).
2. Testing was performed when the equipment was in a receive-only mode.
3. The measurement was performed at normal environmental conditions only. Controlling software has been activated to set the EUT on specific status.
4. This measurement was performed at the lowest and the highest channel.



3.7.5. TEST RESULTS

RX WORST-CASE DATA

FREQUENCY RANGE	30MHz ~ 1GHz	OPERATING CHANNEL	1
------------------------	--------------	--------------------------	---

SPURIOUS EMISSION LEVEL				
Frequency (MHz)	Antenna Polarization	Level (dBm)	Limit (dBm)	Margin (dB)
181.03	H	-77.91	-57.00	-20.91
200.20	H	-75.57	-57.00	-18.57
240.46	H	-66.70	-57.00	-9.70
265.16	H	-71.24	-57.00	-14.24
310.46	H	-74.12	-57.00	-17.12
545.13	H	-71.44	-57.00	-14.44

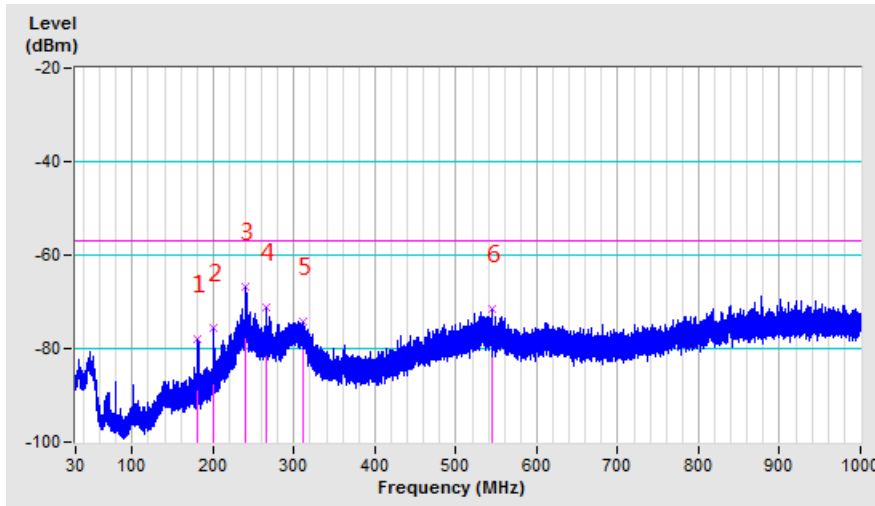



**BUREAU
VERITAS**

Test Report No.: RE2107WDG0228

FREQUENCY RANGE	30MHz ~ 1GHz	OPERATING CHANNEL	1
------------------------	--------------	--------------------------	---

SPURIOUS EMISSION LEVEL				
Frequency (MHz)	Antenna Polarization	Level (dBm)	Limit (dBm)	Margin (dB)
241.33	V	-75.76	-57.00	-18.76
305.48	V	-68.78	-57.00	-11.78
596.74	V	-74.62	-57.00	-17.62
720.70	V	-63.14	-57.00	-6.14
809.52	V	-65.18	-57.00	-8.18
874.03	V	-64.64	-57.00	-7.64

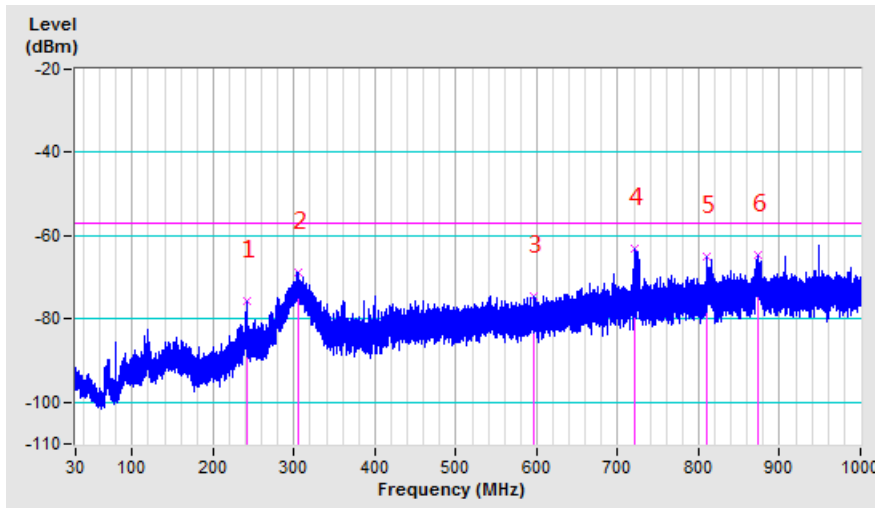



RX ABOVE 1GHz DATA

FREQUENCY RANGE	1GHz ~ 12.75GHz	OPERATING CHANNEL	1, 13
------------------------	-----------------	--------------------------	-------

SPURIOUS EMISSION LEVEL					
Channel	Frequency (MHz)	Antenna Polarization	Level (dBm)	Limit (dBm)	Margin (dB)
1	4824.00	H	-58.59	-47.00	-11.59
	4824.00	V	-57.48	-47.00	-10.48
	7236.00	H	-52.21	-47.00	-5.21
	7236.00	V	-51.47	-47.00	-4.47
13	4944.00	H	-54.85	-47.00	-7.85
	4944.00	V	-56.49	-47.00	-9.49
	7416.00	H	-51.96	-47.00	-4.96
	7416.00	V	-50.85	-47.00	-3.85



3.8. RECEIVER BLOCKING

3.8.1. LIMITS OF RECEIVER BLOCKING

This requirement applies to all receiver categories.

Receiver Category		
<input checked="" type="checkbox"/> Category 1 (EIRP > 10dBm)	<input type="checkbox"/> Category 2 (EIRP ≤ 10dBm)	<input type="checkbox"/> Category 3 (EIRP ≤ 0dBm)
Minimum performance criterion	<input checked="" type="checkbox"/> PER ≤ 10%	
	<input type="checkbox"/> Alternative performance criteria (See note)	
Note: The manufacturer was declared the minimum performance criterion shall be no loss of the wireless transmission function needed for the intended use of the equipment.		

Receiver Category 1 Equipment			
Wanted signal mean power from companion device (dBm) (See note 1 and 4)	Blocking Signal Frequency (MHz)	Blocking Signal Power (dBm) (See note 4)	Type of blocking signal
(-133dBm + 10xlog ₁₀ (OCBW) Or -68dBm whichever is less (See note 2)	2 380	-34	CW
	2 504		
(-139dBm + 10xlog ₁₀ (OCBW) Or -74dBm whichever is less (See note 3)	2 300		
	2 330		
	2 360		
	2 524		
	2 584		
	2 674		
<p>NOTE 1: OCBW is in Hz.</p> <p>NOTE 2: In case of radiated measurements using a companion device and the level of the wanted signal from the companion device cannot be determined, a relative test may be performed using a wanted signal up to P_{min} + 26 dB where P_{min} is the minimum level of wanted signal required to meet the minimum performance criteria as defined in clause 4.3.1.12.3 in the absence of any blocking signal.</p> <p>NOTE 3: In case of radiated measurements using a companion device and the level of the wanted signal from the companion device cannot be determined, a relative test may be performed using a wanted signal up to P_{min} + 20 dB where P_{min} is the minimum level of wanted signal required to meet the minimum performance criteria as defined in clause 4.3.1.12.3 in the absence of any blocking signal.</p> <p>NOTE 4: The level specified is the level at the UUT receiver input assuming a 0 dBi antenna assembly gain. In case of conducted measurements, this level has to be corrected for the (in-band) antenna assembly gain (G). In case of radiated measurements, this level is equivalent to a power flux density (PFD) in front of the UUT antenna with the UUT being configured/positioned as recorded in clause 5.4.3.2.2.</p>			



Receiver Category 2 Equipment			
Wanted signal mean power from companion device (dBm)(See note 1 and 3)	Blocking Signal Frequency (MHz)	Blocking Signal Power (dBm) (See note 3)	Type of blocking signal
(-139dBm+10xlog ₁₀ (OCBW)+10dB) Or -74dBm+10dB whichever is less(See note 2)	2 380	-34	CW
	2 504		
	2 300		
	2 584		
<p>NOTE 1: OCBW is in Hz.</p> <p>NOTE 2: In case of radiated measurements using a companion device and the level of the wanted signal from the companion device cannot be determined, a relative test may be performed using a wanted signal up to P_{min} + 26 dB where P_{min} is the minimum level of wanted signal required to meet the minimum performance criteria as defined in clause 4.3.1.12.3 in the absence of any blocking signal.</p> <p>NOTE 3: The level specified is the level at the UUT receiver input assuming a 0 dBi antenna assembly gain. In case of conducted measurements, this level has to be corrected for the (in-band) antenna assembly gain (G). In case of radiated measurements, this level is equivalent to a power flux density (PFD) in front of the UUT antenna with the UUT being configured/positioned as recorded in clause 5.4.3.2.2.</p>			

Receiver Category 3 Equipment			
Wanted signal mean power from companion device (dBm) (See note 1 and 3)	Blocking Signal Frequency (MHz)	Blocking Signal Power (dBm) (See note 3)	Type of blocking signal
(-139dBm+10xlog ₁₀ (OCBW)+20dB) Or -74dBm+20dB whichever is less(See note 2)	2 380	-34	CW
	2 504		
	2 300		
	2 584		
<p>NOTE 1: OCBW is in Hz.</p> <p>NOTE 2: In case of radiated measurements using a companion device and the level of the wanted signal from the companion device cannot be determined, a relative the test may be performed using a wanted signal up to P_{min} + 30 dB where P_{min} is the minimum level of wanted signal required to meet the minimum performance criteria as defined in clause 4.3.1.12.3 in the absence of any blocking signal.</p> <p>NOTE 3: The level specified is the level at the UUT receiver input assuming a 0 dBi antenna assembly gain. In case of conducted measurements, this level has to be corrected for the (in-band) antenna assembly gain (G). In case of radiated measurements, this level is equivalent to a power flux density (PFD) in front of the UUT antenna with the UUT being configured/positioned as recorded in clause 5.4.3.2.2.</p>			

3.8.2. TEST PROCEDURE

Refer to chapter 5.4.11.2. of ETSI EN 300 328 V2.2.2.

Measurement	
<input checked="" type="checkbox"/> Conducted measurement	<input type="checkbox"/> Radiated measurement

3.8.3. DEVIATION FROM TEST STANDARD

No deviation.



3.8.4. TEST SETUP CONFIGURATION

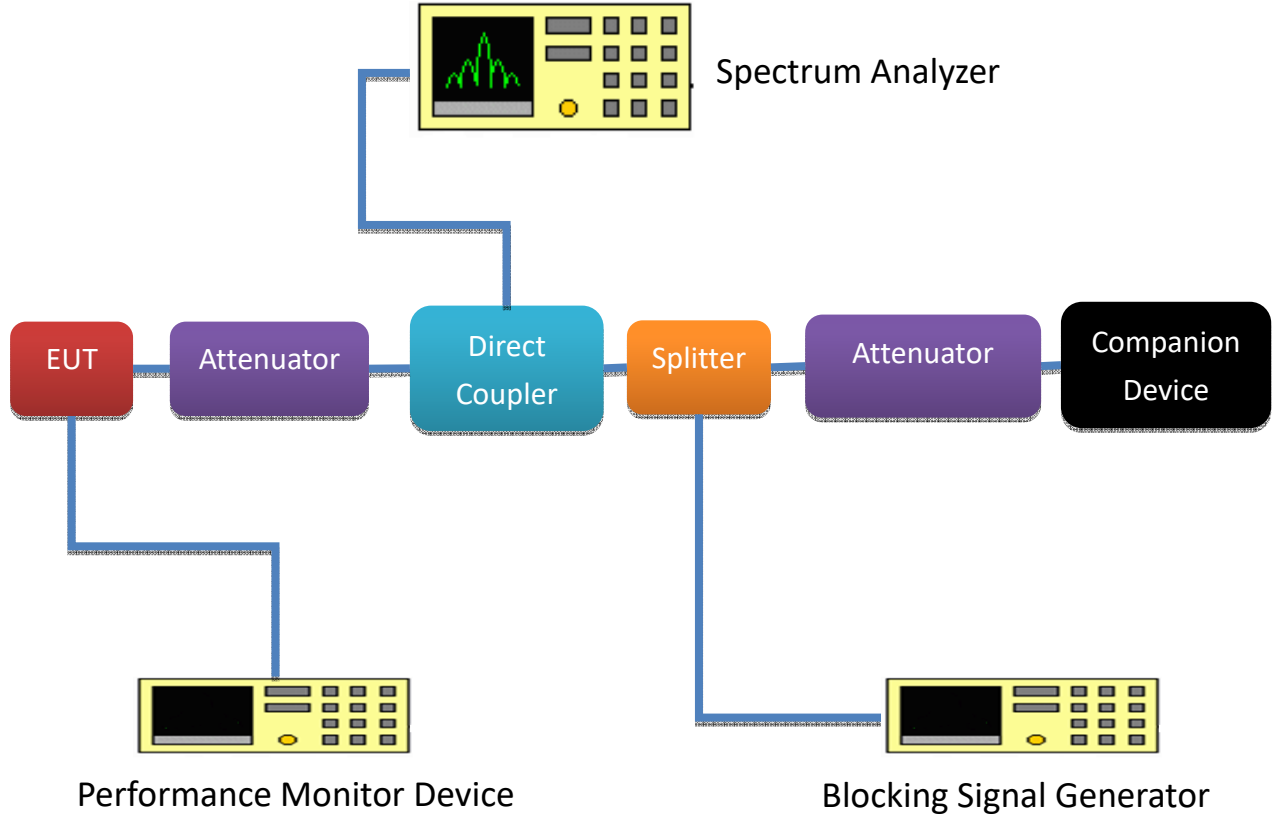



3.8.5. TEST RESULT

802.11b

Receiver Category 1 Equipment

Receiver blocking performance when operating at the lowest operating channel(CH1)				
OCBW _{min} : 13.28MHz		antenna gain(G) : 2dBi		
The actual blocking signal power(Note1)		<input checked="" type="checkbox"/> at the antenna connector		
		<input type="checkbox"/> in front of the antenna		
Note1: For the conducted measurements , the level shall be corrected as follows: the actual blocking signal power = blocking signal power + antenna gain				
Wanted signal mean power from companion device (dBm)	Blocking signal frequency (MHz)	The actual blocking signal power (dBm)	PER(%)	Pass/Fail
-68	2380	-32	0.2	PASS
-74	2300		0	PASS
	2330		0.1	PASS
	2360		0.5	PASS

Receiver blocking performance when operating at the lowest operating channel(CH13)				
OCBW _{min} : 13.28MHz		antenna gain(G) : 2dBi		
The actual blocking signal power(Note1)		<input checked="" type="checkbox"/> at the antenna connector		
		<input type="checkbox"/> in front of the antenna		
Note1: For the conducted measurements , the level shall be corrected as follows: the actual blocking signal power = blocking signal power + antenna gain				
Wanted signal mean power from companion device (dBm)	Blocking signal frequency (MHz)	The actual blocking signal power (dBm)	PER(%)	Pass/Fail
-68	2504	-32	0	PASS
-74	2524		0	PASS
	2584		0	PASS
	2674		0	PASS



4 PHOTOGRAPHS OF THE TEST CONFIGURATION

SPURIOUS EMISSION TEST BELOW 1GHz

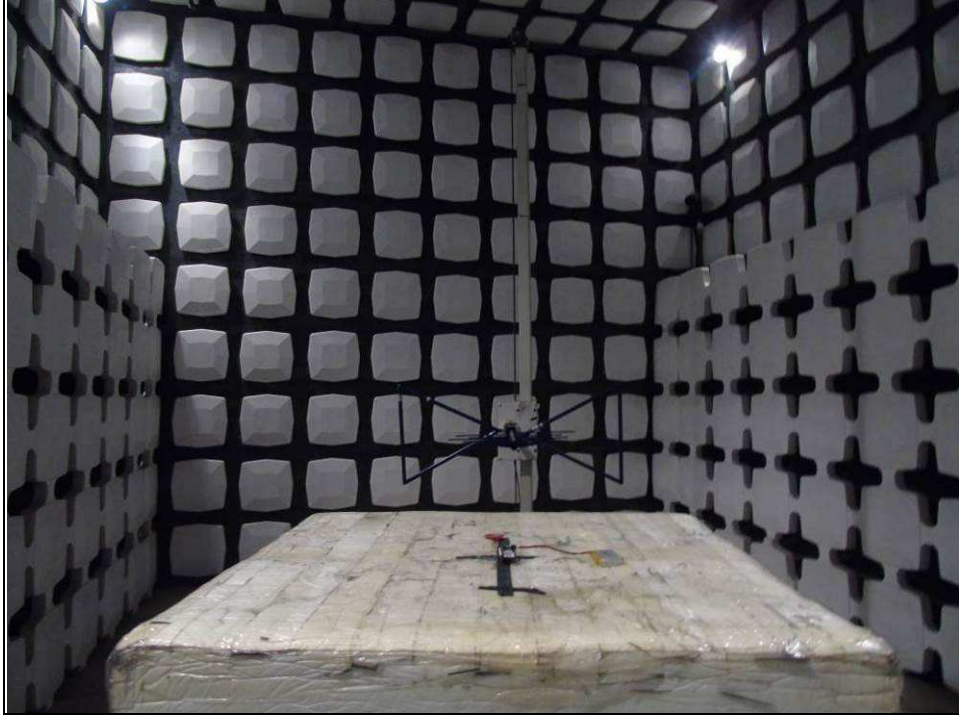

SPURIOUS EMISSION TEST ABOVE 1GHz





**BUREAU
VERITAS**

Test Report No.: RE2107WDG0228

ADAPTIVITY TEST



RECEIVING BLOCKING

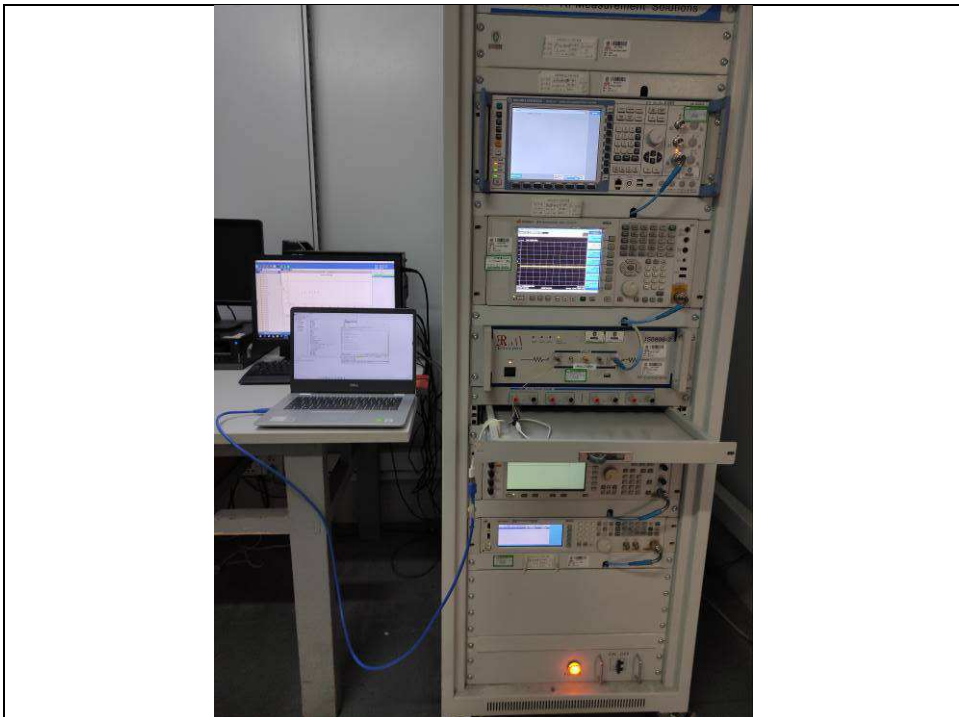



**BUREAU
VERITAS**

Test Report No.: RE2107WDG0228

5 APPENDIX A – MODIFICATIONS RECORDERS FOR ENGINEERING CHANGES TO THE EUT BY THE LAB

No any modifications were made to the EUT by the lab during the test.

--- END ---