

# TEST REPORT

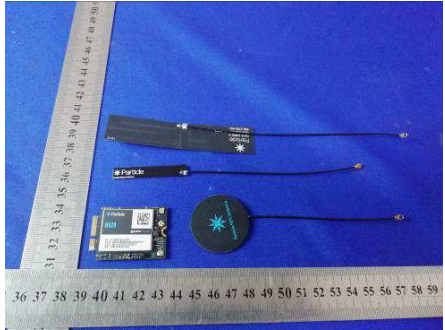

Applicant	Particle Industries, Inc
Address	126 Post St, 4th floor, San Francisco, CA 94108 USA

Manufacturer or Supplier	Particle Industries, Inc	
Address	126 Post St, 4th floor, San Francisco, CA 94108 USA	
Product	B SOM	
Brand Name	Particle Industries, Inc	
Model	B520	
Additional Model & Model Difference	B523, see section 2.1 note	
Date of tests	Jan. 04, 2020 ~ Apr. 17, 2020	

The submitted sample of the above equipment has been tested according to the requirements of the following standards:

EN 300 328 V2.2.2 (2019-07)

**CONCLUSION: The submitted sample was found to COMPLY with the test requirement**

Tested by Breeze Jiang Project Engineer / EMC Department	Approved by Glyn He Assistant Manager / EMC Department
	  Date: May 19, 2020

This report is governed by, and incorporates by reference, CPS Conditions of Service as posted at the date of issuance of this report at <http://www.bureauveritas.com/home/about-us/our-business/cps/about-us/terms-conditions> and is intended for your exclusive use. Any copying or replication of this report to or for any other person or entity, or use of our name or trademark, is permitted only with our prior written permission. This report sets forth our findings solely with respect to the test samples identified herein. The results set forth in this report are not indicative or representative of the quality or characteristics of the lot from which a test sample was taken or any similar or identical product unless specifically and expressly noted. Our report includes all of the tests requested by you and the results thereof based upon the information that you provided to us. Measurement uncertainty is only provided upon request for accredited tests. You have 60 days from date of issuance of this report to notify us of any material error or omission caused by our negligence or if you require measurement uncertainty; provided, however, that such notice shall be in writing and shall specifically address the issue you wish to raise. A failure to raise such issue within the prescribed time shall constitute your unqualified acceptance of the completeness of this report, the tests conducted and the correctness of the report contents.



# TABLE OF CONTENTS

**RELEASE CONTROL RECORD ..... 4**

**1. SUMMARY OF TEST RESULTS ..... 5**

1.1. TEST INSTRUMENTS ..... 6

1.2. MEASUREMENT UNCERTAINTY ..... 8

1.3. MAXIMUM MEASUREMENT UNCERTAINTY ..... 8

**2. GENERAL INFORMATION..... 9**

2.1. GENERAL DESCRIPTION OF EUT ..... 9

2.2. DESCRIPTION OF TEST MODES ..... 10

2.2.1. TEST MODE APPLICABILITY AND TESTED CHANNEL DETAIL.....11

2.3. GENERAL DESCRIPTION OF APPLIED STANDARDS ..... 14

2.4. DESCRIPTION OF SUPPORT UNITS ..... 14

**3 TEST PROCEDURES AND RESULTS ..... 15**

**TRANSMITTER PARAMETERS ..... 15**

3.1. RF OUTPUT POWER ..... 15

3.1.1. LIMITS OF RF OUTPUT POWER ..... 15

3.1.2. TEST PROCEDURE ..... 15

3.1.3. DEVIATION FROM TEST STANDARD ..... 15

3.1.4. TEST SETUP ..... 15

3.1.5. TEST RESULTS ..... 16

3.2. POWER SPECTRAL DENSITY ..... 17

3.2.1. LIMIT OF POWER SPECTRAL DENSITY ..... 17

3.2.2. TEST PROCEDURE ..... 17

3.2.3. DEVIATION FROM TEST STANDARD ..... 17

3.2.4. TEST SETUP ..... 17

3.2.5. TEST RESULTS ..... 18

3.3. OCCUPIED CHANNEL BANDWIDTH ..... 19

3.3.1. LIMIT OF OCCUPIED CHANNEL BANDWIDTH..... 19

3.3.2. TEST PROCEDURE ..... 19

3.3.3. DEVIATION FROM TEST STANDARD ..... 19

3.3.4. TEST SETUP ..... 19

3.3.5. TEST RESULTS ..... 20

3.4. TRANSMITTER UNWANTED EMISSIONS IN THE OUT-OF-BAND DOMAIN ..... 21

3.4.1. LIMITS OF TRANSMITTER UNWANTED EMISSIONS IN THE OUT-OF-BAND DOMAIN 21

3.4.2. TEST PROCEDURE ..... 21

3.4.3. DEVIATION FROM TEST STANDARD ..... 21

3.4.4. TEST SETUP ..... 22

3.4.5. TEST RESULTS ..... 22

3.5. TRANSMITTER SPURIOUS EMISSIONS..... 23

3.5.1. LIMITS OF TRANSMITTER SPURIOUS EMISSIONS..... 23

3.5.2. TEST PROCEDURE ..... 23

3.5.3. DEVIATION FROM TEST STANDARD ..... 24

3.5.4. TEST SETUP ..... 24

3.5.5. TEST RESULTS ..... 25

**RECEIVER PARAMETERS ..... 30**

3.6. RECEIVER SPURIOUS RADIATION ..... 30

3.6.1. LIMITS OF RECEIVER SPURIOUS RADIATION ..... 30

3.6.2. TEST PROCEDURE ..... 30

3.6.3. DEVIATION FROM TEST STANDARD ..... 30



**BUREAU  
VERITAS**

**Test Report No.: RE191231N001-2**

3.6.4.	TEST SETUP .....	30
3.6.5.	TEST RESULTS .....	31
3.7.	RECEIVER BLOCKING .....	36
3.7.1.	LIMITS OF RECEIVER BLOCKING .....	36
3.7.2.	TEST PROCEDURE.....	37
3.7.3.	DEVIATION FROM TEST STANDARD .....	37
3.7.4.	TEST SETUP CONFIGURATION.....	38
3.7.5.	TEST RESULT .....	39
<b>4</b>	<b>PHOTOGRAPHS OF THE TEST CONFIGURATION .....</b>	<b>41</b>
<b>5</b>	<b>APPENDIX A – MODIFICATIONS RECORDERS FOR ENGINEERING CHANGES TO THE EUT BY THE LAB.....</b>	<b>43</b>



**BUREAU**  
**VERITAS**

Test Report No.: RE191231N001-2

## RELEASE CONTROL RECORD

ISSUE NO.	REASON FOR CHANGE	DATE ISSUED
RE191231N001-2	Original release	May 19, 2020



## 1. SUMMARY OF TEST RESULTS

The EUT has been tested according to the following specifications:

EN 300 328 V2.2.2		
Clause	Test Parameter	Results
	<b>TRANSMITTER PARAMETERS</b>	
4.3.2.2	RF Output Power	Pass
4.3.2.3	Power Spectral Density	Pass
4.3.2.6	Adaptivity	Not Applicable (Note)
4.3.2.7	Occupied Channel Bandwidth	Pass
4.3.2.8	Transmitter unwanted emission in the OOB domain	Pass
4.3.2.9	Transmitter unwanted emissions in the spurious domain	Pass
4.3.2.12	Geo-location capability	Not Applicable
	<b>RECEIVER PARAMETERS</b>	
4.3.2.10	Receiver Spurious Emissions	Pass
4.3.2.11	Receiver Blocking	Pass

Note: These requirements do not apply for equipment with a maximum declared RF Output power of less than 10 dBm EIRP or for equipment when operating in a mode where the RF Output power is less than 10 dBm EIRP.



### 1.1. TEST INSTRUMENTS

Equipment	Manufacturer	Model No.	Serial No.	Last Cal.	Next Cal.
EMI Test Receiver	Rohde&Schwarz	ESU40	100449	Mar. 18,20	Mar. 17,21
Signal and Spectrum Analyzer	Rohde&Schwarz	FSV40	101094	Mar. 18,20	Mar. 17,21
Bilog Antenna	Teseq	CBL 6111D	30643	Jun. 23,19	Jun. 22,20
Horn Antenna	ETS-Lindgren	3117	00062558	Jun. 23,19	Jun. 22,20
GPS Generator+ Antenna	TOJOIN	GNSS-5000A	E1-010119	N/A	N/A
3m Semi-anechoic Chamber	ETS-LINDGREN	9m*6m*6m	NSEMC003	Apr. 21,19	Apr. 20,20
Test Software	ADT	ADT_Radiated_V7.6.15.9.2	N/A	N/A	N/A
Horn Antenna (15GHz-40GHz)	SCHWARZBECK	BBHA 9170	BBHA9170147	Jun. 23,19	Jun. 22,20
Amplifier	Burgeon	BPA-530	100220	Mar. 15,20	Mar. 14,21
Broadband Preamplifier (1GHz~18GHz)	SCHWARZBECK	BBV9718	305	Apr. 21,19	Apr. 20,20
Pre-Amplifier (18GHz-40GHz)	EMCI	EMC 184045	980102	Mar. 04,20	Mar. 03,21
Power Sensor	Keysight	U2021XA	MY55060016	May 22,19	May 21,20
Power Sensor	Keysight	U2021XA	MY55060018	May 22,19	May 21,20
Digital Multimeter	FLUKE	15B	A1220009DG	Sep. 19,19	Sep. 18,20
Humid & Temp Programmable Tester	Haida	HD-2257	110807201	Nov.15,18	Nov. 14,19
Oscilloscope	Agilent	DSO9254A	MY51260160	Sep. 18,19	Sep. 17,20
Signal and Spectrum Analyzer	Rohde&Schwarz	FSV7	102331	May 22,19	May 21,20
Spectrum Analyzer	Keysight	N9020A	MY55400499	Mar. 18,20	Mar. 17,21
Signal Generator	Agilent	N5183A	MY50140980	Sep. 19,19	Sep. 18,20
MXG-B RF Vector Signal Generator	Keysight	N5182B	MY56200288	Sep. 12,19	Sep. 11,20
Wireless Connectivity Tester	Rohde&Schwarz	CMW270	100908	Sep. 18,19	Sep. 17,20
Vector Signal Generator	Rohde&Schwarz	SMBV100A	257579	Sep. 12,19	Sep. 11,20
BLUETOOTH TESTER	Rohde&Schwarz	CBT32	100811	May 20,19	May 19,20
Attenuator	MINI	BW-S10W2+	S130129FGE2	N/A	N/A

**NOTE:**

1. The test was performed in 966 Chamber and RF Oven room.
2. The calibration interval of the above test instruments is 12 months and the calibrations are traceable to CEPREI/CHINA, GRGT/CHINA and NIM/CHINA.
3. The horn antenna is used only for the measurement of emission frequency above 1GHz if tested.

**For Receiver Blocking test and Adaptivity test:**

Equipment	Manufacturer	Model No.	Serial No.	Last Cal.	Next Cal.
Wireless Connectivity Tester	Rohde&Schwarz	CMW270	100908	Sep. 18,19	Sep. 17,20
Signal Analyzer	Rohde&Schwarz	FSV7	102331	May 14, 19	May 13, 20
Spectrum Analyzer	Keysight	N9020A	MY55400499	Mar. 18,20	Mar. 17,21
Signal Generator	Agilent	N5183A	MY50140980	Sep. 19,19	Sep. 18,20
MXG-B RF Vector Signal Generator	Keysight	N5182B	MY56200288	Sep. 12,19	Sep. 11,20
Power Sensor	Keysight	U2021XA	MY55060016	May 22,19	May 21,20
Power Sensor	Keysight	U2021XA	MY55060018	May 22,19	May 21,20
Vector Signal Generator	Rohde&Schwarz	SMBV100A	257579	Sep. 12,19	Sep. 11,20
Agile Signal Generator	Agilent	8645A	Agilent	Sep. 12,19	Sep. 11,20
Shield Box	TOJOIN	MS4345-C	SZA18A 3038	N/A	N/A
Attenuator	TOJOIN	CHB-8-90-1-B 50SMA	0803002	N/A	N/A
COM Power Splitter	TOJOIN	PS-TX-2B	020801	N/A	N/A
COM Power Splitter	TOJOIN	PS-TX-2B	020802	N/A	N/A
Test software	TonScend	JS1120-3-1	JS-001	N/A	N/A

**NOTE:**

1. The test was performed in RF Oven room.
2. The calibration interval of the above test instruments is 12 months and the calibrations are traceable to CEPREI/CHINA, GRGT/CHINA and NIM/CHINA.



### 1.2. MEASUREMENT UNCERTAINTY

Where relevant, the following measurement uncertainty levels have been estimated for tests performed on the EUT:

This uncertainty represents an expanded uncertainty expressed at approximately the 95% confidence level using a coverage factor of k=2.

Parameter	Uncertainty
Occupied Channel Bandwidth	±1.132 %
RF output power, conducted	±0.56dB
Power Spectral Density, conducted	±1.017dB
Unwanted Emissions, conducted	±1.017dB
All emissions, radiated	±4.84dB
Temperature	±0.23°C
Supply voltages	±0.01 %
Time	±4 %

### 1.3. MAXIMUM MEASUREMENT UNCERTAINTY

For the test methods, according to ETSI EN 300 328 standard, the measurement uncertainty figures shall be calculated in accordance with ETR 100 028-1 [4] and shall correspond to an expansion factor (coverage factor) k = 1,96 or k = 2 (which provide confidence levels of respectively 95 % and 95,45 % in the case where the distributions characterizing the actual measurement uncertainties are normal (Gaussian)).

#### Maximum measurement uncertainty

Parameter	Uncertainty
Occupied Channel Bandwidth	±5 %
RF output power, conducted	±1,5 dB
Power Spectral Density, conducted	±3 dB
Unwanted Emissions, conducted	±3 dB
All emissions, radiated	±6 dB
Temperature	±3 °C
Supply voltages	±3 %
Time	±5 %





## 2. GENERAL INFORMATION

### 2.1. GENERAL DESCRIPTION OF EUT

<b>PRODUCT</b>	B SOM
<b>TEST MODEL</b>	B520
<b>ADDITIONAL MODEL</b>	B523
<b>NOMINAL VOLTAGE</b>	3V3 : DC +3.3V (2.8-3.6V), VCC: 3.8V (DC+3.3-4.3V)
<b>OPERATING TEMPERATURE RANGE</b>	-40 ~ +85°C
<b>MODULATION TECHNOLOGY</b>	DTS
<b>MODULATION TYPE</b>	BT-LE GFSK(1, 2 Mbps) for DTS
<b>OPERATING FREQUENCY</b>	2402MHz-2480MHz
<b>ADPTIVE/NON-ADPTIVE</b>	<input type="checkbox"/> non-adaptive Equipment <input checked="" type="checkbox"/> adaptive Equipment without the possibility to switch to a non-adaptive mode <input type="checkbox"/> adaptive Equipment which can also operate in a non-adaptive mode
<b>EIRP POWER (MAX.)</b>	7.33dBm
<b>ANTENNA TYPE</b>	FPCB Antenna, 2dBi Gain
<b>CABLE SUPPLIED</b>	N/A

Note:

1. The above EUT information is declared by manufacturer and for more detailed features description, please refer to the manufacturer's specifications or user's manual.
2. For the test results, the EUT had been tested with all conditions, but only the worst case was shown in test report.
3. Please refer to the EUT photo document (Reference No.: 191231N001) for detailed product photo.
4. The EUT is wireless module, it no any accessories, the test standard and items were specified by applicant.



## 2.2. DESCRIPTION OF TEST MODES

40 channels are provided to BT-LE (GFSK)

CHANNEL	FREQ. (MHZ)	CHANNEL	FREQ. (MHZ)	CHANNEL	FREQ. (MHZ)	CHANNEL	FREQ. (MHZ)
0	2402	10	2422	20	2442	30	2462
1	2404	11	2424	21	2444	31	2464
2	2406	12	2426	22	2446	32	2466
3	2408	13	2428	23	2448	33	2468
4	2410	14	2430	24	2450	34	2470
5	2412	15	2432	25	2452	35	2472
6	2414	16	2434	26	2454	36	2474
7	2416	17	2436	27	2456	37	2476
8	2418	18	2438	28	2458	38	2478
9	2420	19	2440	29	2460	39	2480



**2.2.1. TEST MODE APPLICABILITY AND TESTED CHANNEL DETAIL**

EUT CONFIGURE MODE	APPLICABLE TO								DESCRIPTION
	ROP	PSD	AD	OCB	OOB	SE<1G	SE≥1G	RB	
A	√	√	-	√	√	-	-	√	DC 3.3V and DC3.8V from Som test board V05A

Where **ROP**: RF Output Power **PSD**: Power Spectral Density  
**AD**: Adaptivity (Channel Access Mechanism) **OCB**: Occupied Channel Bandwidth  
**OOB**: Transmitter unwanted emission in the out-of-band domain **SE<1G**: Spurious Emissions below 1GHz  
**SE≥1G**: Spurious Emissions above 1GHz **RB**: Receiver Blocking

**RF OUTPUT POWER TEST:**

- Pre-Scan has been conducted to determine the worst-case mode from all possible combinations between available modulations, data rates and antenna ports (if EUT with antenna diversity architecture).
- Following channel(s) was (were) selected for the final test as listed below.

MODE	AVAILABLE CHANNEL	TESTED CHANNEL	MODULATION TECHNOLOGY	MODULATION TYPE	DATA RATE (Mbps)
BT-LE	0 to 39	0,19, 39	DTS	GFSK	1.0
BT-LE	0 to 39	0,19, 39	DTS	GFSK	2.0

**POWER SPECTRAL DENSITY TEST:**

- Pre-Scan has been conducted to determine the worst-case mode from all possible combinations between available modulations, data rates and antenna ports (if EUT with antenna diversity architecture).
- Following channel(s) was (were) selected for the final test as listed below.

MODE	AVAILABLE CHANNEL	TESTED CHANNEL	MODULATION TECHNOLOGY	MODULATION TYPE	DATA RATE (Mbps)
BT-LE	0 to 39	0,19, 39	DTS	GFSK	1.0
BT-LE	0 to 39	0,19, 39	DTS	GFSK	2.0

**OCCUPIED CHANNEL BANDWIDTH TEST:**

- Pre-Scan has been conducted to determine the worst-case mode from all possible combinations between available modulations, data rates and antenna ports (if EUT with antenna diversity architecture).
- Following channel(s) was (were) selected for the final test as listed below.

MODE	AVAILABLE CHANNEL	TESTED CHANNEL	MODULATION TECHNOLOGY	MODULATION TYPE	DATA RATE (Mbps)
BT-LE	0 to 39	0, 39	DTS	GFSK	1.0
BT-LE	0 to 39	0,19, 39	DTS	GFSK	2.0



**TRANSMITTER UNWANTED EMISSION IN THE OUT-OF-BAND DOMAIN TEST:**

- Pre-Scan has been conducted to determine the worst-case mode from all possible combinations between available modulations, data rates and antenna ports (if EUT with antenna diversity architecture).
- Following channel(s) was (were) selected for the final test as listed below.

MODE	AVAILABLE CHANNEL	TESTED CHANNEL	MODULATION TECHNOLOGY	MODULATION TYPE	DATA RATE (Mbps)
BT-LE	0 to 39	0, 39	DTS	GFSK	1.0
BT-LE	0 to 39	0,19, 39	DTS	GFSK	2.0

**SPURIOUS EMISSIONS TEST (BELOW 1 GHz):**

- Pre-Scan has been conducted to determine the worst-case mode from all possible combinations between available modulations, data rates and antenna ports (if EUT with antenna diversity architecture).
- Following channel(s) was (were) selected for the final test as listed below.

MODE	AVAILABLE CHANNEL	TESTED CHANNEL	MODULATION TECHNOLOGY	MODULATION TYPE	DATA RATE (Mbps)
BT-LE	0 to 39	39	DTS	GFSK	1.0
BT-LE	0 to 39	0,19, 39	DTS	GFSK	2.0
Receiver	-	-	-	-	-

**SPURIOUS EMISSIONS TEST (ABOVE 1 GHz):**

- Pre-Scan has been conducted to determine the worst-case mode from all possible combinations between available modulations, data rates and antenna ports (if EUT with antenna diversity architecture).
- Following channel(s) was (were) selected for the final test as listed below.

MODE	AVAILABLE CHANNEL	TESTED CHANNEL	MODULATION TECHNOLOGY	MODULATION TYPE	DATA RATE (Mbps)
BT-LE	0 to 39	0, 39	DTS	GFSK	1.0
BT-LE	0 to 39	0,19, 39	DTS	GFSK	2.0
Receiver	-	-	-	-	-

**RECEIVER BLOCKING TEST:**

- Following channel(s) was (were) selected for the final test as listed below.

MODE	AVAILABLE CHANNEL	TESTED CHANNEL	MODULATION TECHNOLOGY	MODULATION TYPE	DATA RATE (Mbps)
BT-LE	0 to 39	0, 39	DTS	GFSK	1.0
BT-LE	0 to 39	0,19, 39	DTS	GFSK	2.0



**TEST CONDITION:**

APPLICABLE TO	ENVIRONMENTAL CONDITIONS	INPUT POWER	TESTED BY
ROP	25deg. C, 60%RH	DC 3.3V and DC3.8V from Som test board V05A	Eric Fang
PSD	25deg. C, 60%RH	DC 3.3V and DC3.8V from Som test board V05A	Eric Fang
AD	-	-	-
OCB	25deg. C, 60%RH	DC 3.3V and DC3.8V from Som test board V05A	Eric Fang
OOB	25deg. C, 60%RH	DC 3.3V and DC3.8V from Som test board V05A	Eric Fang
SE<1G	25deg. C, 51%RH	DC 3.3V and DC3.8V from Som test board V05A	hu
SE≥1G	25deg. C, 51%RH	DC 3.3V and DC3.8V from Som test board V05A	hu
RB	25deg. C, 60%RH	DC 3.3V and DC3.8V from Som test board V05A	Eric Fang

**Remarks: The Som test board V05A is support units, it power by 3.8V battery.**



### 2.3. GENERAL DESCRIPTION OF APPLIED STANDARDS

The EUT is a RF product, according to the specifications of the manufacturers. It must comply with the requirements of the following standards:

#### **EN 300 328 V2.2.2 (2019-07)**

All test items have been performed and recorded as per the above standards.

### 2.4. DESCRIPTION OF SUPPORT UNITS

The EUT has been tested as an independent unit together with other necessary accessories or support units. The following support units or accessories were used to form a representative test configuration during the tests.

NO.	PRODUCT	BRAND	MODEL NO.	SERIAL NO.	FCC ID
1	SOM test Board	Particle	V05A	38069A-403-191206	N/A
2	Adapter	N/A	DC5V 2A	N/A	

NO.	SIGNAL CABLE DESCRIPTION OF THE ABOVE SUPPORT UNITS
1	N/A
2	AC Line: Unshielded, Detachable 1.5m, DC Line: Unshielded, Detachable 1.0m



### 3 TEST PROCEDURES AND RESULTS

#### TRANSMITTER PARAMETERS

##### 3.1. RF OUTPUT POWER

###### 3.1.1. LIMITS OF RF OUTPUT POWER

CONDITION	FREQUENCY BAND	LIMIT (e.i.r.p.)
Under all test conditions	2400 ~ 2483.5 MHz	AV: 20dBm

###### 3.1.2. TEST PROCEDURE

Refer to chapter 5.4.2.2 of ETSI EN 300 328 V2.2.2.

Measurement	
<input checked="" type="checkbox"/> Conducted measurement	<input type="checkbox"/> Radiated measurement

###### 3.1.3. DEVIATION FROM TEST STANDARD

No deviation.

###### 3.1.4. TEST SETUP

The measurement was performed at both normal environmental conditions and at the extremes of the operating temperature. The measurement was performed at the lowest, the middle, and the highest channel. The equipment was configured to operate under its worst case situation with respect to output power. (In case of conducted measurements the transmitter shall be connected to the measuring equipment via a suitable attenuator.) Controlling software has been activated to set the EUT on specific channel and power level.



### 3.1.5. TEST RESULTS

TEST CONDITION			EIRP POWER (dBm)		
			(CH0) 2402 MHz	(CH19) 2440 MHz	(CH39) 2480 MHz
<b>BT-LE (GFSK) (1 Mbps)</b>					
T <sub>nom</sub> (°C)	+25	V <sub>nom</sub> (V)	6.75	6.55	6.36
T <sub>min</sub> (°C)	-40		<b>7.33</b>	6.85	6.62
T <sub>max</sub> (°C)	+85		6.34	6.04	6.05

**NOTE:** 1.EIRP = Conducted output power + ANT Gain

TEST CONDITION			EIRP POWER (dBm)		
			(CH0) 2402 MHz	(CH19) 2440 MHz	(CH39) 2480 MHz
<b>BT-LE (GFSK) (2 Mbps)</b>					
T <sub>nom</sub> (°C)	+25	V <sub>nom</sub> (V)	5.04	4.84	4.64
T <sub>min</sub> (°C)	-40		5.46	5.07	5.04
T <sub>max</sub> (°C)	+85		4.78	4.51	4.19

**NOTE:** 1.EIRP = Conducted output power + ANT Gain





### 3.2. POWER SPECTRAL DENSITY

#### 3.2.1. LIMIT OF POWER SPECTRAL DENSITY

CONDITION	FREQUENCY BAND	LIMIT (e.i.r.p.)
Under normal conditions	2400 ~ 2483.5 MHz	10dBm / 1MHz

#### 3.2.2. TEST PROCEDURE

Refer to chapter 5.4.3.2 of ETSI EN 300 328 V2.2.2.

Measurement Method	
<input checked="" type="checkbox"/> Conducted measurement	<input type="checkbox"/> Radiated measurement
<input checked="" type="checkbox"/> Option 1: For equipment with continuous and non-continuous transmissions	
<input type="checkbox"/> Option 2: For equipment with continuous transmission capability or for equipment operating (or with the capability to operate) with a constant duty cycle (e.g. Frame Based equipment)	

#### 3.2.3. DEVIATION FROM TEST STANDARD

No deviation.

#### 3.2.4. TEST SETUP

The measurement was performed at normal environmental conditions only. The measurement was performed at the lowest, the middle, and the highest channel. The equipment was configured to operate under its worst case situation with respect to output power. (In case of conducted measurements the transmitter shall be connected to the measuring equipment via a suitable attenuator.) Controlling software has been activated to set the EUT on specific status.



### 3.2.5. TEST RESULTS

#### BT-LE (GFSK) (1 Mbps)

CHANNEL	CHANNEL FREQUENCY (MHz)	POWER DENSITY (dBm/1MHz) (E.I.R.P)	LIMIT (dBm/1MHz) (E.I.R.P)	PASS/FAIL
0	2402.00	6.68	10	PASS
19	2440.00	6.47	10	PASS
39	2480.00	6.29	10	PASS

#### BT-LE (GFSK) (2 Mbps)

CHANNEL	CHANNEL FREQUENCY (MHz)	POWER DENSITY (dBm/1MHz) (E.I.R.P)	LIMIT (dBm/1MHz) (E.I.R.P)	PASS/FAIL
0	2402.00	3.92	10	PASS
19	2440.00	3.70	10	PASS
39	2480.00	3.48	10	PASS



### 3.3. OCCUPIED CHANNEL BANDWIDTH

#### 3.3.1. LIMIT OF OCCUPIED CHANNEL BANDWIDTH

CONDITION		LIMIT
All types of equipment		Shall fall completely within the band 2400 to 2483.5 MHz.
Additional requirement	For non-adaptive using wide band modulations other than FHSS system and e.i.r.p >10dBm.	Less than 20MHz
	For non-adaptive Frequency Hopping system and e.i.r.p >10dBm.	Less than 5MHz

#### 3.3.2. TEST PROCEDURE

Refer to chapter 5.4.7.2 of ETSI EN 300 328 V2.2.2.

Measurement	
<input checked="" type="checkbox"/> Conducted measurement	<input type="checkbox"/> Radiated measurement

#### 3.3.3. DEVIATION FROM TEST STANDARD

No deviation.

#### 3.3.4. TEST SETUP

The measurement was performed at normal environmental conditions only. This measurement was performed at the lowest and the highest channel. The equipment was configured to operate under its worst case situation with respect to output power. (In case of conducted measurements the transmitter shall be connected to the measuring equipment via a suitable attenuator.) Controlling software has been activated to set the EUT on specific status.



### 3.3.5. TEST RESULTS

#### BT-LE (GFSK) (1 Mbps)

CHANNEL	CHANNEL FREQUENCY (MHz)	OCCUPIED BANDWIDTH (MHz)	Measured frequencies		LIMIT	PASS/FAIL
			FL (MHz)	FH (MHz)		
0	2402	1.06	2401.48	2402.54	FL > 2400 MHz and FH < 2483.5 MHz	PASS
39	2480	1.07	2479.47	2480.54		PASS

Note: FL is the lowest frequency of the 99% occupied bandwidth of power envelope.  
FH is the highest frequency of the 99% occupied bandwidth of power envelope.

#### BT-LE (GFSK) (2 Mbps)

CHANNEL	CHANNEL FREQUENCY (MHz)	OCCUPIED BANDWIDTH (MHz)	Measured frequencies		LIMIT	PASS/FAIL
			FL (MHz)	FH (MHz)		
0	2402	2.08	2400.98	2403.06	FL > 2400 MHz and FH < 2483.5 MHz	PASS
39	2480	2.08	2478.98	2481.06		PASS

Note: FL is the lowest frequency of the 99% occupied bandwidth of power envelope.  
FH is the highest frequency of the 99% occupied bandwidth of power envelope.



### 3.4. TRANSMITTER UNWANTED EMISSIONS IN THE OUT-OF-BAND DOMAIN

#### 3.4.1. LIMITS OF TRANSMITTER UNWANTED EMISSIONS IN THE OUT-OF-BAND DOMAIN

CONDITION	LIMIT
Under all test conditions	The transmitter unwanted emissions in the out-of-band domain but outside the allocated band, shall not exceed the values provided by the mask in below figure.

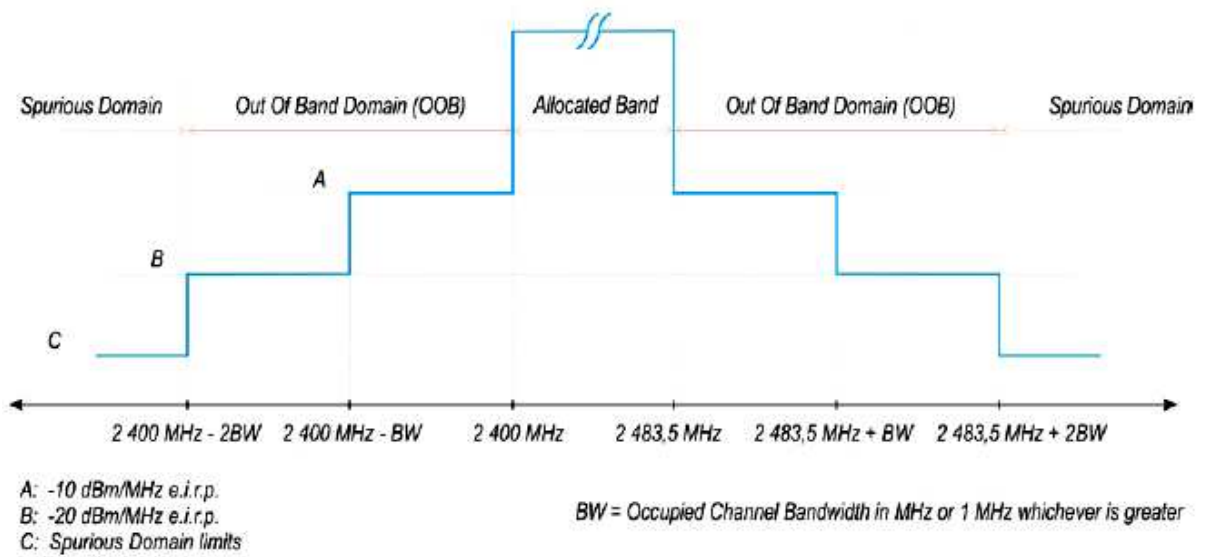

#### 3.4.2. TEST PROCEDURE

Refer to chapter 5.4.8.2 of ETSI EN 300 328 V2.2.2.

Measurement	
<input checked="" type="checkbox"/> Conducted measurement	<input type="checkbox"/> Radiated measurement

#### 3.4.3. DEVIATION FROM TEST STANDARD

No deviation.



### 3.4.4. TEST SETUP

The measurement was performed at normal environmental conditions only. This measurement was performed at the lowest and the highest channel. The equipment was configured to operate under its worst case situation with respect to output power. (In case of conducted measurements the transmitter shall be connected to the measuring equipment via a suitable attenuator.) The frequency has to be recorded for the right and left end above threshold of highest and lowest channel respectively.

### 3.4.5. TEST RESULTS

#### BT-LE (GFSK) (1 Mbps)

CHANNEL FREQ.(MHz)			2402MHz				2480MHz			
TEST CONDITION			OOB Emission (MHz)				OOB Emission (MHz)			
			2398.92 ~ 2400		2397.84 ~ 2398.92		2483.5 ~ 2484.58		2484.58 ~ 2485.66	
Temperature	Voltage		Freq. (MHz)	Power (dBm)	Freq. (MHz)	Power (dBm)	Freq. (MHz)	Power (dBm)	Freq. (MHz)	Power (dBm)
Tnorm(°C)	+25	Normal	2399.50	-42.65	2398.44	-56.13	2484.00	-57.02	2485.06	-59.41
Limit (dBm/MHz)			-10.00		-20.00		-10.00		-20.00	
PASS/FAIL			PASS		PASS		PASS		PASS	

#### BT-LE (GFSK) (2 Mbps)

CHANNEL FREQ.(MHz)			2402MHz				2480MHz			
TEST CONDITION			OOB Emission (MHz)				OOB Emission (MHz)			
			2398.92 ~ 2400		2397.84 ~ 2398.92		2483.5 ~ 2484.58		2484.58 ~ 2485.66	
Temperature	Voltage		Freq. (MHz)	Power (dBm)	Freq. (MHz)	Power (dBm)	Freq. (MHz)	Power (dBm)	Freq. (MHz)	Power (dBm)
Tnorm(°C)	+25	Normal	2399.50	-31.13	2397.42	-54.98	2484.00	-53.52	2486.08	-56.95
Limit (dBm/MHz)			-10.00		-20.00		-10.00		-20.00	
PASS/FAIL			PASS		PASS		PASS		PASS	



### 3.5. TRANSMITTER SPURIOUS EMISSIONS

#### 3.5.1. LIMITS OF TRANSMITTER SPURIOUS EMISSIONS

Transmitter limits for narrowband spurious emissions:

Frequency Range	Maximum Power Limit (e.r.p. (≤ 1 GHz) e.i.r.p. (> 1 GHz))	Bandwidth
30 MHz to 47 MHz	-36dBm	100kHz
47 MHz to 74 MHz	-54dBm	100kHz
74 MHz to 87,5 MHz	-36dBm	100kHz
87,5 MHz to 118 MHz	-54dBm	100kHz
118 MHz to 174 MHz	-36dBm	100kHz
174 MHz to 230 MHz	-54dBm	100kHz
230 MHz to 470 MHz	-36dBm	100kHz
470 MHz to 694 MHz	-54dBm	100kHz
694 MHz to 1 GHz	-36dBm	100kHz
1GHz ~ 12.75GHz	-30dBm	1MHz

Note: These limits are e.r.p. for emissions up to 1 GHz and as e.i.r.p. for emissions above 1 GHz.

#### 3.5.2. TEST PROCEDURE

Refer to chapter 5.4.9.2 of ETSI EN 300 328 V2.2.2.

Measurement	
<input type="checkbox"/> Conducted measurement	<input checked="" type="checkbox"/> Radiated measurement
<p>For Conducted measurement:</p> <p>The level of unwanted emissions shall be measured as their power in a specified load (conducted spurious emissions) and their effective radiated power when radiated by the cabinet or structure of the equipment with the antenna connector(s) terminated by a specified load (cabinet radiation).</p>	
<p>Conducted measurement (For equipment with multiple transmit chains):</p> <p><input type="checkbox"/> Option 1: The results for each of the transmit chains for the corresponding 1MHz segments shall be added and compared with the limits.</p> <p><input type="checkbox"/> Option 2: The results for each of the transmit chains shall be individually compared with the limits after these limits have been reduced by 10 x log (N) (number of active transmit chains)</p>	



**BUREAU  
VERITAS**

**Test Report No.: RE191231N001-2**

### 3.5.3. DEVIATION FROM TEST STANDARD

No deviation.

### 3.5.4. TEST SETUP

1. For the actual test configuration, please refer to the related Item in this test report (Photographs of the Test Configuration).
2. The equipment was configured to operate under its worst case situation with respect to output power.
3. The measurement was performed at normal environmental conditions only. Controlling software has been activated to set the EUT on specific status.
4. This measurement was performed at the lowest and the highest channel.





### 3.5.5. TEST RESULTS

#### BELOW 1GHz WORST-CASE DATA

#### BT\_LE-GFSK (1 Mbps)

<b>FREQUENCY RANGE</b>	30MHz ~ 1GHz	<b>OPERATING CHANNEL</b>	39
------------------------	--------------	--------------------------	----

SPURIOUS EMISSION LEVEL				
Frequency (MHz)	Antenna Polarization	Level (dBm)	Limit (dBm)	Margin (dB)
30.00	H	-83.89	-36.00	-47.89
110.35	H	-95.32	-54.00	-41.32
172.43	H	-90.89	-36.00	-54.89
225.58	H	-85.73	-54.00	-31.73
417.26	H	-80.28	-36.00	-44.28
<b>513.97</b>	<b>H</b>	<b>-76.65</b>	<b>-54.00</b>	<b>-22.65</b>

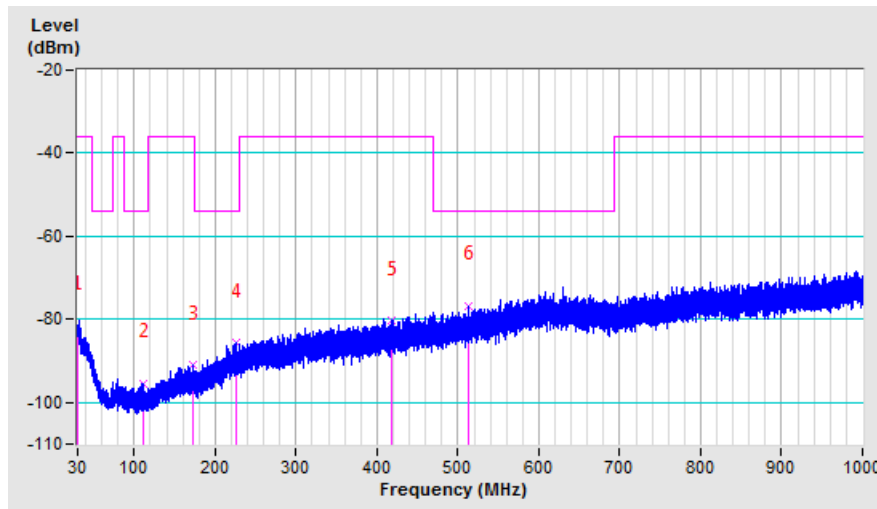



BUREAU VERITAS

Test Report No.: RE191231N001-2

<b>FREQUENCY RANGE</b>	30MHz ~ 1GHz	<b>OPERATING CHANNEL</b>	39
------------------------	--------------	--------------------------	----

SPURIOUS EMISSION LEVEL				
Frequency (MHz)	Antenna Polarization	Level (dBm)	Limit (dBm)	Margin (dB)
30.00	V	-93.10	-36.00	-57.10
110.12	V	-83.45	-54.00	-29.45
153.29	V	-87.16	-36.00	-51.16
215.85	V	-86.80	-54.00	-32.80
266.52	V	-85.15	-36.00	-49.15
305.97	V	-81.69	-36.00	-45.69

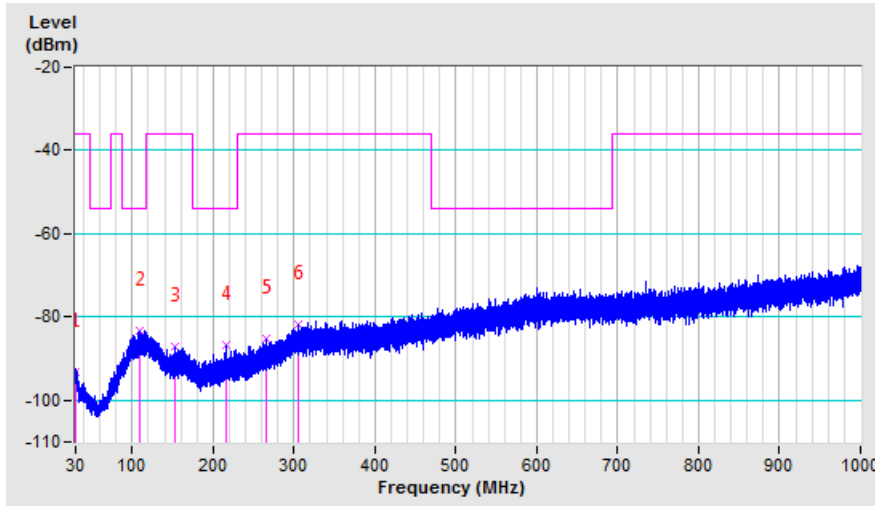



BUREAU VERITAS

Test Report No.: RE191231N001-2

BT\_LE-GFSK (2 Mbps)

FREQUENCY RANGE	30MHz ~ 1GHz	OPERATING CHANNEL	39
-----------------	--------------	-------------------	----

SPURIOUS EMISSION LEVEL				
Frequency (MHz)	Antenna Polarization	Level (dBm)	Limit (dBm)	Margin (dB)
30.00	H	-82.34	-36.00	-46.34
256.14	H	-83.53	-36.00	-47.53
307.84	H	-82.54	-36.00	-46.54
375.55	H	-80.58	-36.00	-44.58
435.36	H	-78.31	-36.00	-42.31
531.68	H	-77.04	-54.00	-23.04

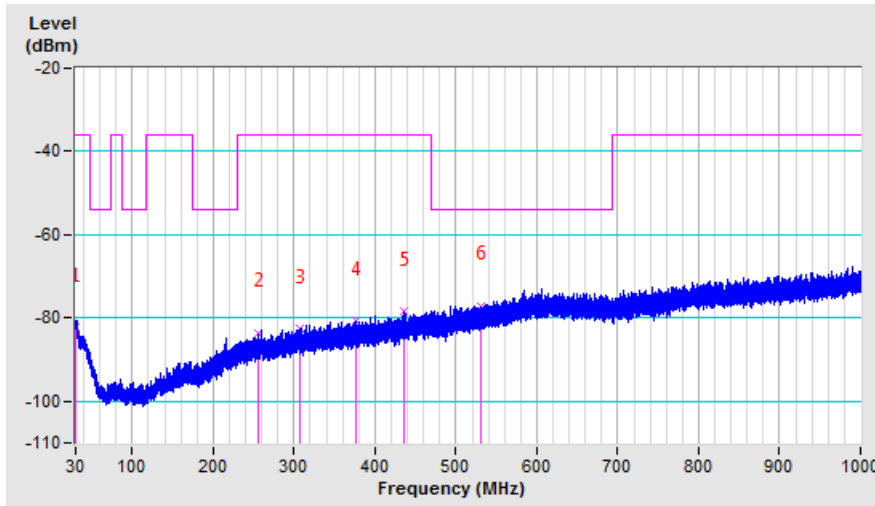



BUREAU VERITAS

Test Report No.: RE191231N001-2

FREQUENCY RANGE	30MHz ~ 1GHz	OPERATING CHANNEL	39
-----------------	--------------	-------------------	----

SPURIOUS EMISSION LEVEL				
Frequency (MHz)	Antenna Polarization	Level (dBm)	Limit (dBm)	Margin (dB)
30.00	V	-95.40	-36.00	-59.40
96.90	V	-85.24	-54.00	-31.24
130.91	V	-84.44	-36.00	-48.44
310.43	V	-80.75	-36.00	-44.75
433.07	V	-78.69	-36.00	-42.69
528.87	V	-76.73	-54.00	-22.73

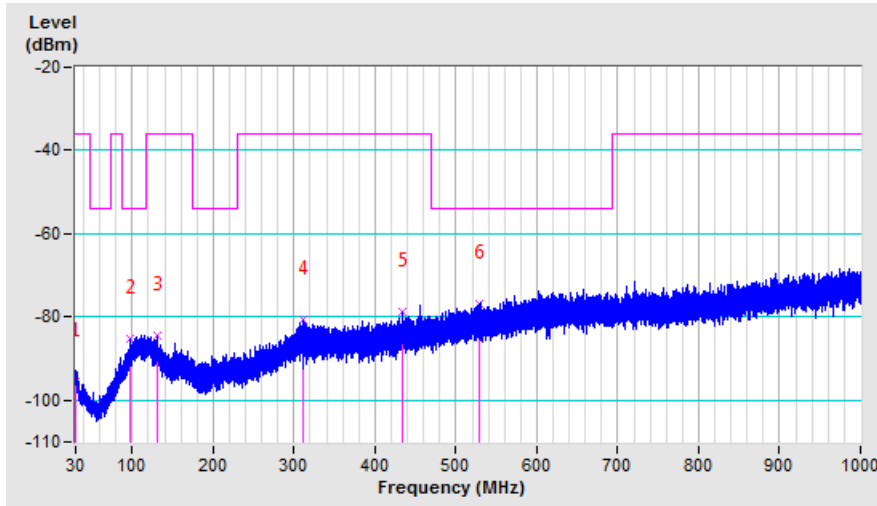



ABOVE 1GHz WORST-CASE DATA

BT\_LE-GFSK (1 Mbps)

<b>FREQUENCY RANGE</b>	1GHz ~ 12.75GHz	<b>OPERATING CHANNEL</b>	0, 39
------------------------	-----------------	--------------------------	-------

SPURIOUS EMISSION LEVEL					
Channel	Frequency (MHz)	Antenna Polarization	Level (dBm)	Limit (dBm)	Margin (dB)
0	4804.00	H	-55.47	-30.00	-25.47
	4804.00	V	-54.45	-30.00	-24.45
	7206.00	H	-52.96	-30.00	-22.96
	7206.00	V	-51.85	-30.00	-21.85
39	4960.00	H	-55.24	-30.00	-25.24
	4960.00	V	-55.61	-30.00	-25.61
	7440.00	H	-51.15	-30.00	-21.15
	7440.00	V	-51.76	-30.00	-21.76

BT\_LE-GFSK (2 Mbps)

<b>FREQUENCY RANGE</b>	1GHz ~ 12.75GHz	<b>OPERATING CHANNEL</b>	0, 39
------------------------	-----------------	--------------------------	-------

SPURIOUS EMISSION LEVEL					
Channel	Frequency (MHz)	Antenna Polarization	Level (dBm)	Limit (dBm)	Margin (dB)
0	4804.00	H	-56.17	-30.00	-26.17
	4804.00	V	-55.99	-30.00	-25.99
	7206.00	H	-53.35	-30.00	-23.35
	7206.00	V	-51.08	-30.00	-21.08
39	4960.00	H	-55.47	-30.00	-25.47
	4960.00	V	-55.36	-30.00	-25.36
	7440.00	H	-50.55	-30.00	-20.55
	7440.00	V	-52.19	-30.00	-22.19



### RECEIVER PARAMETERS

#### 3.6. RECEIVER SPURIOUS RADIATION

##### 3.6.1. LIMITS OF RECEIVER SPURIOUS RADIATION

Frequency Range	Maximum Power Limit (e.r.p. (≤ 1 GHz) e.i.r.p. (> 1 GHz))
30MHz ~ 1GHz	-57dBm
1GHz ~ 12.75GHz	-47dBm

Note: These limits are e.r.p. for emissions up to 1 GHz and as e.i.r.p. for emissions above 1 GHz.

##### 3.6.2. TEST PROCEDURE

Refer to chapter 5.4.10.2 of ETSI EN 300 328 V2.2.2.

Measurement	
<input type="checkbox"/> Conducted measurement	<input checked="" type="checkbox"/> Radiated measurement
<u>For Conducted measurement:</u> The level of unwanted emissions shall be measured as their power in a specified load (conducted spurious emissions) and their effective radiated power when radiated by the cabinet or structure of the equipment with the antenna connector(s) terminated by a specified load (cabinet radiation).	
<u>Conducted measurement (For equipment with multiple transmit chains):</u> <input type="checkbox"/> Option 1: The results for each of the transmit chains for the corresponding 1MHz segments shall be added and compared with the limits. <input type="checkbox"/> Option 2: The results for each of the transmit chains shall be individually compared with the limits after these limits have been reduced by 10 x log (N) (number of active transmit chains)	

##### 3.6.3. DEVIATION FROM TEST STANDARD

No deviation.

##### 3.6.4. TEST SETUP

1. For the actual test configuration, please refer to the related Item in this test report (Photographs of the Test Configuration).
2. Testing was performed when the equipment was in a receive-only mode.
3. The measurement was performed at normal environmental conditions only. Controlling software has been activated to set the EUT on specific status.
4. This measurement was performed at the lowest and the highest channel.



### 3.6.5. TEST RESULTS

#### RX WORST-CASE DATA

#### BT\_LE-GFSK (1 Mbps)

<b>FREQUENCY RANGE</b>	30MHz ~ 1GHz	<b>OPERATING CHANNEL</b>	39
------------------------	--------------	--------------------------	----

SPURIOUS EMISSION LEVEL				
Frequency (MHz)	Antenna Polarization	Level (dBm)	Limit (dBm)	Margin (dB)
30.00	H	-82.18	-57.00	-25.18
154.26	H	-92.09	-57.00	-35.09
215.01	H	-86.80	-57.00	-29.80
279.55	H	-82.49	-57.00	-25.49
355.01	H	-81.08	-57.00	-24.08
<b>423.27</b>	<b>H</b>	<b>-78.69</b>	<b>-57.00</b>	<b>-21.69</b>

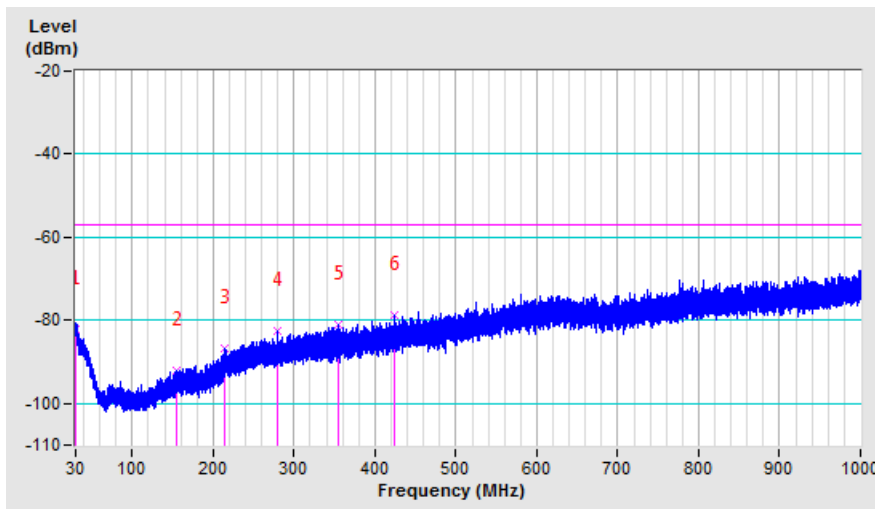



BUREAU VERITAS

Test Report No.: RE191231N001-2

<b>FREQUENCY RANGE</b>	30MHz ~ 1GHz	<b>OPERATING CHANNEL</b>	39
------------------------	--------------	--------------------------	----

SPURIOUS EMISSION LEVEL				
Frequency (MHz)	Antenna Polarization	Level (dBm)	Limit (dBm)	Margin (dB)
30.00	V	-92.37	-57.00	-35.37
108.70	V	-82.35	-57.00	-25.35
216.05	V	-86.66	-57.00	-29.66
272.82	V	-85.27	-57.00	-28.27
342.24	V	-79.40	-57.00	-22.40
387.90	V	-79.41	-57.00	-22.41

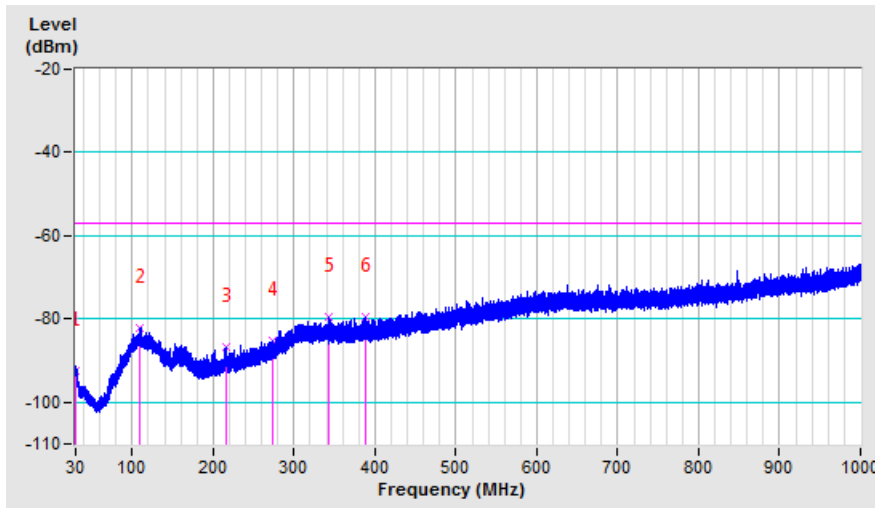





BUREAU VERITAS

Test Report No.: RE191231N001-2

BT\_LE-GFSK (2 Mbps)

FREQUENCY RANGE	30MHz ~ 1GHz	OPERATING CHANNEL	39
-----------------	--------------	-------------------	----

SPURIOUS EMISSION LEVEL				
Frequency (MHz)	Antenna Polarization	Level (dBm)	Limit (dBm)	Margin (dB)
30.00	H	-81.06	-57.00	-24.06
130.14	H	-93.69	-57.00	-36.69
214.88	H	-86.08	-57.00	-29.08
260.73	H	-83.04	-57.00	-26.04
316.34	H	-81.57	-57.00	-24.57
374.61	H	-80.83	-57.00	-23.83

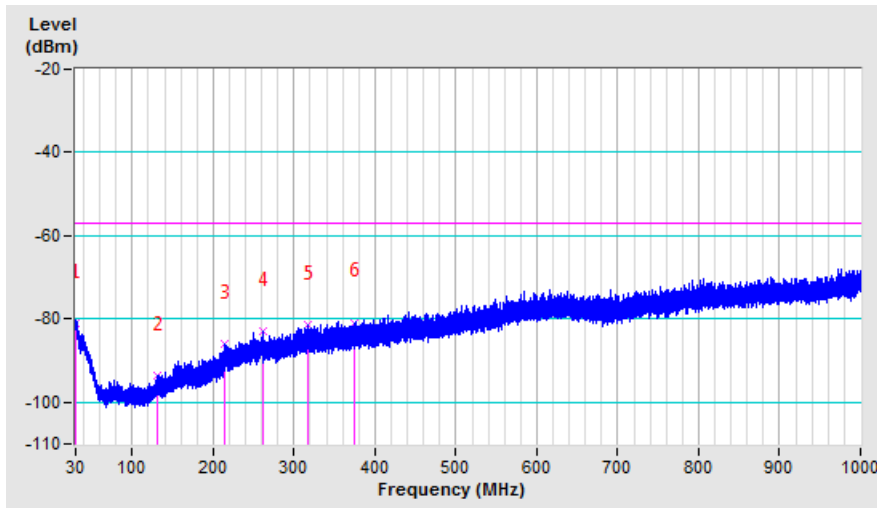



**BUREAU  
VERITAS**

Test Report No.: RE191231N001-2

<b>FREQUENCY RANGE</b>	30MHz ~ 1GHz	<b>OPERATING CHANNEL</b>	39
------------------------	--------------	--------------------------	----

SPURIOUS EMISSION LEVEL				
Frequency (MHz)	Antenna Polarization	Level (dBm)	Limit (dBm)	Margin (dB)
30.00	V	-94.76	-57.00	-37.76
117.46	V	-82.93	-57.00	-25.93
166.22	V	-86.34	-57.00	-29.34
268.72	V	-85.56	-57.00	-28.56
304.93	V	-81.28	-57.00	-24.28
373.61	V	-80.93	-57.00	-23.93

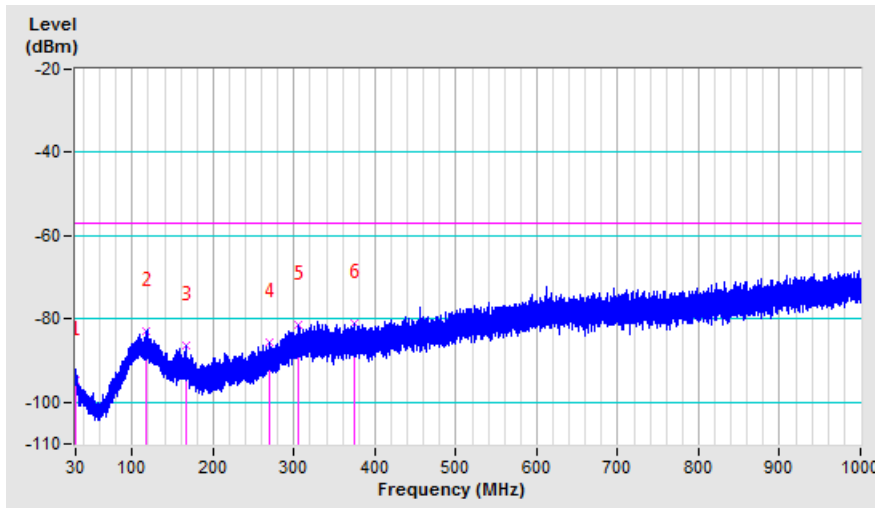



RX ABOVE 1GHz DATA

BT\_LE-GFSK (1 Mbps)

<b>SPURIOUS EMISSION FREQUENCY RANGE</b>	1GHz ~ 12.75GHz	<b>OPERATING CHANNEL</b>	0, 39
--	-----------------	--------------------------	-------

SPURIOUS EMISSION LEVEL					
Channel	Frequency (MHz)	Antenna Polarization	Level (dBm)	Limit (dBm)	Margin (dB)
0	4804.00	H	-52.36	-47.00	-5.36
	4804.00	V	-52.96	-47.00	-5.96
	7206.00	H	-52.14	-47.00	-5.14
	7206.00	V	-53.26	-47.00	-6.26
39	4960.00	H	-52.02	-47.00	-5.02
	4960.00	V	-52.88	-47.00	-5.88
	<b>7440.00</b>	<b>H</b>	<b>-51.86</b>	<b>-47.00</b>	<b>-4.86</b>
	7440.00	V	-52.46	-47.00	-5.46

BT\_LE-GFSK (2 Mbps)

<b>SPURIOUS EMISSION FREQUENCY RANGE</b>	1GHz ~ 12.75GHz	<b>OPERATING CHANNEL</b>	0, 39
--	-----------------	--------------------------	-------

SPURIOUS EMISSION LEVEL					
Channel	Frequency (MHz)	Antenna Polarization	Level (dBm)	Limit (dBm)	Margin (dB)
0	4804.00	H	-52.63	-47.00	-5.63
	4804.00	V	-53.26	-47.00	-6.26
	7206.00	H	-52.99	-47.00	-5.99
	7206.00	V	-53.64	-47.00	-6.64
39	4960.00	H	-52.26	-47.00	-5.26
	4960.00	V	-53.12	-47.00	-6.12
	7440.00	H	-52.76	-47.00	-5.76
	7440.00	V	-52.38	-47.00	-5.38



### 3.7. RECEIVER BLOCKING

#### 3.7.1. LIMITS OF RECEIVER BLOCKING

This requirement applies to all receiver categories.

Receiver Category		
<input type="checkbox"/> Category 1(EIRP>10dBm)	<input checked="" type="checkbox"/> Category 2(EIRP ≤ 10dBm)	<input type="checkbox"/> Category 3(EIRP ≤ 0dBm)
Minimum performance criterion	<input checked="" type="checkbox"/> PER ≤ 10%	
	<input type="checkbox"/> Alternative performance criteria (See note)	
Note: The manufacturer was declared the minimum performance criterion shall be no loss of the wireless transmission function needed for the intended use of the equipment.		

Receiver Category 1 Equipment			
Wanted signal mean power from companion device (dBm)(See note 1 and 4)	Blocking Signal Frequency (MHz)	Blocking Signal Power (dBm) (See note 4)	Type of blocking signal
(-133dBm+10xlog <sub>10</sub> (OCBW) Or -68dBm whichever is less (See note 2)	2 380	-34	CW
	2 504		
(-139dBm+10xlog <sub>10</sub> (OCBW) Or -74dBm whichever is less (See note 3)	2 300		
	2 330		
	2 360		
	2 524		
	2 584		
	2 674		
<p>NOTE 1: OCBW is in Hz.</p> <p>NOTE 2: In case of radiated measurements using a companion device and the level of the wanted signal from the companion device cannot be determined, a relative test may be performed using a wanted signal up to P<sub>min</sub> + 26 dB where P<sub>min</sub> is the minimum level of wanted signal required to meet the minimum performance criteria as defined in clause 4.3.1.12.3 in the absence of any blocking signal.</p> <p>NOTE 3: In case of radiated measurements using a companion device and the level of the wanted signal from the companion device cannot be determined, a relative test may be performed using a wanted signal up to P<sub>min</sub> + 20 dB where P<sub>min</sub> is the minimum level of wanted signal required to meet the minimum performance criteria as defined in clause 4.3.1.12.3 in the absence of any blocking signal.</p> <p>NOTE 4: The level specified is the level at the UUT receiver input assuming a 0 dBi antenna assembly gain. In case of conducted measurements, this level has to be corrected for the (in-band) antenna assembly gain (G). In case of radiated measurements, this level is equivalent to a power flux density (PFD) in front of the UUT antenna with the UUT being configured/positioned as recorded in clause 5.4.3.2.2.</p>			



Receiver Category 2 Equipment			
Wanted signal mean power from companion device (dBm)(See note 1 and 3)	Blocking Signal Frequency (MHz)	Blocking Signal Power (dBm) (See note 3)	Type of blocking signal
(-139dBm+10xlog <sub>10</sub> (OCBW)+10dB) Or -74dBm+10dB whichever is less(See note 2)	2 380	-34	CW
	2 504		
	2 300		
	2 584		
NOTE 1: OCBW is in Hz. NOTE 2: In case of radiated measurements using a companion device and the level of the wanted signal from the companion device cannot be determined, a relative test may be performed using a wanted signal up to P <sub>min</sub> + 26 dB where P <sub>min</sub> is the minimum level of wanted signal required to meet the minimum performance criteria as defined in clause 4.3.1.12.3 in the absence of any blocking signal. NOTE 3: The level specified is the level at the UUT receiver input assuming a 0 dBi antenna assembly gain. In case of conducted measurements, this level has to be corrected for the (in-band) antenna assembly gain (G). In case of radiated measurements, this level is equivalent to a power flux density (PFD) in front of the UUT antenna with the UUT being configured/positioned as recorded in clause 5.4.3.2.2.			

Receiver Category 3 Equipment			
Wanted signal mean power from companion device (dBm) (See note 1 and 3)	Blocking Signal Frequency (MHz)	Blocking Signal Power (dBm) (See note 3)	Type of blocking signal
(-139dBm+10xlog <sub>10</sub> (OCBW)+20dB) Or -74dBm+20dB whichever is less(See note 2)	2 380	-34	CW
	2 504		
	2 300		
	2 584		
NOTE 1: OCBW is in Hz. NOTE 2: In case of radiated measurements using a companion device and the level of the wanted signal from the companion device cannot be determined, a relative the test may be performed using a wanted signal up to P <sub>min</sub> + 30 dB where P <sub>min</sub> is the minimum level of wanted signal required to meet the minimum performance criteria as defined in clause 4.3.1.12.3 in the absence of any blocking signal. NOTE 3: The level specified is the level at the UUT receiver input assuming a 0 dBi antenna assembly gain. In case of conducted measurements, this level has to be corrected for the (in-band) antenna assembly gain (G). In case of radiated measurements, this level is equivalent to a power flux density (PFD) in front of the UUT antenna with the UUT being configured/positioned as recorded in clause 5.4.3.2.2.			

### 3.7.2. TEST PROCEDURE

Refer to chapter 5.4.11.2. of ETSI EN 300 328 V2.2.2.

Measurement	
<input checked="" type="checkbox"/> Conducted measurement	<input type="checkbox"/> Radiated measurement

### 3.7.3. DEVIATION FROM TEST STANDARD

No deviation.



### 3.7.4. TEST SETUP CONFIGURATION

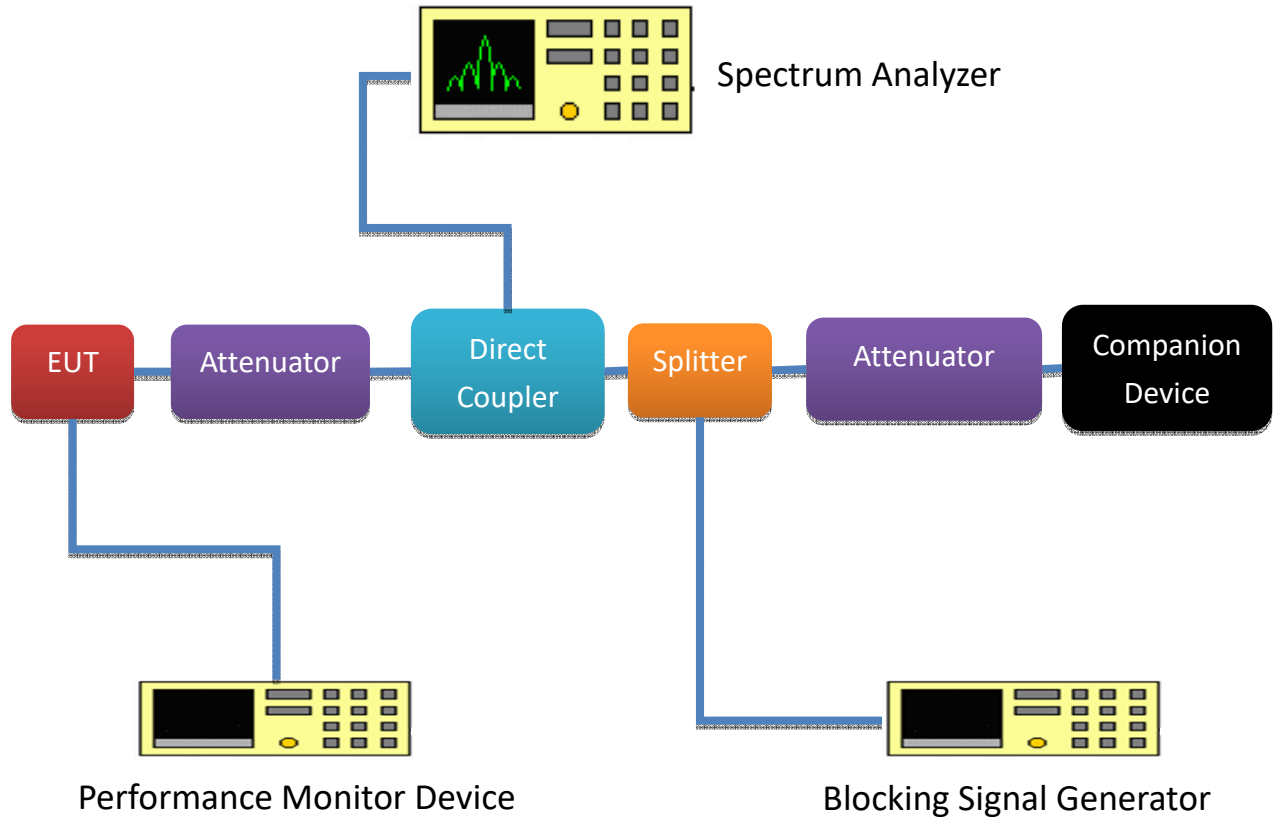



### 3.7.5. TEST RESULT

#### BTLE: (1 Mbps)

#### Receiver Category 2 Equipment

Receiver blocking performance when operating at the lowest operating channel(CH0)				
OCBW <sub>min</sub> : 1.06MHz		antenna gain(G) : 2 dBi		
The actual blocking signal power(Note1)		<input checked="" type="checkbox"/> at the antenna connector		
		<input type="checkbox"/> in front of the antenna		
Note1: For the conducted measurements , the level shall be corrected as follows: the actual blocking signal power = blocking signal power + antenna gain				
Wanted signal mean power from companion device (dBm)	Blocking signal frequency (MHz)	The actual blocking signal power (dBm)	PER(%)	Pass/Fail
-68.75	2300	-32	0	PASS
	2380		0	PASS

Receiver blocking performance when operating at the Highest operating channel(CH39)				
OCBW <sub>min</sub> : 1.07MHz		antenna gain(G) : 2 dBi		
The actual blocking signal power(Note1)		<input checked="" type="checkbox"/> at the antenna connector		
		<input type="checkbox"/> in front of the antenna		
Note1: For the conducted measurements , the level shall be corrected as follows: the actual blocking signal power = blocking signal power + antenna gain				
Wanted signal mean power from companion device (dBm)	Blocking signal frequency (MHz)	The actual blocking signal power (dBm)	PER(%)	Pass/Fail
-68.71	2504	-32	0	PASS
	2584		0	PASS



BTLE: (2 Mbps)

Receiver Category 2 Equipment

Receiver blocking performance when operating at the lowest operating channel(CH0)				
OCBW <sub>min</sub> : 2.08MHz			antenna gain(G) : 2 dBi	
The actual blocking signal power(Note1)			<input checked="" type="checkbox"/> at the antenna connector	
			<input type="checkbox"/> in front of the antenna	
Note1: For the conducted measurements , the level shall be corrected as follows: the actual blocking signal power = blocking signal power + antenna gain				
Wanted signal mean power from companion device (dBm)	Blocking signal frequency (MHz)	The actual blocking signal power (dBm)	PER(%)	Pass/Fail
-65.82	2300	-32	0	PASS
	2380		0	PASS

Receiver blocking performance when operating at the Highest operating channel(CH39)				
OCBW <sub>min</sub> : 2.08MHz			antenna gain(G) : 2 dBi	
The actual blocking signal power(Note1)			<input checked="" type="checkbox"/> at the antenna connector	
			<input type="checkbox"/> in front of the antenna	
Note1: For the conducted measurements , the level shall be corrected as follows: the actual blocking signal power = blocking signal power + antenna gain				
Wanted signal mean power from companion device (dBm)	Blocking signal frequency (MHz)	The actual blocking signal power (dBm)	PER(%)	Pass/Fail
-65.82	2504	-32	0	PASS
	2584		0.4	PASS





## 4 PHOTOGRAPHS OF THE TEST CONFIGURATION

SPURIOUS EMISSION TEST BELOW 1GHz



SPURIOUS EMISSION TEST ABOVE 1GHz





## RECEIVING BLOCKING





**BUREAU  
VERITAS**

Test Report No.: RE191231N001-2

## **5 APPENDIX A – MODIFICATIONS RECORDERS FOR ENGINEERING CHANGES TO THE EUT BY THE LAB**

No any modifications were made to the EUT by the lab during the test.

**--- END ---**