

TEST REPORT



Applicant	Particle Industries, Inc
Address	126 Post St, 4th floor, San Francisco, CA 94108 USA

Manufacturer or Supplier	Particle Industries, Inc	
Address	126 Post St, 4th floor, San Francisco, CA 94108 USA	
Product	Boron 2G/3G	
Brand Name	Particle Industries, Inc	
Model	BRN310	
Additional Model & Model Difference	N/A	
Date of tests	Sep. 03, 2018 ~ Nov. 08, 2018	

The submitted sample of the above equipment has been tested according to the requirements of the following standard:

EN 300 328 V2.1.1 (2016-11)

CONCLUSION: The submitted sample was found to COMPLY with the test requirement

Tested by Breeze Jiang Project Engineer / EMC Department	Approved by Glyn He Supervisor / EMC Department
	
Date: Dec. 10, 2018	

This report is governed by, and incorporates by reference, CPS Conditions of Service as posted at the date of issuance of this report at <http://www.bureauveritas.com/home/about-us/our-business/cps/about-us/terms-conditions> and is intended for your exclusive use. Any copying or replication of this report to or for any other person or entity, or use of our name or trademark, is permitted only with our prior written permission. This report sets forth our findings solely with respect to the test samples identified herein. The results set forth in this report are not indicative or representative of the quality or characteristics of the lot from which a test sample was taken or any similar or identical product unless specifically and expressly noted. Our report includes all of the tests requested by you and the results thereof based upon the information that you provided to us. Measurement uncertainty is only provided upon request for accredited tests. You have 60 days from date of issuance of this report to notify us of any material error or omission caused by our negligence or if you require measurement uncertainty; provided, however, that such notice shall be in writing and shall specifically address the issue you wish to raise. A failure to raise such issue within the prescribed time shall constitute your unqualified acceptance of the completeness of this report, the tests conducted and the correctness of the report contents.

TABLE OF CONTENTS

RELEASE CONTROL RECORD	4
1. SUMMARY OF TEST RESULTS	5
1.1. TEST INSTRUMENTS	6
1.2. MEASUREMENT UNCERTAINTY	8
1.3. MAXIMUM MEASUREMENT UNCERTAINTY	8
2. GENERAL INFORMATION.....	9
2.1. GENERAL DESCRIPTION OF EUT.....	9
2.2. DESCRIPTION OF TEST MODES.....	10
2.2.1. TEST MODE APPLICABILITY AND TESTED CHANNEL DETAIL.....	11
2.3. GENERAL DESCRIPTION OF APPLIED STANDARDS	14
2.4. DESCRIPTION OF SUPPORT UNITS.....	14
3 TEST PROCEDURES AND RESULTS	15
TRANSMITTER PARAMETERS	15
3.1. RF OUTPUT POWER	15
3.1.1 LIMITS OF RF OUTPUT POWER	15
3.1.2 TEST PROCEDURE.....	15
3.1.3 DEVIATION FROM TEST STANDARD	15
3.1.4 TEST SETUP.....	15
3.1.5 TEST RESULTS	16
3.2. POWER SPECTRAL DENSITY	17
3.2.1 LIMIT OF POWER SPECTRAL DENSITY	17
3.2.2 TEST PROCEDURE.....	17
3.2.3 DEVIATION FROM TEST STANDARD	17
3.2.4 TEST SETUP.....	17
3.2.5 TEST RESULTS	18
3.3. OCCUPIED CHANNEL BANDWIDTH	19
3.3.1 LIMIT OF OCCUPIED CHANNEL BANDWIDTH.....	19
3.3.2 TEST PROCEDURE.....	19
3.3.3 DEVIATION FROM TEST STANDARD	19
3.3.4 TEST SETUP.....	19
3.3.5 TEST RESULTS	20
3.4. TRANSMITTER UNWANTED EMISSIONS IN THE OUT-OF-BAND DOMAIN	21
3.4.1 LIMITS OF TRANSMITTER UNWANTED EMISSIONS IN THE OUT-OF-BAND DOMAIN	21
3.4.2 TEST PROCEDURE.....	21
3.4.3 DEVIATION FROM TEST STANDARD	21
3.4.4 TEST SETUP.....	22
3.4.5 TEST RESULTS	22
3.5. TRANSMITTER SPURIOUS EMISSIONS.....	23
3.5.1 LIMITS OF TRANSMITTER SPURIOUS EMISSIONS.....	23
3.5.2 TEST PROCEDURE.....	23
3.5.3 DEVIATION FROM TEST STANDARD	24
3.5.4 TEST SETUP.....	24
3.5.5 TEST RESULTS	25
RECEIVER PARAMETERS	28
3.6. RECEIVER SPURIOUS RADIATION.....	28
3.6.1 LIMITS OF RECEIVER SPURIOUS RADIATION	28
3.6.2 TEST PROCEDURE.....	28



3.6.3	DEVIATION FROM TEST STANDARD	28
3.6.4	TEST SETUP	28
3.6.5	TEST RESULTS	29
3.7.	RECEIVER BLOCKING	32
3.7.1.	LIMITS OF RECEIVER BLOCKING	32
3.7.2.	TEST PROCEDURE	33
3.7.3.	DEVIATION FROM TEST STANDARD	33
3.7.4.	TEST SETUP CONFIGURATION	34
3.7.5.	TEST RESULT	35
4	PHOTOGRAPHS OF THE TEST CONFIGURATION	36
5	APPENDIX A – MODIFICATIONS RECORDERS FOR ENGINEERING CHANGES TO THE EUT BY THE LAB	38



Test Report No.: RE180831N010-1

RELEASE CONTROL RECORD

ISSUE NO.	REASON FOR CHANGE	DATE ISSUED
RE180831N010-1	Original release	Dec. 10, 2018

1. SUMMARY OF TEST RESULTS

The EUT has been tested according to the following specifications:

EN 300 328 V2.1.1		
Clause	Test Parameter	Results
	TRANSMITTER PARAMETERS	
4.3.2.2	RF Output Power	Pass
4.3.2.3	Power Spectral Density	Pass
4.3.1.3	Duty cycle, Tx-sequence, Tx-gap (Non-adaptive equipment)	Not Applicable
4.3.1.6	Medium Utilisation (Non-Adaptive Equipment)	Not Applicable
4.3.2.6	Adaptivity	Not Applicable (Note)
4.3.2.7	Occupied Channel Bandwidth	Pass
4.3.2.8	Transmitter unwanted emission in the OOB domain	Pass
4.3.2.9	Transmitter unwanted emissions in the spurious domain	Pass
	RECEIVER PARAMETERS	
4.3.2.10	Receiver Spurious Emissions	Pass
4.3.2.11	Receiver Blocking	Pass

Note: These requirements do not apply for equipment with a maximum declared RF Output power of less than 10 dBm EIRP or for equipment when operating in a mode where the RF Output power is less than 10 dBm EIRP.

1.1. TEST INSTRUMENTS

Equipment	Manufacturer	Model No.	Serial No.	Last Cal.	Next Cal.
EMI Test Receiver	Rohde&Schwarz	ESU40	100449	Mar. 21,18	Mar. 20,19
Signal and Spectrum Analyzer	Rohde&Schwarz	FSV40	101094	Mar. 21,18	Mar. 20,19
Bilog Antenna	Teseq	CBL 6111D	30643	Aug. 11, 18	Aug. 10, 19
Horn Antenna	ETS-Lindgren	3117	00062558	Jul. 21, 18	Jul. 20, 19
GPS Generator+ Antenna	TOJOIN	GNSS-5000A	E1-010119	Sep. 08,18	Sep. 07,19
3m Semi-anechoic Chamber	ETS-LINDGREN	9m*6m*6m	NSEMC003	Feb. 10,18	Feb. 09,19
Test Software	ADT	ADT_Radiated_V7.6.15.9.2	N/A	N/A	N/A
Horn Antenna (15GHz-40GHz)	SCHWARZBECK	BBHA 9170	BBHA9170147	May 05,18	May 04,19
Amplifier	Burgeon	BPA-530	100220	Apr. 18,18	Apr. 18,19
Broadband Preamplifier (1GHz~18GHz)	SCHWARZBECK	BBV9718	305	Apr. 18,18	Apr. 18,19
Pre-Amplifier (18GHz-40GHz)	EMCI	EMC 184045	980102	Nov. 08,18	Nov. 07,19
Power Sensor	Keysight	U2021XA	MY55060016	Jun. 13,18	Jun. 12,19
Power Sensor	Keysight	U2021XA	MY55060018	Jun. 13,18	Jun. 12,19
Digital Multimeter	FLUKE	15B	A1220010DG	Oct. 21, 18	Oct.20, 19
Humid & Temp Programmable Tester	Haida	HD-2257	110807201	Sep.05, 18	Sep. 04,19
Oscilloscope	Agilent	DSO9254A	MY51260160	Nov. 08,18	Nov. 07,19
Signal and Spectrum Analyzer	Rohde&Schwarz	FSV7	102331	Nov. 04,18	Nov. 03,19
Spectrum Analyzer	Keysight	N9020A	MY55400499	Mar. 21,18	Mar. 20,19
Signal Generator	Agilent	N5183A	MY50140980	Jan. 02,18	Jan. 01,19
MXG-B RF Vector Signal Generator	Keysight	N5182B	MY56200288	Jan. 02,18	Jan. 01,19
Wireless Connectivity Tester	Rohde&Schwarz	CMW270	100908	Jan. 10, 18	Jan. 09, 19
Vector Signal Generator	Rohde&Schwarz	SMBV100A	257199	Jun. 13,18	Jun. 12,19
Attenuator	MINI	BW-S10W2+	S130129FGE2	N/A	N/A

NOTE:

1. The test was performed in 966 Chamber and RF Oven room.
2. The calibration interval of the above test instruments is 12 months and the calibrations are traceable to CEPREI/CHINA, GRGT/CHINA and NIM/CHINA.
3. The horn antenna is used only for the measurement of emission frequency above 1GHz if tested.



For Receiver Blocking test and Adaptivity test:

Equipment	Manufacturer	Model No.	Serial No.	Last Cal.	Next Cal.
Wireless Connectivity Tester	Rohde&Schwarz	CMW270	100908	Jan. 10, 18	Jan. 09, 19
Test software	TonScend	JS1120-3-1	JS-001	N/A	N/A
Spectrum Analyzer	Keysight	N9020A	MY55400499	Mar. 21,18	Mar. 20,19
Signal Generator	Agilent	N5183A	MY50140980	Jan. 02,18	Jan. 01,19
MXG-B RF Vector Signal Generator	Keysight	N5182B	MY56200288	Jan. 02,18	Jan. 01,19

NOTE:

1. The test was performed in RF Oven room.
2. The calibration interval of the above test instruments is 12 months and the calibrations are traceable to CEPREI/CHINA, GRGT/CHINA and NIM/CHINA.

1.2. MEASUREMENT UNCERTAINTY

Where relevant, the following measurement uncertainty levels have been estimated for tests performed on the EUT:

This uncertainty represents an expanded uncertainty expressed at approximately the 95% confidence level using a coverage factor of k=2.

Parameter	Uncertainty
Occupied Channel Bandwidth	±1.132 %
RF output power, conducted	±0.56dB
Power Spectral Density, conducted	±1.017dB
Unwanted Emissions, conducted	±1.017dB
All emissions, radiated	±4.84dB
Temperature	±0.23°C
Supply voltages	±0.1 %
Time	±4 %

1.3. MAXIMUM MEASUREMENT UNCERTAINTY

For the test methods, according to ETSI EN 300 328 standard, the measurement uncertainty figures shall be calculated in accordance with ETR 100 028-1 [4] and shall correspond to an expansion factor (coverage factor) k = 1,96 or k = 2 (which provide confidence levels of respectively 95 % and 95,45 % in the case where the distributions characterizing the actual measurement uncertainties are normal (Gaussian)).

Maximum measurement uncertainty

Parameter	Uncertainty
Occupied Channel Bandwidth	±5 %
RF output power, conducted	±1,5 dB
Power Spectral Density, conducted	±3 dB
Unwanted Emissions, conducted	±3 dB
All emissions, radiated	±6 dB
Temperature	±3 °C
Supply voltages	±3 %
Time	±5 %

2. GENERAL INFORMATION

2.1. GENERAL DESCRIPTION OF EUT

PRODUCT	Boron 2G/3G
TEST MODEL	BRN310
ADDITIONALMODEL	N/A
NOMINAL VOLTAGE	Li+ PIN /Battery connector: DC 3.7V from Li-ion Battery or VUSB PIN /USB connector :DC 5V from USB Host Unit
OPERATING TEMPERATURE RNAGE	-20 ~ +80°C
MODULATION TECHNOLOGY	DSSS(IEEE 802.15.4)
MODULATION TYPE	OQPSK
OPERATING FREQUENCY	2405-2480MHz
ADPTIVE/NON-ADPTIVE	<input type="checkbox"/> non-adaptive Equipment <input checked="" type="checkbox"/> adaptive Equipment without the possibility to switch to a non-adaptive mode <input type="checkbox"/> adaptive Equipment which can also operate in a non-adaptive mode
EIRP	-0.77dBm (Measured Max.)
ANTENNA TYPE	PCB Antenna, 0dBi Gain
I/O PORTS:	Refer to user's manual
CABLE SUPPLIED	N/A

NOTE:

1. The above EUT information is declared by manufacturer and for more detailed features description, please refer to the manufacturer's specifications or user's manual.
2. For the test results, the EUT had been tested with all conditions, but only the worst case was shown in test report.
3. Please refer to the EUT photo document (Reference No.: 180831N010) for detailed product photo.
4. The EUT is wireless module, it no any accessories.
5. The EUT provides completed transmitter and receiver.

MODULATION MODE	TX FUNCTION
DSSS	1TX/1RX



2.2. DESCRIPTION OF TEST MODES

16 channels are provided:

CHANNEL	FREQUENCY	CHANNEL	FREQUENCY
11	2405 MHz	19	2445 MHz
12	2410 MHz	20	2450 MHz
13	2415 MHz	21	2455 MHz
14	2420 MHz	22	2460 MHz
15	2425 MHz	23	2465 MHz
16	2430 MHz	24	2470 MHz
17	2435 MHz	25	2475 MHz
18	2440 MHz	26	2480 MHz

TRANSMITTER UNWANTED EMISSION IN THE OUT-OF-BAND DOMAIN TEST:

- Pre-Scan has been conducted to determine the worst-case mode from all possible combinations between available modulations, data rates and antenna ports (if EUT with antenna diversity architecture).
- Following channel(s) was (were) selected for the final test as listed below.

Available Channel	Tested Channel	Modulation Technology	Modulation Type	Packet Type
11 to 26	11, 26	DSSS	OQPSK	250kbps

SPURIOUS EMISSIONS TEST (BELOW 1 GHz):

- Pre-Scan has been conducted to determine the worst-case mode from all possible combinations between available modulations, data rates and antenna ports (if EUT with antenna diversity architecture).
- Following channel(s) was (were) selected for the final test as listed below.

Available Channel	Tested Channel	Modulation Technology	Modulation Type	Packet Type
11 to 26	11	DSSS	OQPSK	250kbps

SPURIOUS EMISSIONS TEST (ABOVE 1 GHz):

- Pre-Scan has been conducted to determine the worst-case mode from all possible combinations between available modulations, data rates and antenna ports (if EUT with antenna diversity architecture).
- Following channel(s) was (were) selected for the final test as listed below.

Available Channel	Tested Channel	Modulation Technology	Modulation Type	Packet Type
11 to 26	11, 26	DSSS	OQPSK	250kbps

RECEIVER BLOCKING TEST:

- Following channel(s) was (were) selected for the final test as listed below.

MODE	AVAILABLE CHANNEL	TESTED CHANNEL	MODULATION TECHNOLOGY
11 to 26	11, 26	DSSS	OQPSK

RECEIVER BLOCKING TEST:

Following channel(s) was (were) selected for the final test as listed below.

Available Channel	Tested Channel	Modulation Technology	Modulation Type	Packet Type
11 to 26	11, 26	DSSS	OQPSK	250kbps

TEST CONDITION:

APPLICABLE TO	ENVIRONMENTAL CONDITIONS	INPUT POWER	TESTED BY
ROP	25deg. C, 60%RH	DC 3.7V from Battery	Robert Cheng
PSD	25deg. C, 60%RH	DC 3.7V from Battery	Robert Cheng
AD	N/A	N/A	N/A
OCB	25deg. C, 60%RH	DC 3.7V from Battery	Robert Cheng
OOB	25deg. C, 60%RH	DC 3.7V from Battery	Robert Cheng
SE<1G	23deg. C, 53%RH	DC 5V from Adapter	Tank
SE≥1G	23deg. C, 53%RH	DC 5V from Adapter	Tank
RB	25deg. C, 60%RH	DC 3.7V from Battery	Robert Cheng

2.3. GENERAL DESCRIPTION OF APPLIED STANDARDS

The EUT is a RF product, according to the specifications of the manufacturers. It must comply with the requirements of the following standards:

EN 300 328 V2.1.1 (2016-11)

All test items have been performed and recorded as per the above standards.

2.4. DESCRIPTION OF SUPPORT UNITS

The EUT has been tested as an independent unit together with other necessary accessories or support units. The following support units or accessories were used to form a representative test configuration during the tests.

NO.	PRODUCT	BRAND	MODEL NO.	SERIAL NO.	FCC ID
1	DC source	LONG WEI	PS-6403D	010934269	N/A
2	Li-ion Battery	N/A	DC3.7V	N/A	N/A
3	Adapter	N/A	DC5V 1.5A	N/A	N/A

NO.	SIGNAL CABLE DESCRIPTION OF THE ABOVE SUPPORT UNITS
1	DC Line: Unshielded, Detachable 1.0m
2	N/A
3	USB Line: Unshielded, Detachable 0.6m

NOTE: All power cords of the above support units are non-shielded (1.8m).

3 TEST PROCEDURES AND RESULTS

TRANSMITTER PARAMETERS

3.1. RF OUTPUT POWER

3.1.1 LIMITS OF RF OUTPUT POWER

CONDITION	FREQUENCY BAND	LIMIT (e.i.r.p.)
Under all test conditions	2400 ~ 2483.5 MHz	AV: 20dBm

3.1.2 TEST PROCEDURE

Refer to chapter 5.4.2.2 of ETSI EN 300 328 V2.1.1.

Measurement	
<input checked="" type="checkbox"/> Conducted measurement	<input type="checkbox"/> Radiated measurement

3.1.3 DEVIATION FROM TEST STANDARD

No deviation.

3.1.4 TEST SETUP

The measurement was performed at both normal environmental conditions and at the extremes of the operating temperature. The measurement was performed at the lowest, the middle, and the highest channel. The equipment was configured to operate under its worst case situation with respect to output power. (In case of conducted measurements the transmitter shall be connected to the measuring equipment via a suitable attenuator.) Controlling software has been activated to set the EUT on specific channel and power level.

3.1.5 TEST RESULTS

TEST CONDITION			EIRP POWER (dBm)			LIMIT (dBm)
			(CH11) 2405 MHz	(CH18) 2440 MHz	(CH26) 2480 MHz	
T _{nom} (°C)	+25	V _{nom} (V)	-1.10	-1.41	-1.80	20
T _{min} (°C)	-20	V _{nom} (V)	-0.77	-1.14	-1.60	20
T _{max} (°C)	+80	V _{nom} (V)	-1.44	-1.76	-2.18	20

NOTE: 1.EIRP = Conducted output power + ANT Gain

3.2. POWER SPECTRAL DENSITY

3.2.1 LIMIT OF POWER SPECTRAL DENSITY

CONDITION	FREQUENCY BAND	LIMIT (e.i.r.p.)
Under normal conditions	2400 ~ 2483.5 MHz	10dBm / 1MHz

3.2.2 TEST PROCEDURE

Refer to chapter 5.4.3.2 of ETSI EN 300 328 V2.1.1.

Measurement Method	
<input checked="" type="checkbox"/> Conducted measurement	<input type="checkbox"/> Radiated measurement
<input checked="" type="checkbox"/> Option 1: For equipment with continuous and non-continuous transmissions	
<input type="checkbox"/> Option 2: For equipment with continuous transmission capability or for equipment operating (or with the capability to operate) with a constant duty cycle (e.g. Frame Based equipment)	

3.2.3 DEVIATION FROM TEST STANDARD

No deviation.

3.2.4 TEST SETUP

The measurement was performed at normal environmental conditions only. The measurement was performed at the lowest, the middle, and the highest channel. The equipment was configured to operate under its worst case situation with respect to output power. (In case of conducted measurements the transmitter shall be connected to the measuring equipment via a suitable attenuator.) Controlling software has been activated to set the EUT on specific status.



3.2.5 TEST RESULTS

CHANNEL	CHANNEL FREQUENCY (MHz)	POWER DENSITY (dBm/1MHz) (E.I.R.P)	LIMIT (dBm/1MHz) (E.I.R.P)	PASS/FAIL
11	2405	-2.67	10	PASS
18	2440	-2.94	10	PASS
26	2480	-3.35	10	PASS

3.3. OCCUPIED CHANNEL BANDWIDTH

3.3.1 LIMIT OF OCCUPIED CHANNEL BANDWIDTH

CONDITION		LIMIT
All types of equipment		Shall fall completely within the band 2400 to 2483.5 MHz.
Additional requirement	For non-adaptive using wide band modulations other than FHSS system and e.i.r.p >10dBm.	Less than 20MHz
	For non-adaptive Frequency Hopping system and e.i.r.p >10dBm.	Less than 5MHz

3.3.2 TEST PROCEDURE

Refer to chapter 5.4.7.2 of ETSI EN 300 328 V2.1.1.

Measurement	
<input checked="" type="checkbox"/> Conducted measurement	<input type="checkbox"/> Radiated measurement

3.3.3 DEVIATION FROM TEST STANDARD

No deviation.

3.3.4 TEST SETUP

The measurement was performed at normal environmental conditions only. This measurement was performed at the lowest and the highest channel. The equipment was configured to operate under its worst case situation with respect to output power. (In case of conducted measurements the transmitter shall be connected to the measuring equipment via a suitable attenuator.) Controlling software has been activated to set the EUT on specific status.

3.3.5 TEST RESULTS

CHANNEL	CHANNEL FREQUENCY (MHz)	OCCUPIED BANDWIDTH (MHZ)	Measured frequencies		LIMIT	PASS/FAIL
			FL (MHz)	FH (MHz)		
11	2405	2.26	2403.86	2406.12	FL > 2.4 GHz and FH < 2.4835 GHz	PASS
26	2480	2.28	2478.86	2481.14		PASS

Note: FL is the lowest frequency of the 99% occupied bandwidth of power envelope.
FH is the highest frequency of the 99% occupied bandwidth of power envelope.



3.4. TRANSMITTER UNWANTED EMISSIONS IN THE OUT-OF-BAND DOMAIN

3.4.1 LIMITS OF TRANSMITTER UNWANTED EMISSIONS IN THE OUT-OF-BAND DOMAIN

CONDITION	LIMIT
Under all test conditions	The transmitter unwanted emissions in the out-of-band domain but outside the allocated band, shall not exceed the values provided by the mask in below figure.

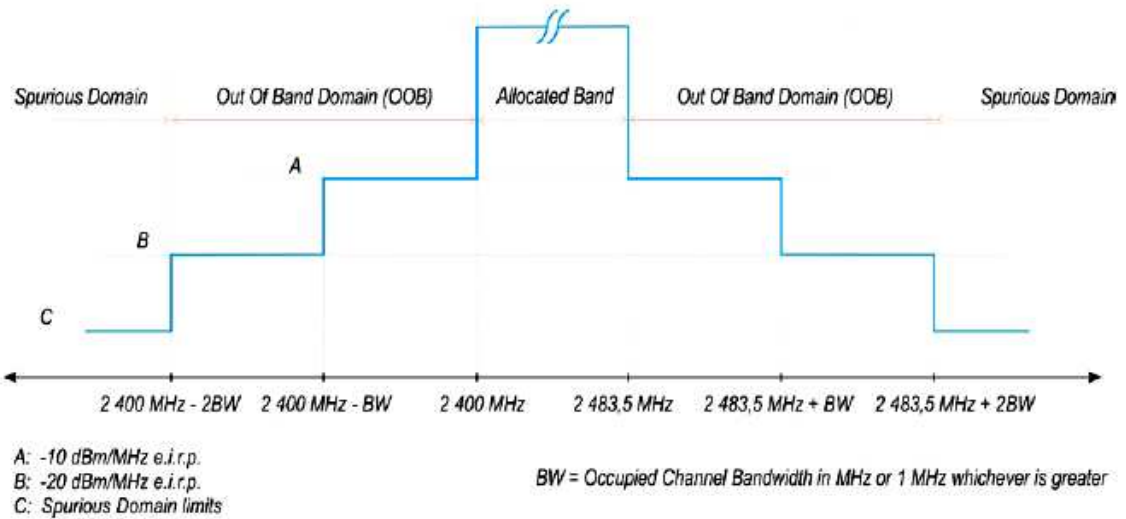

3.4.2 TEST PROCEDURE

Refer to chapter 5.4.8.2 of ETSI EN 300 328 V2.1.1.

Measurement	
<input checked="" type="checkbox"/> Conducted measurement	<input type="checkbox"/> Radiated measurement

3.4.3 DEVIATION FROM TEST STANDARD

No deviation.



3.4.4 TEST SETUP

The measurements were performed at normal environmental conditions and shall be repeated at the extremes of the operating temperature and voltage range. The measurement was performed at the lowest and the highest channel on which the equipment can operate. The equipment was configured to operate under its worst case situation with respect to output power. In case of conducted measurements the transmitter shall be connected to the measuring equipment via a suitable attenuator. The power source of the EUT has to be connected with the power supply for voltage change. The frequency has to be recorded for the right and left end above threshold of highest and lowest channel respectively.

3.4.5 TEST RESULTS

CHANNEL FREQ.(MHz)			2405				2480			
TEST CONDITION			OOB Emission (MHz)				OOB Emission (MHz)			
			2397.74 ~ 2400		2395.48 ~ 2397.74		2483.5 ~ 2485.78		2485.78 ~ 2488.06	
Temperature	Voltage		Freq. (MHz)	Power (dBm)	Freq. (MHz)	Power (dBm)	Freq. (MHz)	Power (dBm)	Freq. (MHz)	Power (dBm)
Tnorm(°C)	+25	Normal	2398.50	-69.47	2397.24	-69.79	2484.00	-68.86	2487.26	-69.33
Limit (dBm/MHz)			-10.00		-20.00		-10.00		-20.00	
PASS/FAIL			PASS		PASS		PASS		PASS	

3.5. TRANSMITTER SPURIOUS EMISSIONS

3.5.1 LIMITS OF TRANSMITTER SPURIOUS EMISSIONS

Transmitter limits for narrowband spurious emissions

Frequency Range	Maximum Power Limit (e.r.p. (≤ 1 GHz) e.i.r.p. (> 1 GHz))	Bandwidth
30 MHz to 47 MHz	-36dBm	100kHz
47 MHz to 74 MHz	-54dBm	100kHz
74 MHz to 87,5 MHz	-36dBm	100kHz
87,5 MHz to 118 MHz	-54dBm	100kHz
118 MHz to 174 MHz	-36dBm	100kHz
174 MHz to 230 MHz	-54dBm	100kHz
230 MHz to 470 MHz	-36dBm	100kHz
470 MHz to 862 MHz	-54dBm	100kHz
862 MHz to 1 GHz	-36dBm	100kHz
1GHz ~ 12.75GHz	-30dBm	1MHz

Note: These limits are e.r.p. for emissions up to 1 GHz and as e.i.r.p. for emissions above 1 GHz.

3.5.2 TEST PROCEDURE

Refer to chapter 5.4.9.2 of ETSI EN 300 328 V2.1.1.

Measurement	
<input type="checkbox"/> Conducted measurement	<input checked="" type="checkbox"/> Radiated measurement
<p><u>For Conducted measurement:</u></p> <p>The level of unwanted emissions shall be measured as their power in a specified load (conducted spurious emissions) and their effective radiated power when radiated by the cabinet or structure of the equipment with the antenna connector(s) terminated by a specified load (cabinet radiation).</p>	
<p><u>Conducted measurement (For equipment with multiple transmit chains):</u></p> <p><input type="checkbox"/> Option 1: The results for each of the transmit chains for the corresponding 1MHz segments shall be added and compared with the limits.</p> <p><input type="checkbox"/> Option 2: The results for each of the transmit chains shall be individually compared with the limits after these limits have been reduced by $10 \times \log(N)$ (number of active transmit chains)</p>	

3.5.3 DEVIATION FROM TEST STANDARD

No deviation.

3.5.4 TEST SETUP

1. For the actual test configuration, please refer to the related Item in this test report (Photographs of the Test Configuration).
2. The measurements were performed when normal hopping was disabled. In this case measurements were performed when operating at the lowest and the highest hopping frequency.
3. The equipment was configured to operate under its worst case situation with respect to output power.
4. The test setup has been constructed as the normal use condition. Controlling software has been activated to set the EUT on specific status.

3.5.5 TEST RESULTS

BELOW 1GHz WORST-CASE DATA

SPURIOUS EMISSION FREQUENCY RANGE	30MHz ~ 1GHz	OPERATING CHANNEL	11
--	--------------	--------------------------	----

SPURIOUS EMISSION LEVEL				
Frequency (MHz)	Antenna Polarization	Level (dBm)	Limit (dBm)	Margin (dB)
198.20	H	-59.63	-54.00	-5.63
282.62	H	-56.93	-36.00	-20.93
504.78	H	-65.37	-54.00	-11.37
550.99	H	-67.48	-54.00	-13.48
573.49	H	-68.29	-54.00	-14.29
707.97	H	-70.27	-54.00	-16.27

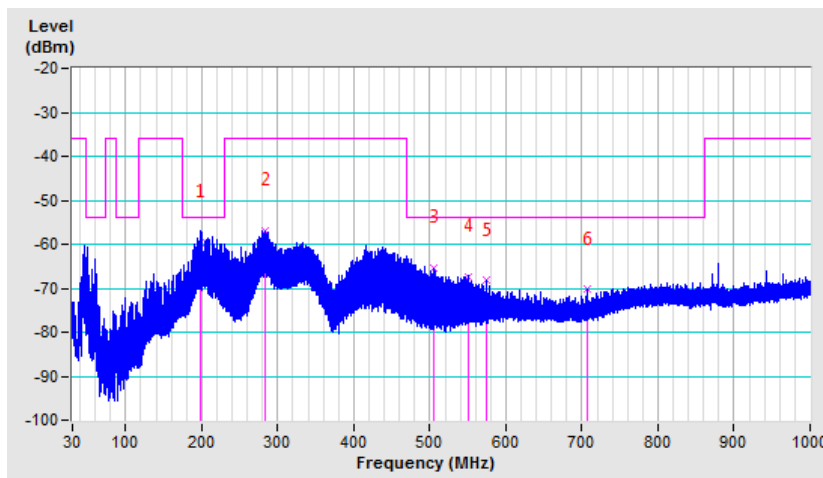

SPURIOUS EMISSION FREQUENCY RANGE	30MHz ~ 1GHz	OPERATING CHANNEL	11
--	--------------	------------------------------	----

SPURIOUS EMISSION LEVEL				
Frequency (MHz)	Antenna Polarization	Level (dBm)	Limit (dBm)	Margin (dB)
59.10	V	-63.45	-54.00	-9.45
198.42	V	-65.90	-54.00	-11.90
501.00	V	-67.95	-54.00	-13.95
558.55	V	-66.94	-54.00	-12.94
665.38	V	-71.28	-54.00	-17.28
776.90	V	-70.33	-54.00	-16.33

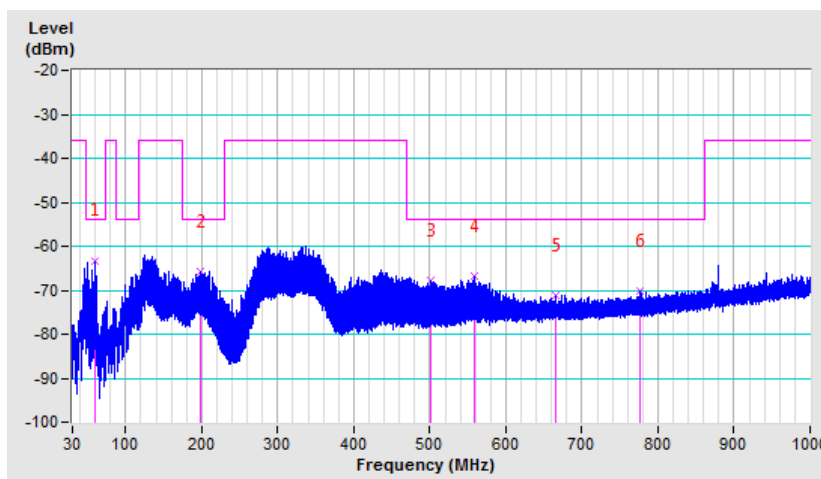

ABOVE 1GHz WORST-CASE DATA

SPURIOUS EMISSION FREQUENCY RANGE	1GHz ~ 12.75GHz	OPERATING CHANNEL	11, 26
--	-----------------	------------------------------	--------

SPURIOUS EMISSION LEVEL					
Channel	Frequency (MHz)	Antenna Polarization	Level (dBm)	Limit (dBm)	Margin (dB)
11	4810.00	H	-58.26	-30.00	-28.26
	4810.00	V	-56.70	-30.00	-26.70
	7215.00	H	-52.32	-30.00	-22.32
	7215.00	V	-53.21	-30.00	-23.21
26	4960.00	H	-55.01	-30.00	-25.01
	4960.00	V	-54.59	-30.00	-24.59
	7440.00	H	-52.68	-30.00	-22.68
	7440.00	V	-51.45	-30.00	-21.45

RECEIVER PARAMETERS

3.6. RECEIVER SPURIOUS RADIATION

3.6.1 LIMITS OF RECEIVER SPURIOUS RADIATION

Frequency Range	Maximum Power Limit (e.r.p. (\leq 1 GHz) e.i.r.p. ($>$ 1 GHz))
30MHz ~ 1GHz	-57dBm
1GHz ~ 12.75GHz	-47dBm

Note: These limits are e.r.p. for emissions up to 1 GHz and as e.i.r.p. for emissions above 1 GHz.

3.6.2 TEST PROCEDURE

Refer to chapter 5.4.10.2 of ETSI EN 300 328 V2.1.1.

Measurement	
<input type="checkbox"/> Conducted measurement	<input checked="" type="checkbox"/> Radiated measurement
<p><u>For Conducted measurement:</u> The level of unwanted emissions shall be measured as their power in a specified load (conducted spurious emissions) and their effective radiated power when radiated by the cabinet or structure of the equipment with the antenna connector(s) terminated by a specified load (cabinet radiation).</p>	
<p><u>Conducted measurement (For equipment with multiple transmit chains):</u></p> <p><input type="checkbox"/> Option 1: The results for each of the transmit chains for the corresponding 1MHz segments shall be added and compared with the limits.</p> <p><input type="checkbox"/> Option 2: The results for each of the transmit chains shall be individually compared with the limits after these limits have been reduced by $10 \times \log(N)$ (number of active transmit chains)</p>	

3.6.3 DEVIATION FROM TEST STANDARD

No deviation.

3.6.4 TEST SETUP

1. For the actual test configuration, please refer to the related Item in this test report (Photographs of the Test Configuration).
2. Testing was performed when the equipment was in a receive-only mode.
3. The measurements were performed when normal hopping was disabled. In this case measurements were performed when operating at the lowest and the highest hopping frequency.
4. The test setup has been constructed as the normal use condition. Controlling software has been activated to set the EUT on specific status.

3.6.5 TEST RESULTS

RX WORST-CASE DATA

SPURIOUS EMISSION FREQUENCY RANGE	30MHz ~ 1GHz	OPERATING CHANNEL	11
--	--------------	------------------------------	----

SPURIOUS EMISSION LEVEL				
Frequency (MHz)	Antenna Polarization	Level (dBm)	Limit (dBm)	Margin (dB)
49.17	H	-61.24	-57.00	-4.24
219.21	H	-63.54	-57.00	-6.54
285.27	H	-60.35	-57.00	-3.35
441.15	H	-63.84	-57.00	-6.84
476.33	H	-63.62	-57.00	-6.62
879.49	H	-64.85	-57.00	-7.85

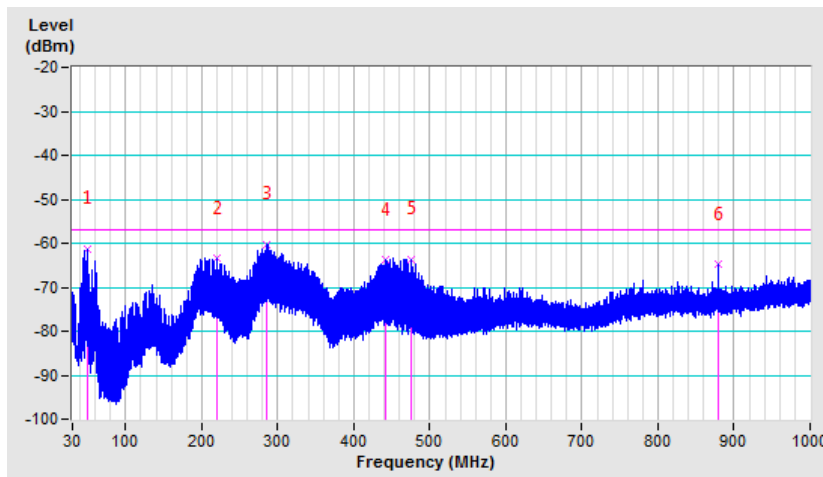

SPURIOUS EMISSION FREQUENCY RANGE	30MHz ~ 1GHz	OPERATING CHANNEL	11
--	--------------	------------------------------	----

SPURIOUS EMISSION LEVEL				
Frequency (MHz)	Antenna Polarization	Level (dBm)	Limit (dBm)	Margin (dB)
59.00	V	-63.54	-57.00	-6.54
127.87	V	-62.99	-57.00	-5.99
299.30	V	-64.50	-57.00	-7.50
435.65	V	-65.53	-57.00	-8.53
879.46	V	-65.03	-57.00	-8.03
943.35	V	-66.01	-57.00	-9.01

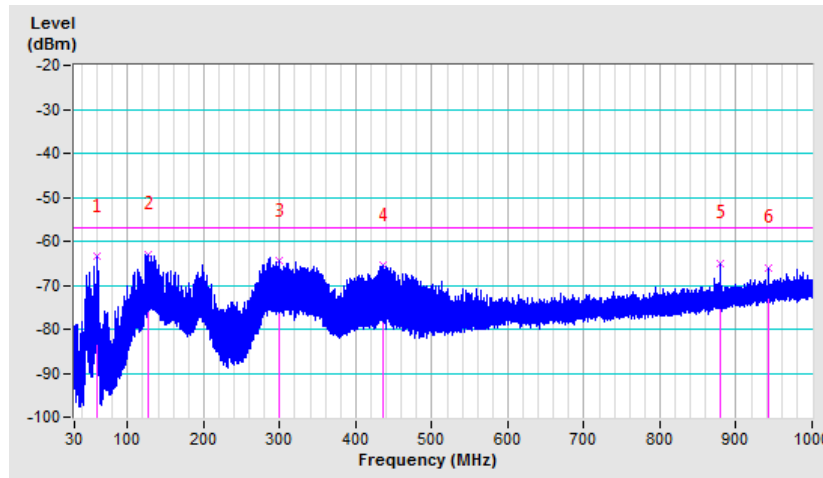



RX ABOVE 1GHz DATA

SPURIOUS EMISSION FREQUENCY RANGE	1GHz ~ 12.75GHz	OPERATING CHANNEL	11, 26
--	-----------------	--------------------------	--------

SPURIOUS EMISSION LEVEL					
Channel	Frequency (MHz)	Antenna Polarization	Level (dBm)	Limit (dBm)	Margin (dB)
11	4810.00	H	-56.83	-47.00	-9.83
	4810.00	V	-58.12	-47.00	-11.12
	7215.00	H	-52.24	-47.00	-5.24
	7215.00	V	-53.91	-47.00	-6.91
26	4960.00	H	-56.35	-47.00	-9.35
	4960.00	V	-55.72	-47.00	-8.72
	7440.00	H	-51.74	-47.00	-4.74
	7440.00	V	-52.74	-47.00	-5.74

3.7. RECEIVER BLOCKING

3.7.1. LIMITS OF RECEIVER BLOCKING

This requirement applies to all receiver categories.

Receiver Category		
<input type="checkbox"/> Category 1(EIRP>10dBm)	<input type="checkbox"/> Category 2(EIRP ≤10dBm)	<input checked="" type="checkbox"/> Category 3(EIRP ≤0dBm)
Minimum performance criterion	<input checked="" type="checkbox"/> PER ≤10%	
	<input type="checkbox"/> Alternative performance criteria (See note)	
Note: The manufacturer was declared performance criteria is x% for the intended use of the equipment.		

Receiver Category 1 Equipment			
Wanted signal mean power from companion device (dBm)	Blocking Signal Frequency (MHz)	Blocking Signal Power (dBm) (See note 2)	Type of blocking signal
$P_{min} + 6$ dB	2 380 2 503.5	-53	CW
$P_{min} + 6$ dB	2 300 2 330 2 360	-47	CW
$P_{min} + 6$ dB	2 523.5 2 553.5 2 583.5 2 613.5 2 643.5 2 673.5	-47	CW
NOTE 1: P_{min} is the minimum level of the wanted signal (in dBm) required to meet the minimum performance criteria as defined in clause 4.3.2.11.3 in the absence of any blocking signal.			
NOTE 2: The levels specified are levels in front of the UUT antenna. In case of conducted measurements, the levels have to be corrected by the actual antenna assembly gain.			

Receiver Category 2 Equipment			
Wanted signal mean power from companion device (dBm)	Blocking Signal Frequency (MHz)	Blocking Signal Power (dBm) (See note 2)	Type of blocking signal
$P_{min} + 6$ dB	2 380 2 503.5	-57	CW
$P_{min} + 6$ dB	2 300 2 583.5	-47	CW
NOTE 1: P_{min} is the minimum level of the wanted signal (in dBm) required to meet the minimum performance criteria as defined in clause 4.3.2.11.3 in the absence of any blocking signal.			
NOTE 2: The levels specified are levels in front of the UUT antenna. In case of conducted measurements, the levels have to be corrected by the actual antenna assembly gain.			

Receiver Category 3 Equipment			
Wanted signal mean power from companion device (dBm)	Blocking Signal Frequency (MHz)	Blocking Signal Power (dBm) (See note 2)	Type of blocking signal
$P_{\min} + 12$ dB	2 380 2 503.5	-57	CW
$P_{\min} + 12$ dB	2 300 2 583.5	-47	CW
NOTE 1: P_{\min} is the minimum level of the wanted signal (in dBm) required to meet the minimum performance criteria as defined in clause 4.3.2.11.3 in the absence of any blocking signal. NOTE 2: The levels specified are levels in front of the UUT antenna. In case of conducted measurements, the levels have to be corrected by the actual antenna assembly gain.			

3.7.2. TEST PROCEDURE

Refer to chapter 5.4.11.2. of ETSI EN 300 328 V2.1.1.

Measurement	
<input checked="" type="checkbox"/> Conducted measurement	<input type="checkbox"/> Radiated measurement

3.7.3. DEVIATION FROM TEST STANDARD

No deviation.

3.7.4. TEST SETUP CONFIGURATION

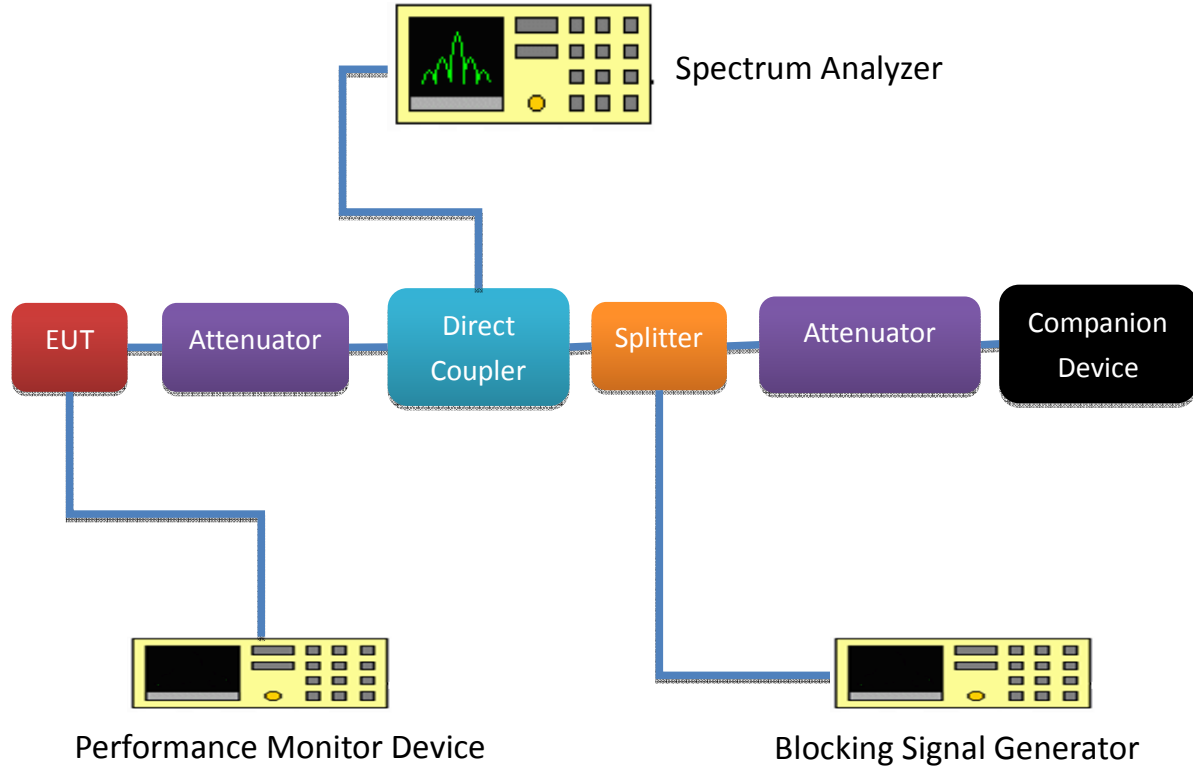

3.7.5. TEST RESULT

Receiver Category 3 Equipment

Receiver blocking performance when operating at the lowest operating channel(CH11)				
P _{min} : -89.44dBm			antenna gain(G) : 0dBi	
The actual blocking signal power(Note1)			<input checked="" type="checkbox"/> at the antenna connector	
			<input type="checkbox"/> in front of the antenna	
Note1: For the conducted measurements , the level shall be corrected as follows: the actual blocking signal power = blocking signal power + G				
Wanted signal mean power from companion device (dBm)	Blocking signal frequency (MHz)	The actual blocking signal power (dBm)	PER(%)	Pass/Fail
P _{min} + 12 dB	2380	-57	1.47	PASS
	2503.5	-57	0.81	PASS
	2300	-47	0.59	PASS
	2583.5	-47	0.24	PASS

Receiver blocking performance when operating at the Highest operating channel(CH26)				
P _{min} : -91.05dBm			antenna gain(G) : 0dBi	
The actual blocking signal power(Note1)			<input checked="" type="checkbox"/> at the antenna connector	
			<input type="checkbox"/> in front of the antenna	
Note1: For the conducted measurements , the level shall be corrected as follows: the actual blocking signal power = blocking signal power + G				
Wanted signal mean power from companion device (dBm)	Blocking signal frequency (MHz)	The actual blocking signal power (dBm)	PER(%)	Pass/Fail
P _{min} + 12 dB	2380	-57	0.00	PASS
	2503.5	-57	0.17	PASS
	2300	-47	0.00	PASS
	2583.5	-47	0.33	PASS

4 PHOTOGRAPHS OF THE TEST CONFIGURATION

SPURIOUS EMISSION TEST BELOW 1GHZ



SPURIOUS EMISSION TEST ABOVE 1GHZ



Receiving Blocking





5 APPENDIX A – MODIFICATIONS RECORDERS FOR ENGINEERING CHANGES TO THE EUT BY THE LAB

No any modifications were made to the EUT by the lab during the test.

--- END ---