

FCC TEST REPORT (PART 24)



Applicant:	Particle Industries, Inc
Address:	126 Post St, 4th floor, San Francisco, CA 94108 USA

Manufacturer or Supplier:	Particle Industries, Inc
Address:	126 Post St, 4th floor, San Francisco, CA 94108 USA
Product:	Boron LTE
Brand Name:	Particle Industries, Inc
Model Name:	BRN402
FCC ID:	2AEMI-BRN402
Date of tests:	Oct. 09, 2018 ~ Nov. 08, 2018

The tests have been carried out according to the requirements of the following standard:

- FCC PART 24, Subpart E** **ANSI C63.26-2015**
 ANSI/TIA/EIA-603-D **ANSI/TIA/EIA-603-E**

CONCLUSION: The submitted sample was found to COMPLY with the test requirement

Prepared by Roger Li Engineer / Mobile Department	Approved by Sam Tung Manager / Mobile Department
	
Date: Nov. 09, 2018	Date: Nov. 09, 2018

This report is governed by, and incorporates by reference, CPS Conditions of Service as posted at the date of issuance of this report at <http://www.bureauveritas.com/home/about-us/our-business/cps/about-us/terms-conditions> and is intended for your exclusive use. Any copying or replication of this report to or for any other person or entity, or use of our name or trademark, is permitted only with our prior written permission. This report sets forth our findings solely with respect to the test samples identified herein. The results set forth in this report are not indicative or representative of the quality or characteristics of the lot from which a test sample was taken or any similar or identical product unless specifically and expressly noted. Our report includes all of the tests requested by you and the results thereof based upon the information that you provided to us. Measurement uncertainty is only provided upon request for accredited tests. You have 60 days from date of issuance of this report to notify us of any material error or omission caused by our negligence or if you require measurement uncertainty; provided, however, that such notice shall be in writing and shall specifically address the issue you wish to raise. A failure to raise such issue within the prescribed time shall constitute your unqualified acceptance of the completeness of this report, the tests conducted and the correctness of the report contents.



TABLE OF CONTENTS

RELEASE CONTROL RECORD	4
1 SUMMARY OF TEST RESULTS.....	5
1.1 MEASUREMENT UNCERTAINTY	5
1.2 TEST SITE AND INSTRUMENTS	6
2 GENERAL INFORMATION	7
2.1 GENERAL DESCRIPTION OF EUT.....	7
2.2 CONFIGURATION OF SYSTEM UNDER TEST	9
2.3 DESCRIPTION OF SUPPORT UNITS.....	10
2.4 TEST ITEM AND TEST CONFIGURATION	10
2.5 EUT OPERATING CONDITIONS.....	13
2.6 GENERAL DESCRIPTION OF APPLIED STANDARDS	13
3 TEST TYPES AND RESULTS.....	14
3.1 OUTPUT POWER MEASUREMENT	14
3.1.1 LIMITS OF OUTPUT POWER MEASUREMENT	14
3.1.2 TEST PROCEDURES	14
3.1.3 TEST SETUP	14
3.1.4 TEST RESULTS	16
3.2 FREQUENCY STABILITY MEASUREMENT	21
3.2.1 LIMITS OF FREQUENCY STABILITY MEASUREMENT	21
3.2.2 TEST PROCEDURE.....	21
3.2.3 TEST SETUP.....	21
3.2.4 TEST RESULTS	21
3.3 OCCUPIED BANDWIDTH MEASUREMENT	22
3.3.1 TEST PROCEDURES	22
3.3.2 TEST SETUP.....	22
3.3.3 TEST RESULTS	22
3.4 BAND EDGE MEASUREMENT	23
3.4.1 LIMITS OF BAND EDGE MEASUREMENT.....	23
3.4.2 TEST SETUP.....	23
3.4.3 TEST PROCEDURES	24
3.4.4. TEST RESULTS.....	24
3.5 CONDUCTED SPURIOUS EMISSIONS	25
3.5.1 LIMITS OF CONDUCTED SPURIOUS EMISSIONS MEASUREMENT.....	25
3.5.2 TEST PROCEDURE.....	25
3.5.3 TEST SETUP.....	25
3.5.4 TEST RESULTS	25
3.6 RADIATED EMISSION MEASUREMENT	26
3.6.1 LIMITS OF RADIATED EMISSION MEASUREMENT	26
3.6.2 TEST PROCEDURES	26
3.6.3 DEVIATION FROM TEST STANDARD	26
3.6.4 TEST SETUP.....	27
3.6.5 TEST RESULTS	29
3.7 PEAK TO AVERAGE RATIO	47
3.7.1 LIMITS OF PEAK TO AVERAGE RATIO MEASUREMENT.....	47
3.7.2 TEST SETUP.....	47
3.7.3 TEST PROCEDURES	47
3.7.4 TEST RESULTS	47



BUREAU
VERITAS

Test Report No.: RF181008W004-2

4	INFORMATION ON THE TESTING LABORATORIES	48
5	APPENDIX A – MODIFICATIONS RECORDERS FOR ENGINEERING CHANGES TO THE EUT BY THE LAB	49



BUREAU
VERITAS

Test Report No.: RF181008W004-2

RELEASE CONTROL RECORD

ISSUE NO.	REASON FOR CHANGE	DATE ISSUED
RF181008W004-2	Original release	Nov. 09, 2018

1 SUMMARY OF TEST RESULTS

The EUT has been tested according to the following specifications:

APPLIED STANDARD: FCC Part 24 & Part 2			
STANDARD SECTION	TEST TYPE	RESULT	REMARK
2.1046 24.232	Equivalent Isotropic Radiated Power	PASS	Meet the requirement of limit.
2.1055 24.235	Frequency Stability	N/A(see note)	Meet the requirement of limit.
2.1049 24.238(b)	Occupied Bandwidth	N/A(see note)	Meet the requirement of limit.
24.232(d)	Peak to average ratio	N/A(see note)	Meet the requirement of limit.
24.238(b)	Band Edge Measurements	N/A(see note)	Meet the requirement of limit.
2.1051 24.238	Conducted Spurious Emissions	N/A(see note)	Meet the requirement of limit.
2.1053 24.238	Radiated Spurious Emissions	PASS	Meet the requirement of limit. Minimum passing margin is -17.70dB at 32.850MHz.

Note: The product Particle BRN402 is fully integrated the LTE Cat-M1 Module SARA-R410M (FCC ID: XPY2AGQN4NNN), no other modification on the LTE Cat-M1 Module radio parameter such as power, frequency range, modulation etc., for this report only test Effective Radiated Power and Radiated Spurious Emissions, other test data are copied from the module report. Please refer to this report for details.

1.1 MEASUREMENT UNCERTAINTY

Where relevant, the following measurement uncertainty levels have been estimated for tests performed on the EUT as specified in CISPR 16-4-2:

MEASUREMENT	FREQUENCY	UNCERTAINTY
Conducted emissions	9kHz~30MHz	2.66dB
Radiated emissions	9KHz ~ 30MHz	2.68dB
	30MHz ~ 1GHz	3.26dB
	1GHz ~ 18GHz	4.48dB
	18GHz ~ 40GHz	4.12dB

This uncertainty represents an expanded uncertainty expressed at approximately the 95% confidence level using a coverage factor of k=2.



1.2 TEST SITE AND INSTRUMENTS

Equipment	Manufacturer	Model No.	Serial No.	Last Cal.	Next Cal.
MXE EMI Receiver	KEYSIGHT	N9038A-544	MY54450026	Mar. 16,18	Mar. 15,19
EXA Signal Analyzer	KEYSIGHT	N9010A-526	MY54510322	Mar. 16,18	Mar. 15,19
Bilog Antenna 1	ETS-LINDGREN	3143B	00161964	Nov. 26,16	Nov. 25,18
Bilog Antenna 2	ETS-LINDGREN	3143B	00161965	Nov. 26,16	Nov. 25,18
Horn Antenna 1	ETS-LINDGREN	3117	00168728	Nov. 26,16	Nov. 25,18
Horn Antenna 2	ETS-LINDGREN	3117	00168692	Nov. 26,16	Nov. 25,18
Loop antenna	Daze	ZN30900A	0708	Nov. 20,17	Nov. 19,18
Horn Antenna (18GHz-40GHz)	N/A	QWH-SL-18-40 -K-SG/QMS-00 361	15433	Dec. 16,16	Dec. 15,18
Radio Communication Analyzer	ANRITSU	MT8820C	6201465426	Mar. 02,18	Mar. 01,19
Signal Pre-Amplifier	EMSI	EMC 9135	980249	Jul. 09,18	Jul. 08,19
Signal Pre-Amplifier	EMSI	EMC 012645B	980257	Jul. 09,18	Jul. 08,19
Signal Pre-Amplifier	EMSI	EMC 184045B	980259	Jul. 09,18	Jul. 08,19
3m Semi-anechoic Chamber	ETS-LINDGREN	9m*6m*6m	Euroshieldpn- CT0001143-1216	Apr. 21,18	Apr. 20,19
Test Software	E3	V 9.160323	N/A	N/A	N/A
Test Software	ADT	ADT_Radiated _V7.6.15.9.2	N/A	N/A	N/A
10dB Attenuator	JFW/USA	50HF-010-SM A	1505	Jul. 09,18	Jul. 08,19
Power Meter	Anritsu	ML2495A	1506002	Mar. 02,18	Mar. 01,19
Power Sensor	Anritsu	MA2411B	1339352	Mar. 16,18	Mar. 15,19
Humid & Temp Programmable Tester	Juyi	ITH-120-45-CP -AR	IAA1504-001	Jul. 09,18	Jul. 08,19
MXG Analog Microvave Signal Generator	KEYSIGHT	N5183A	MY50143024	Mar. 13,18	Mar. 12,19

NOTE: 1. The calibration interval of the above test instruments is 12 months or 24 months and the calibrations are traceable to CEPREI/CHINA, GRGT/CHINA and NIM/CHINA.

2. The test was performed in 3m Semi-anechoic Chamber and RF Oven Room.

3. The horn antenna is used only for the measurement of emission frequency above 1GHz if tested.

4. The FCC Site Registration No. is 525120; The Designation No. is CN1171.



2 GENERAL INFORMATION

2.1 GENERAL DESCRIPTION OF EUT

PRODUCT	Boron LTE	
BRAND NAME	Particle Industries, Inc	
MODEL NAME	BRN402	
POWER SUPPLY	5.0Vdc (Adapter) 3.7Vdc (battery)	
MODULATION TYPE	QPSK, 16QAM	
FREQUENCY RANGE	LTE Band 2 Channel Bandwidth: 1.4MHz	1850.7MHz ~ 1909.3MHz
	LTE Band 2 Channel Bandwidth: 3MHz	1851.5MHz ~ 1908.5MHz
	LTE Band 2 Channel Bandwidth: 5MHz	1852.5MHz ~ 1907.5MHz
	LTE Band 2 Channel Bandwidth: 10MHz	1855.0MHz ~ 1905.0MHz
	LTE Band 2 Channel Bandwidth: 15MHz	1857.5MHz ~ 1902.5MHz
	LTE Band 2 Channel Bandwidth: 20MHz	1860.0MHz ~ 1900.0MHz
MAX. EIRP POWER	LTE Band 2 Channel Bandwidth: 1.4MHz	1075mW
	LTE Band 2 Channel Bandwidth: 3MHz	1077mW
	LTE Band 2 Channel Bandwidth: 5MHz	1064mW
	LTE Band 2 Channel Bandwidth: 10MHz	1120mW
	LTE Band 2 Channel Bandwidth: 15MHz	1449mW
	LTE Band 2 Channel Bandwidth: 20MHz	904mW
EMISSION DESIGNATOR	LTE Band 2	QPSK: 1M11G7D
		16QAM: 1M11W7D
ANTENNA TYPE	Fixed External antenna with 3.5dBi gain	
HW VERSION	V1.00	
SW VERSION	V0.8.0	
I/O PORTS	Refer to user's manual	
CABLE SUPPLIED	N/A	



Test Report No.: RF181008W004-2

NOTE:

1. For a more detailed features description, please refer to the manufacturer's specifications or the user's manual.
2. For the test results, the EUT had been tested with all conditions. But only the worst case was shown in test report.



2.2 CONFIGURATION OF SYSTEM UNDER TEST

FOR RADIATION EMISSION TEST

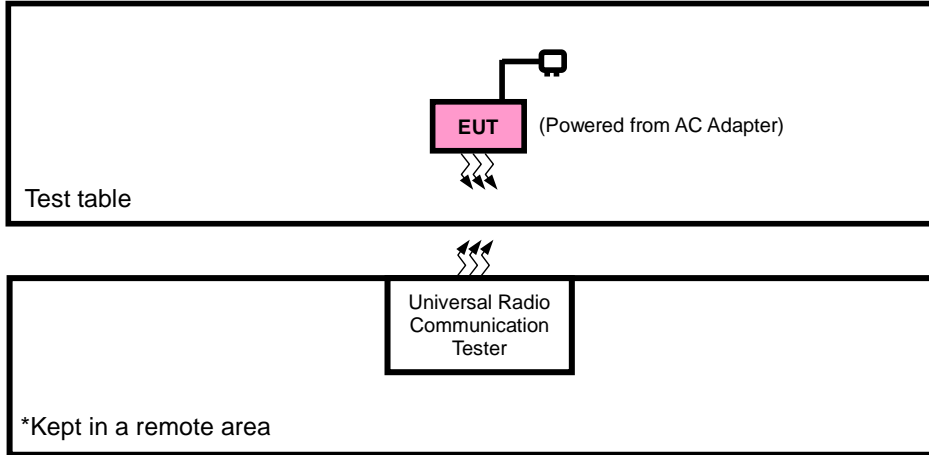

FOR CONDUCTED & E.I.R.P. TEST

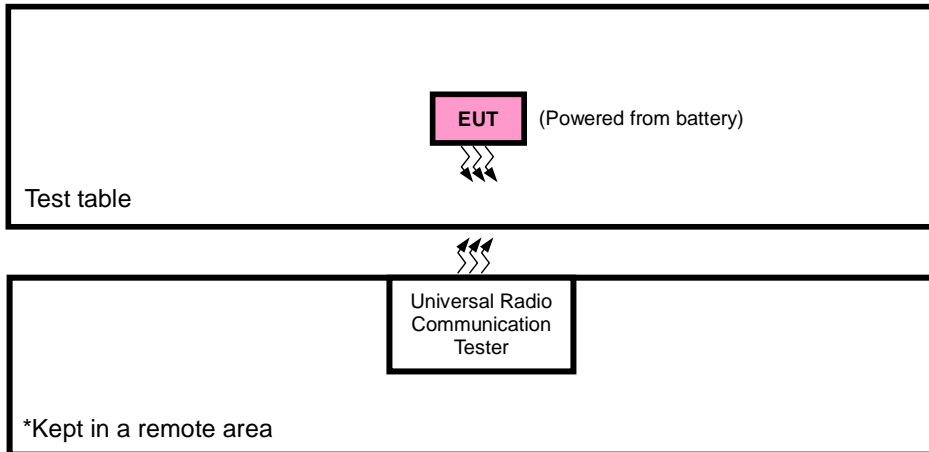



2.3 DESCRIPTION OF SUPPORT UNITS

The EUT has been tested as an independent unit together with other necessary accessories or support units. The following support units or accessories were used to form a representative test configuration during the tests.

NO.	PRODUCT	BRAND	MODEL NO.	SERIAL NO.	FCC ID
1	DC source	LONG WEI	PS-6403D	010934269	N/A
2	PC	HP	A6608CN	3CR83825X3	N/A
3	USB	N/A	N/A	N/A	N/A
4	Battery	N/A	N/A	N/A	N/A
5	Adapter	N/A	N/A	N/A	N/A

NO.	SIGNAL CABLE DESCRIPTION OF THE ABOVE SUPPORT UNITS
1	DC Line: Unshielded, Detachable 1.0m
2	AC Line: Unshielded, Detachable 1.5m
3	N/A
4	N/A
5	N/A

NOTE:

1. All power cords of the above support units are non shielded (1.8m).

2.4 TEST ITEM AND TEST CONFIGURATION

Pre-Scan has been conducted to determine the worst-case mode from all possible combinations between available modulations, data rates, XYZ axis and antenna ports. The worst case in EIRP and radiated emission was found when positioned on X-plane for LTE. Following channel(s) was (were) selected for the final test as listed below:

EUT CONFIGURE MODE	DESCRIPTION
A	EUT + Adapter + USB Cable with LTE link
B	EUT + Battery with LTE link



LTE BAND 2

EUT CONFIGURE MODE	TEST ITEM	AVAILABLE CHANNEL	TESTED CHANNEL	CHANNEL BANDWIDTH	MODULATION	MODE
B	EIRP	18607 to 19193	18607, 18900, 19193	1.4MHz	QPSK,16QAM	1 RB / 0 RB Offset
		18615 to 19185	18615, 18900, 19185	3MHz	QPSK,16QAM	1 RB / 0 RB Offset
		18625 to 19175	18625, 18900, 19175	5MHz	QPSK,16QAM	1 RB / 0 RB Offset
		18650 to 19150	18650, 18900, 19150	10MHz	QPSK,16QAM	1 RB / 0 RB Offset
		18675 to 19125	18675, 18900, 19125	15MHz	QPSK,16QAM	1 RB / 0 RB Offset
		18700 to 19100	18700, 18900, 19100	20MHz	QPSK,16QAM	1 RB / 0 RB Offset
B	FREQUENCY STABILITY	18607 to 19193	18607, 19193	1.4MHz	QPSK	1 RB / 0 RB Offset
		18615 to 19185	18615, 19185	3MHz	QPSK	1 RB / 0 RB Offset
		18625 to 19175	18625, 19175	5MHz	QPSK	1 RB / 0 RB Offset
		18650 to 19150	18650, 19150	10MHz	QPSK	1 RB / 0 RB Offset
		18675 to 19125	18675, 19125	15MHz	QPSK	1 RB / 0 RB Offset
		18700 to 19100	18700, 19100	20MHz	QPSK	1 RB / 0 RB Offset
B	OCCUPIED BANDWIDTH	18607 to 19193	18607, 18900, 19193	1.4MHz	QPSK,16QAM	6 RB / 0 RB Offset
		18615 to 19185	18615, 18900, 19185	3MHz	QPSK,16QAM	15 RB / 0 RB Offset
		18625 to 19175	18625, 18900, 19175	5MHz	QPSK,16QAM	25 RB / 0 RB Offset
		18650 to 19150	18650, 18900, 19150	10MHz	QPSK,16QAM	50 RB / 0 RB Offset
		18675 to 19125	18675, 18900, 19125	15MHz	QPSK,16QAM	75 RB / 0 RB Offset
		18700 to 19100	18700, 18900, 19100	20MHz	QPSK,16QAM	100 RB / 0 RB Offset
B	PEAK TO AVERAGE RATIO	18607 to 19193	18607, 18900, 19193	1.4MHz	QPSK,16QAM	1 RB / 0 RB Offset
		18615 to 19185	18615, 18900, 19185	3MHz	QPSK,16QAM	1 RB / 0 RB Offset
		18625 to 19175	18625, 18900, 19175	5MHz	QPSK,16QAM	1 RB / 0 RB Offset
		18650 to 19150	18650, 18900, 19150	10MHz	QPSK,16QAM	1 RB / 0 RB Offset
		18675 to 19125	18675, 18900, 19125	15MHz	QPSK,16QAM	1 RB / 0 RB Offset
		18700 to 19100	18700, 18900, 19100	20MHz	QPSK,16QAM	1 RB / 0 RB Offset



B	BAND EDGE	18607 to 19193	18607	1.4MHz	QPSK	1 RB / 0 RB Offset		
			19193	1.4MHz	QPSK	6 RB / 0 RB Offset		
		18615 to 19185	18615	3MHz	QPSK	1 RB / 5 RB Offset		
			19185	3MHz	QPSK	6 RB / 0 RB Offset		
		18625 to 19175	18625	5MHz	QPSK	1 RB / 0 RB Offset		
			19175	5MHz	QPSK	15 RB / 0 RB Offset		
		18650 to 19150	18650	10MHz	QPSK	1 RB / 14 RB Offset		
			19150	10MHz	QPSK	15 RB / 0 RB Offset		
		18675 to 19125	18675	15MHz	QPSK	1 RB / 0 RB Offset		
			19125	15MHz	QPSK	25 RB / 0 RB Offset		
		18700 to 19100	18700	20MHz	QPSK	1 RB / 24 RB Offset		
			19100	20MHz	QPSK	25 RB / 0 RB Offset		
		B	CONDCUETED EMISSION	18607 to 19193	18607, 18900, 19193	1.4MHz	QPSK	1 RB / 0 RB Offset
				18615 to 19185	18615, 18900, 19185	3MHz	QPSK	50 RB / 0 RB Offset
18625 to 19175	18625, 18900, 19175			5MHz	QPSK	1 RB / 49 RB Offset		
18650 to 19150	18650, 18900, 19150			10MHz	QPSK	50 RB / 0 RB Offset		
18675 to 19125	18675, 18900, 19125			15MHz	QPSK	1 RB / 0 RB Offset		
18700 to 19100	18700, 18900, 19100			20MHz	QPSK	75 RB / 0 RB Offset		
A	RADIATED EMISSION	18607 to 19193	18900	1.4MHz	QPSK	1 RB / 74 RB Offset		
		18615 to 19185	18900	3MHz	QPSK	75 RB / 0 RB Offset		
		18625 to 19175	18900	5MHz	QPSK	1 RB / 0 RB Offset		
		18650 to 19150	18650, 18900, 19150	10MHz	QPSK	1 RB / 0 RB Offset		
		18675 to 19125	18900	15MHz	QPSK	1 RB / 0 RB Offset		
		18700 to 19100	18900	20MHz	QPSK	1 RB / 99 RB Offset		

TEST CONDITION:

TEST ITEM	ENVIRONMENTAL CONDITIONS	INPUT POWER	TESTED BY
EIRP	25deg. C, 57%RH	3.7Vdc from Battery	Star Le
FREQUENCY STABILITY	23deg. C, 61%RH	DC 3.3V/5V/5.5V	Rain Wang
OCCUPIED BANDWIDTH	23deg. C, 61%RH	3.7Vdc from Battery	Rain Wang
PEAK TO AVERAGE RATIO	23deg. C, 61%RH	3.7Vdc from Battery	Rain Wang
BAND EDGE	23deg. C, 61%RH	3.7Vdc from Battery	Rain Wang
CONDCUETED EMISSION	23deg. C, 61%RH	3.7Vdc from Battery	Rain Wang
RADIATED EMISSION	23deg. C, 70%RH	5Vdc from adapter	Star Le



2.5 EUT OPERATING CONDITIONS

The EUT makes a call to the communication simulator. The communication simulator station system controlled a EUT to export maximum output power under transmission mode and specific channel frequency

2.6 GENERAL DESCRIPTION OF APPLIED STANDARDS

The EUT is a RF product. According to the specifications of the manufacturer, it must comply with the requirements of the following standards:

FCC 47 CFR Part 2

FCC 47 CFR Part 24

KDB 971168 D01 Power Meas License Digital Systems v03r01

ANSI/TIA/EIA-603-D

ANSI/TIA/EIA-603-E

ANSI C63.26-2015

NOTE: All test items have been performed and recorded as per the above standards.



3 TEST TYPES AND RESULTS

3.1 OUTPUT POWER MEASUREMENT

3.1.1 LIMITS OF OUTPUT POWER MEASUREMENT

Mobile and portable stations are limited to 2 watts EIRP.

3.1.2 TEST PROCEDURES

EIRP MEASUREMENT:

- a. All measurements were done at low, middle and high operational frequency range. RBW and VBW is 10MHz for LTE mode.
- b. Substitution method is used for E.I.R.P measurement. In the semi-anechoic chamber, EUT placed on the 0.8m height of Turn Table, rotated the table around 360 degrees to search the maximum radiation power and receiver antenna shall be rotated vertical and horizontal polarization and moved height from 1m to 4m to find the maximum polar radiated power. The “Read Value” is the spectrum reading the maximum power value.
- c. The substitution horn antenna is substituted for EUT at the same position and signals generator export the CW signal to the substitution antenna via a tx cable. Rotated the Turn Table and moved receiving antenna to find the maximum radiation power. Adjust output power level of S.G to get a Value of spectrum reading equal to “Read Value “ of step b. Record the power level of S.G
- d. $EIRP = \text{Output power level of S.G} - \text{TX cable loss} + \text{Antenna gain of substitution horn}.$

CONDUCTED POWER MEASUREMENT:

The EUT was set up for the maximum power with GSM, GPRS, EDGE & WCDMA link data modulation and link up with simulator. Set the EUT to transmit under low, middle and high channel and record the power level shown on simulator.

3.1.3 TEST SETUP

EIRP / ERP Measurement:

<Radiated Emission below or equal 1 GHz>

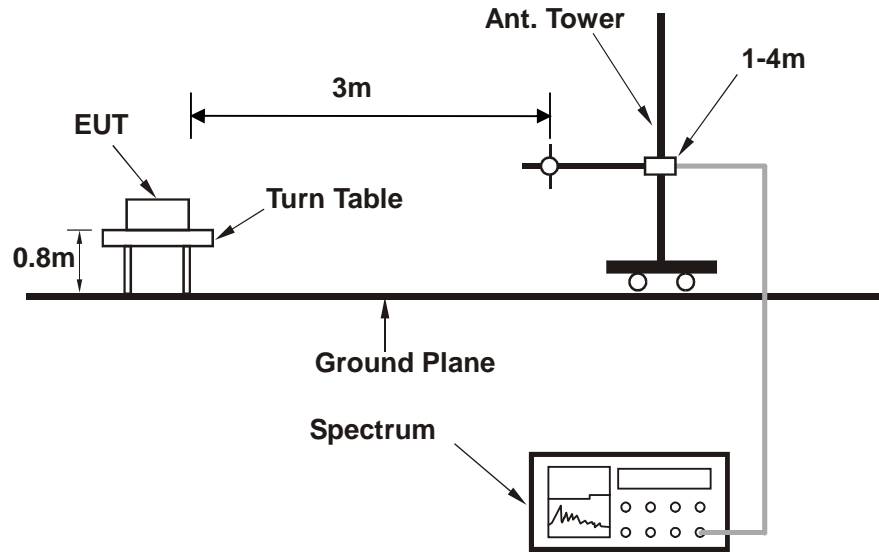

<Radiated Emission above 1 GHz>

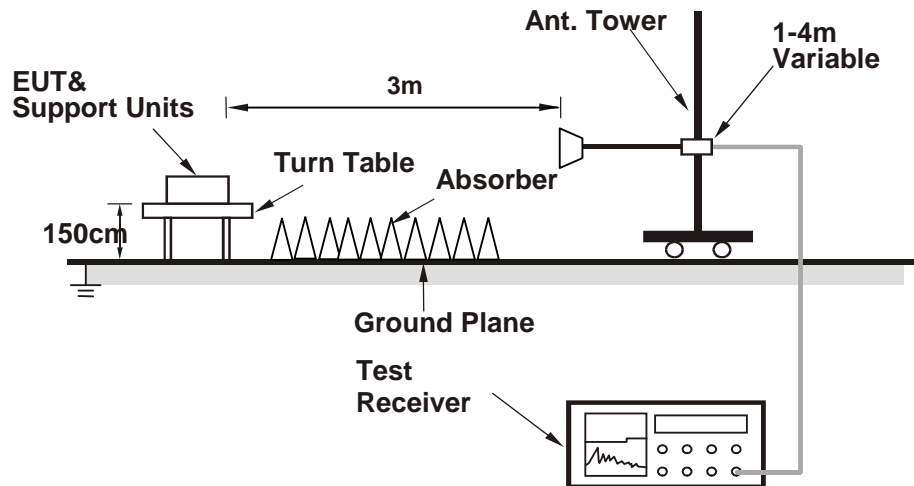

For the actual test configuration, please refer to the attached file (Test Setup Photo).

CONDUCTED POWER MEASUREMENT:

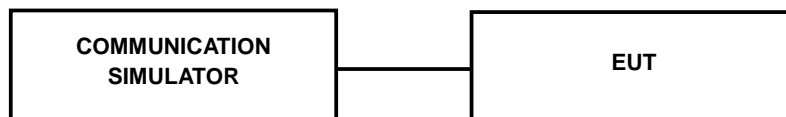



3.1.4 TEST RESULTS

CONDUCTED OUTPUT POWER (dBm)

The test results was recorded in Report No.:SD72128174-0517B.

EIRP POWER (dBm)

LTE BAND 2

CHANNEL BANDWIDTH: 1.4MHz QPSK

Channel	Frequency (MHz)	SPA LVL (dBm)	Correction Factor(dB)	EIRP(dBm)	EIRP(mW)	Polarization (H/V)	LIMIT (W)
18607	1850.7	-13.52	43.83	30.31	1074.98	H	2
18900	1880.0	-13.54	43.57	30.03	1006.93	H	2
19193	1909.3	-15.37	44.32	28.95	785.05	H	2
18607	1850.7	-22.97	46.41	23.44	220.85	V	2
18900	1880.0	-23.62	47.07	23.45	221.31	V	2
19193	1909.3	-24.52	45.88	21.36	136.90	V	2

CHANNEL BANDWIDTH: 1.4MHz 16QAM

Channel	Frequency (MHz)	SPA LVL (dBm)	Correction Factor(dB)	EIRP(dBm)	EIRP(mW)	Polarization (H/V)	LIMIT (W)
18607	1850.7	-14.39	43.83	29.44	879.83	H	2
18900	1880.0	-14.47	43.57	29.10	812.83	H	2
19193	1909.3	-16.33	44.32	27.99	629.36	H	2
18607	1850.7	-23.84	46.41	22.57	180.76	V	2
18900	1880.0	-24.55	47.07	22.52	178.65	V	2
19193	1909.3	-25.48	45.88	20.40	109.75	V	2

CHANNEL BANDWIDTH: 3MHz QPSK

Channel	Frequency (MHz)	SPA LVL (dBm)	Correction Factor(dB)	EIRP(dBm)	EIRP(mW)	Polarization (H/V)	LIMIT (W)
18615	1851.5	-13.50	43.82	30.32	1076.96	H	2
18900	1880.0	-13.60	43.57	29.97	993.12	H	2
19185	1908.5	-15.32	44.38	29.06	804.64	H	2
18615	1851.5	-22.95	46.45	23.50	223.92	V	2
18900	1880.0	-23.68	47.07	23.39	218.27	V	2
19185	1908.5	-24.47	45.88	21.41	138.36	V	2

CHANNEL BANDWIDTH: 3MHz 16QAM

Channel	Frequency (MHz)	SPA LVL (dBm)	Correction Factor(dB)	EIRP(dBm)	EIRP(mW)	Polarization (H/V)	LIMIT (W)
18615	1851.5	-14.57	43.82	29.25	841.78	H	2
18900	1880.0	-14.49	43.57	29.08	809.10	H	2
19185	1908.5	-16.31	44.38	28.07	640.62	H	2
18615	1851.5	-24.02	46.45	22.43	175.02	V	2
18900	1880.0	-24.57	47.07	22.50	177.83	V	2
19185	1908.5	-25.46	45.88	20.42	110.15	V	2

CHANNEL BANDWIDTH: 5MHz QPSK

Channel	Frequency (MHz)	SPA LVL (dBm)	Correction Factor(dB)	EIRP(dBm)	EIRP(mW)	Polarization (H/V)	LIMIT (W)
18625	1852.5	-13.56	43.83	30.27	1063.65	H	2
18900	1880.0	-13.55	43.57	30.02	1004.62	H	2
19175	1907.5	-15.27	44.19	28.92	779.47	H	2
18625	1852.5	-23.01	46.46	23.45	221.46	V	2
18900	1880.0	-23.63	47.07	23.44	220.80	V	2
19175	1907.5	-24.42	45.89	21.47	140.31	V	2



CHANNEL BANDWIDTH: 5MHz 16QAM

Channel	Frequency (MHz)	SPA LVL (dBm)	Correction Factor(dB)	EIRP(dBm)	EIRP(mW)	Polarization (H/V)	LIMIT (W)
18625	1852.5	-14.39	43.83	29.44	878.62	H	2
18900	1880.0	-14.57	43.57	29.00	794.33	H	2
19175	1907.5	-16.37	44.19	27.82	605.06	H	2
18625	1852.5	-23.84	46.46	22.62	182.94	V	2
18900	1880.0	-24.65	47.07	22.42	174.58	V	2
19175	1907.5	-25.52	45.89	20.37	108.92	V	2

CHANNEL BANDWIDTH: 10MHz QPSK

Channel	Frequency (MHz)	SPA LVL (dBm)	Correction Factor(dB)	EIRP(dBm)	EIRP(mW)	Polarization (H/V)	LIMIT (W)
18650	1855.0	-13.37	43.86	30.49	1119.70	H	2
18900	1880.0	-13.49	43.57	30.08	1018.59	H	2
19150	1905.0	-15.14	43.99	28.85	768.07	H	2
18650	1855.0	-22.82	46.28	23.46	221.72	V	2
18900	1880.0	-23.57	47.07	23.50	223.87	V	2
19150	1905.0	-24.29	45.92	21.63	145.61	V	2

CHANNEL BANDWIDTH: 10MHz 16QAM

Channel	Frequency (MHz)	SPA LVL (dBm)	Correction Factor(dB)	EIRP(dBm)	EIRP(mW)	Polarization (H/V)	LIMIT (W)
18650	1855.0	-14.52	43.86	29.34	859.21	H	2
18900	1880.0	-14.59	43.57	28.98	790.68	H	2
19150	1905.0	-16.30	43.99	27.69	588.03	H	2
18650	1855.0	-23.97	46.28	22.31	170.14	V	2
18900	1880.0	-24.67	47.07	22.40	173.78	V	2
19150	1905.0	-25.45	45.92	20.47	111.48	V	2



CHANNEL BANDWIDTH: 15MHz QPSK

Channel	Frequency (MHz)	SPA LVL (dBm)	Correction Factor(dB)	EIRP(dBm)	EIRP(mW)	Polarization (H/V)	LIMIT (W)
18675	1857.5	-12.38	43.99	31.61	1449.44	H	2
18900	1880.0	-13.56	43.57	30.01	1002.31	H	2
19125	1902.5	-15.21	43.66	28.45	699.04	H	2
18675	1857.5	-22.83	45.93	23.10	204.03	V	2
18900	1880.0	-23.64	47.07	23.43	220.29	V	2
19125	1902.5	-24.36	46.20	21.84	152.83	V	2

CHANNEL BANDWIDTH: 15MHz 16QAM

Channel	Frequency (MHz)	SPA LVL (dBm)	Correction Factor(dB)	EIRP(dBm)	EIRP(mW)	Polarization (H/V)	LIMIT (W)
18675	1857.5	-14.24	43.99	29.75	944.50	H	2
18900	1880.0	-14.43	43.57	29.14	820.35	H	2
19125	1902.5	-16.06	43.66	27.60	574.78	H	2
18675	1857.5	-23.69	45.93	22.24	167.38	V	2
18900	1880.0	-24.51	47.07	22.56	180.30	V	2
19125	1902.5	-25.21	46.20	20.99	125.66	V	2

CHANNEL BANDWIDTH: 20MHz QPSK

Channel	Frequency (MHz)	SPA LVL (dBm)	Correction Factor(dB)	EIRP(dBm)	EIRP(mW)	Polarization (H/V)	LIMIT (W)
18700	1860.0	-13.96	43.50	29.54	899.29	H	2
18900	1880.0	-14.01	43.57	29.56	903.65	H	2
19100	1900.0	-15.79	43.62	27.83	606.18	H	2
18700	1860.0	-23.41	45.57	22.16	164.44	V	2
18900	1880.0	-24.09	47.07	22.98	198.61	V	2
19100	1900.0	-24.94	46.26	21.32	135.55	V	2



CHANNEL BANDWIDTH: 20MHz 16QAM

Channel	Frequency (MHz)	SPA LVL (dBm)	Correction Factor(dB)	EIRP(dBm)	EIRP(mW)	Polarization (H/V)	LIMIT (W)
18700	1860.0	-14.89	43.50	28.61	725.94	H	2
18900	1880.0	-15.08	43.57	28.49	706.32	H	2
19100	1900.0	-16.62	43.62	27.00	500.73	H	2
18700	1860.0	-24.34	45.57	21.23	132.74	V	2
18900	1880.0	-25.16	47.07	21.91	155.24	V	2
19100	1900.0	-25.77	46.26	20.49	111.97	V	2

REMARKS: 1. EIRP Output Power (dBm) = SPA LVL (dBm) + Correction Factor (dB).

2. Correction factor (dB) = Free Space Loss + Antenna Factor + Cable Loss



3.2 FREQUENCY STABILITY MEASUREMENT

3.2.1 LIMITS OF FREQUENCY STABILITY MEASUREMENT

The frequency stability shall be sufficient to ensure that the fundamental emission stays within the authorized frequency block.

3.2.2 TEST PROCEDURE

- a. Device is placed at the oven room. The oven room could control the temperatures and humidity. Power warm up is at least 15 min and power applied should perform before recording frequency error.
- b. EUT is connected the external power supply to control the DC input power. The test voltage range is from minimum to maximum working voltage. Each step shall be record the frequency error rate.
- c. The temperature range step is 10 degrees in this test items. All temperature levels shall be hold the $\pm 0.5^{\circ}\text{C}$ during the measurement testing. The each temperature step shall be at least 0.5 hours, consider the EUT could be test under the stability condition.

NOTE: The frequency error was recorded frequency error from the communication simulator.

3.2.3 TEST SETUP

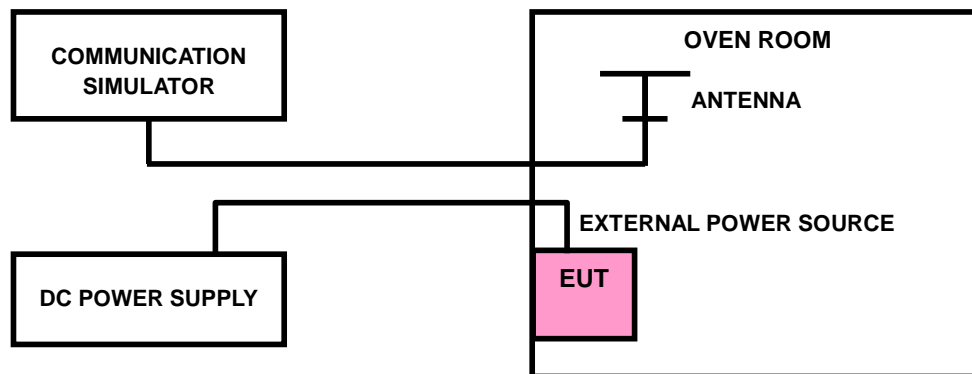

3.2.4 TEST RESULTS

The test results was recorded in Report No.:SD72128174-0517B.



3.3 OCCUPIED BANDWIDTH MEASUREMENT

3.3.1 TEST PROCEDURES

The EUT makes a call to the communication simulator. All measurements were done at low, middle and high operational frequency range. The communication simulator station system controlled a EUT to export maximum output power under transmission mode and specific channel frequency. Use OBW measurement function of Spectrum analyzer to measure 99 % occupied bandwidth.

3.3.2 TEST SETUP

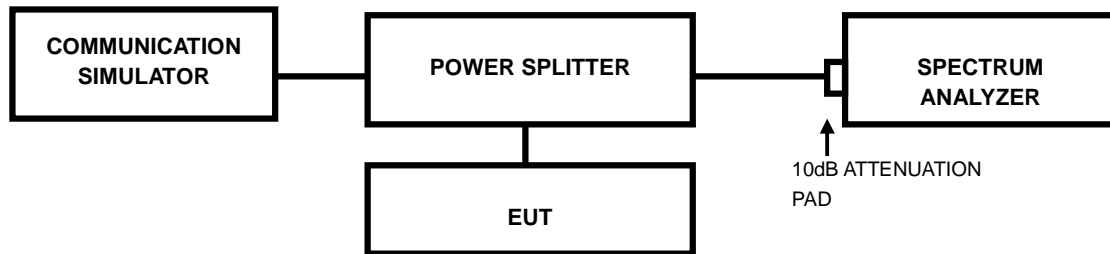

3.3.3 TEST RESULTS

The test results was recorded in Report No.:SD72128174-0517B.



3.4 BAND EDGE MEASUREMENT

3.4.1 LIMITS OF BAND EDGE MEASUREMENT

Power of any emission outside of the authorized operating frequency ranges must be attenuated below the transmitting power (P) by a factor of at least $43 + 10 \log(P)$ dB. In the 1 MHz bands immediately outside and adjacent to the frequency block a resolution bandwidth of at least one percent of the emission bandwidth of the fundamental emission of the transmitter may be employed.

3.4.2 TEST SETUP

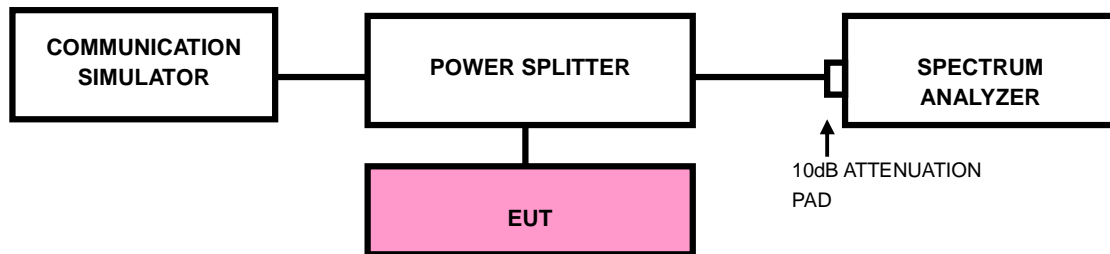

3.4.3 TEST PROCEDURES

- a. All measurements were done at low and high operational frequency range.
- b. The center frequency of spectrum is the band edge frequency and span is 1~5 MHz. RBW of the spectrum is 20kHz and VBW of the spectrum is 100 kHz. (LTE bandwidth 1.4MHz)
- c. The center frequency of spectrum is the band edge frequency and span is 1~5 MHz. RBW of the spectrum is 30kHz and VBW of the spectrum is 100kHz. (LTE bandwidth 3MHz)
- d. The center frequency of spectrum is the band edge frequency and span is 1~5 MHz. RBW of the spectrum is 50kHz and VBW of the spectrum is 200kHz. (LTE bandwidth 5MHz)
- e. The center frequency of spectrum is the band edge frequency and span is 1~5 MHz. RBW of the spectrum is 100kHz and VBW of the spectrum is 300kHz. (LTE bandwidth 10MHz)
- f. The center frequency of spectrum is the band edge frequency and span is 1~5 MHz. RBW of the spectrum is 200kHz and VBW of the spectrum is 1MHz. (LTE bandwidth 15MHz)
- g. The center frequency of spectrum is the band edge frequency and span is 1~5 MHz. RBW of the spectrum is 200kHz and VBW of the spectrum is 1MHz. (LTE bandwidth 20MHz)
- h. Record the max trace plot into the test report.

3.4.4. TEST RESULTS

The test results was recorded in Report No.:SD72128174-0517B.



3.5 CONDUCTED SPURIOUS EMISSIONS

3.5.1 LIMITS OF CONDUCTED SPURIOUS EMISSIONS MEASUREMENT

The power of any emission outside of the authorized operating frequency ranges must be attenuated below the transmitting power (P) by a factor of at least $43 + 10 \log(P)$ dB. The emission limit equal to -13dBm .

3.5.2 TEST PROCEDURE

- a. The EUT makes a phone call to the communication simulator. All measurements were done at low, middle and high operational frequency range.
- b. Measuring frequency range is from 9 kHz to 19.1GHz. 10dB attenuation pad is connected with spectrum. RBW=1MHz and VBW=3MHz is used for conducted emission measurement.

3.5.3 TEST SETUP

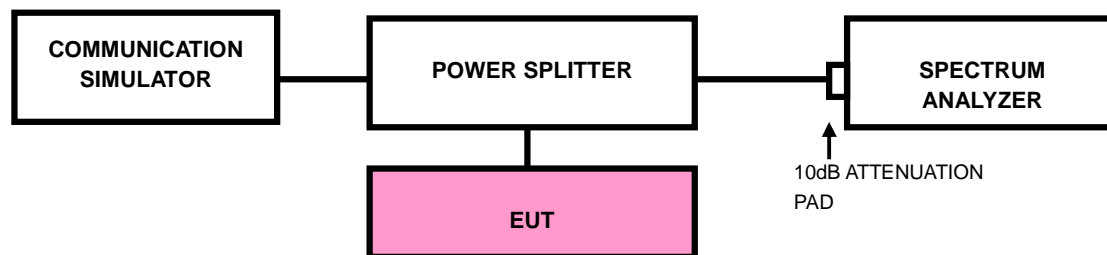

3.5.4 TEST RESULTS

The test results was recorded in Report No.:SD72128174-0517B.

3.6 RADIATED EMISSION MEASUREMENT

3.6.1 LIMITS OF RADIATED EMISSION MEASUREMENT

The power of any emission outside of the authorized operating frequency ranges must be attenuated below the transmitting power (P) by a factor of at least $43 + 10 \log(P)$ dB. The emission limit equal to -13dBm .

3.6.2 TEST PROCEDURES

- a. Substitution method is used for E.I.R.P measurement. In the semi-anechoic chamber, EUT placed on the 0.8m height of Turn Table, rotated the table around 360 degrees to search the maximum radiation power and receiver antenna shall be rotated vertical and horizontal polarization and moved height from 1m to 4m to find the maximum polar radiated power. The “Read Value” is the spectrum reading the maximum power value.
- b. The substitution horn antenna is substituted for EUT at the same position and signals generator export the CW signal to the substitution antenna via a TX cable. Rotated the Turn Table and moved receiving antenna to find the maximum radiation power. Adjust output power level of S.G to get a Value of spectrum reading equal to “Read Value “ of step a. Record the power level of S.G
- c. EIRP = Output power level of S.G - TX cable loss + Antenna gain of substitution horn.

NOTE: The resolution bandwidth and video bandwidth of test receiver/spectrum analyzer is 1MHz/3MHz.

3.6.3 DEVIATION FROM TEST STANDARD

No deviation



3.6.4 TEST SETUP

<Below 30MHz>

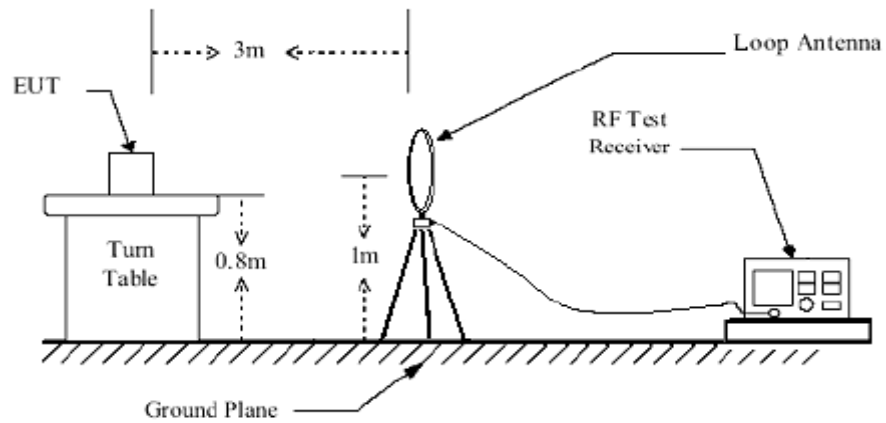

< Frequency Range 30MHz~1GHz >

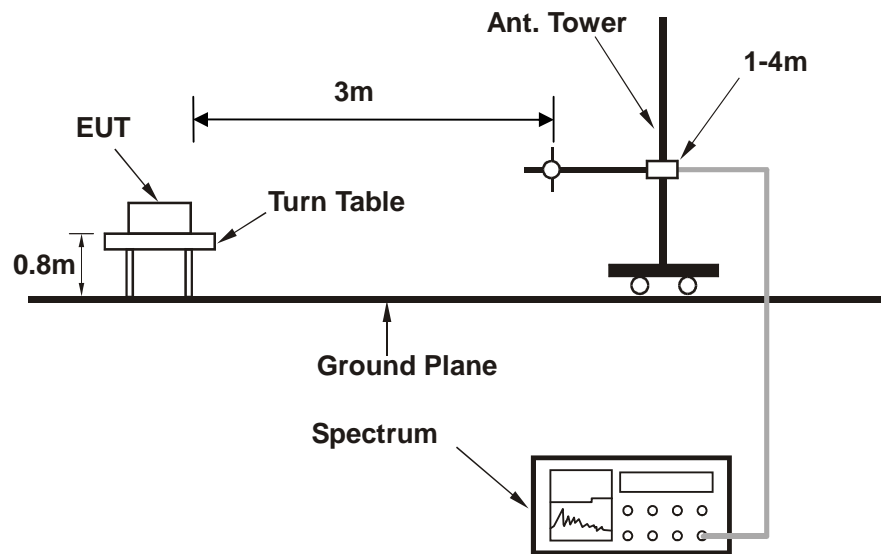



< Frequency Range above 1GHz >

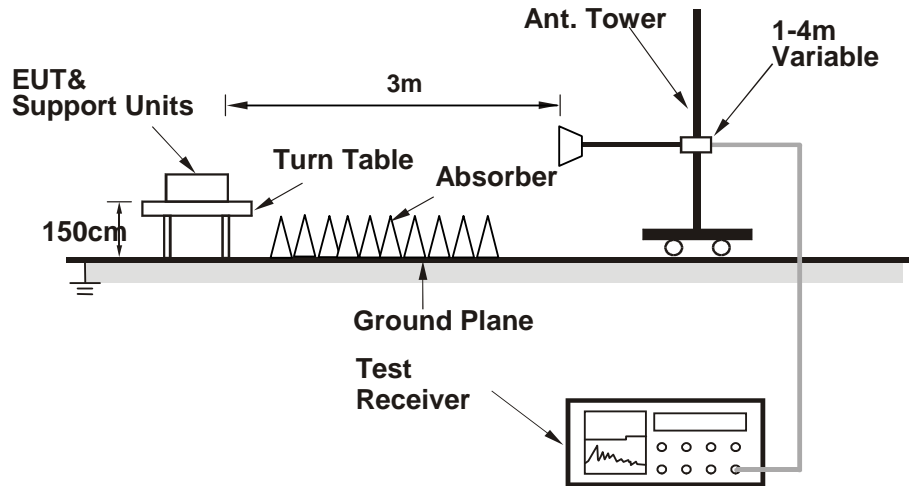

For the actual test configuration, please refer to the attached file (Test Setup Photo).



3.6.5 TEST RESULTS

BELOW 1GHz WORST-CASE DATA

9 KHz – 30 MHz data: the amplitude of spurious emissions attenuated more than 20 dB below the permissible value is not required in the report.

30 MHz – 1GHz data:

LTE Band 2:

MODE	TX channel 18900	FREQUENCY RANGE	Below 1000MHz
ENVIRONMENTAL CONDITIONS	23deg. C, 70%RH	INPUT POWER	DC 5V from adapter
TESTED BY	Star Le		
ANTENNA POLARITY & TEST DISTANCE: HORIZONTAL AT 3 M			

		Freq	Level	Read Level	Limit Line	Over Limit	Factor	Remark	Pol/Phase
		MHz	dBm/m	dBm	dBm/m	dB	dB/m		
1	PP	32.850	-30.70	-46.12	-13.00	-17.70	15.42	Peak	Horizontal
2		65.460	-46.56	-36.56	-13.00	-33.56	-10.00	Peak	Horizontal
3		70.120	-55.56	-43.25	-13.00	-42.56	-12.31	Peak	Horizontal
4		156.240	-52.59	-33.87	-13.00	-39.59	-18.72	Peak	Horizontal
5		235.410	-43.82	-27.26	-13.00	-30.82	-16.56	Peak	Horizontal
6		245.680	-52.08	-35.72	-13.00	-39.08	-16.36	Peak	Horizontal

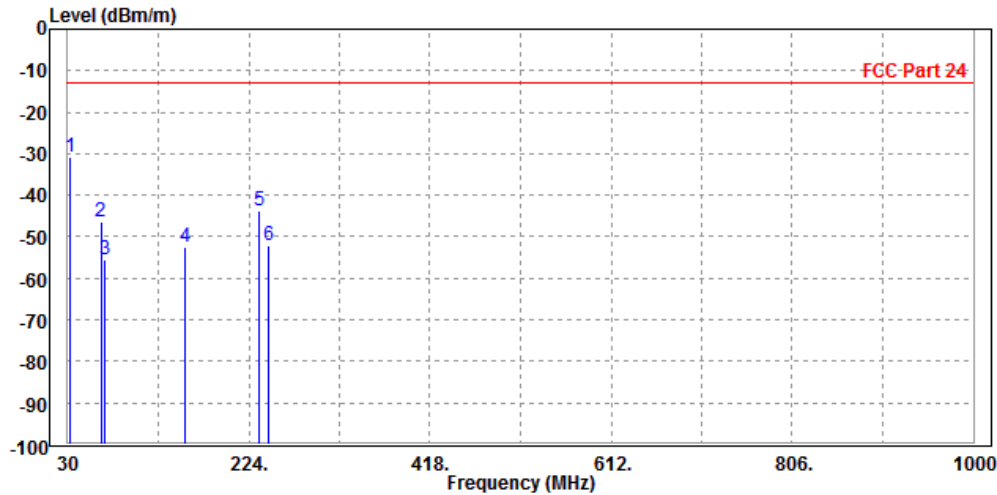



**BUREAU
VERITAS**

Test Report No.: RF181008W004-2

MODE	TX channel 18900	FREQUENCY RANGE	Below 1000MHz
ENVIRONMENTAL CONDITIONS	23deg. C, 70%RH	INPUT POWER	DC 5V from adapter
TESTED BY	Star Le		
ANTENNA POLARITY & TEST DISTANCE: VERTICAL AT 3 M			

	Freq	Level	Read Level	Limit Line	Over Limit	Factor	Remark	Pol/Phase	
	MHz	dBm/m	dBm	dBm/m	dB	dB/m			
1	PP	38.170	-37.85	-36.56	-13.00	-24.85	-1.29	Peak	Vertical
2		88.780	-47.98	-37.48	-13.00	-34.98	-10.50	Peak	Vertical
3		101.440	-53.70	-42.84	-13.00	-40.70	-10.86	Peak	Vertical
4		179.000	-43.38	-30.11	-13.00	-30.38	-13.27	Peak	Vertical
5		259.420	-45.63	-34.15	-13.00	-32.63	-11.48	Peak	Vertical
6		301.810	-61.77	-50.48	-13.00	-48.77	-11.29	Peak	Vertical

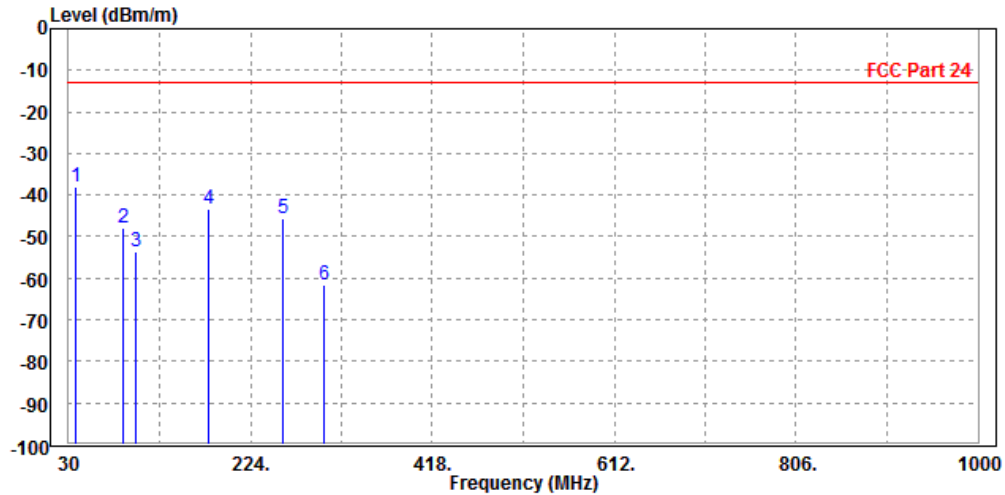



ABOVE 1GHz DATA

Note: For higher frequency, the emission is too low to be detected.

LTE Band 2

CHANNEL BANDWIDTH: 1.4MHz / QPSK

MODE	TX channel 18900	FREQUENCY RANGE	Above 1000MHz
ENVIRONMENTAL CONDITIONS	23deg. C, 70%RH	INPUT POWER	DC 5V from adapter
TESTED BY	Star Le		
ANTENNA POLARITY & TEST DISTANCE: HORIZONTAL AT 3 M			

	Freq	Level	Read Level	Limit Line	Over Limit	Factor	Remark	Pol/Phase
	MHz	dBm/m	dBm	dBm/m	dB	dB/m		
1 PP	3755.000	-40.40	-43.79	-13.00	-27.40	3.39	Peak	Horizontal
2	5640.000	-51.23	-60.35	-13.00	-38.23	9.12	Peak	Horizontal

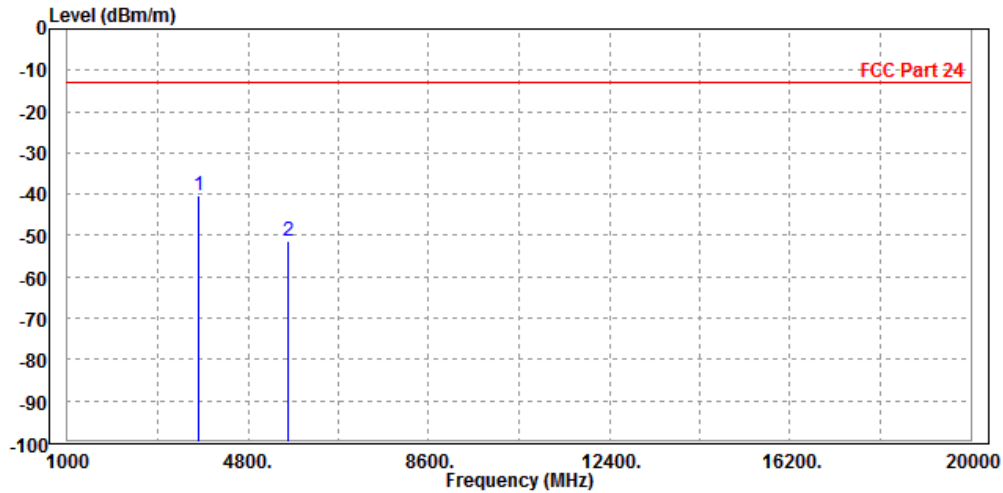



**BUREAU
VERITAS**

Test Report No.: RF181008W004-2

MODE	TX channel 18900	FREQUENCY RANGE	Above 1000MHz
ENVIRONMENTAL CONDITIONS	23deg. C, 70%RH	INPUT POWER	DC 5V from adapter
TESTED BY	Star Le		
ANTENNA POLARITY & TEST DISTANCE: VERTICAL AT 3 M			

	Read	Limit	Over			
Freq	Level	Level	Line	Limit	Factor	Remark
MHz	dBm/m	dBm	dBm/m	dB	dB/m	Pol/Phase
1 PP 3755.000	-40.79	-44.64	-13.00	-27.79	3.85	Peak Vertical
2 5640.000	-49.32	-57.58	-13.00	-36.32	8.26	Peak Vertical

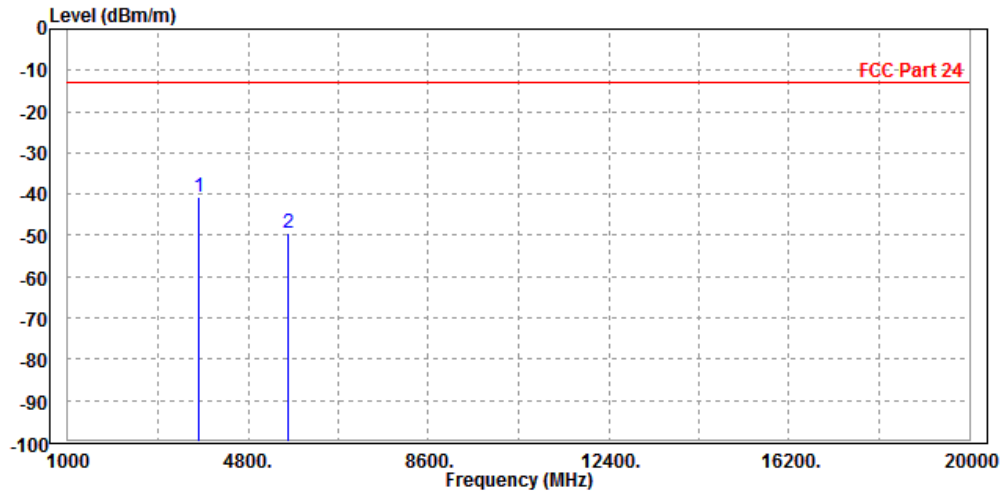



CHANNEL BANDWIDTH: 3MHz / QPSK

MODE	TX channel 18900	FREQUENCY RANGE	Above 1000MHz
ENVIRONMENTAL CONDITIONS	23deg. C, 70%RH	INPUT POWER	DC 5V from adapter
TESTED BY	Star Le		
ANTENNA POLARITY & TEST DISTANCE: HORIZONTAL AT 3 M			

	Freq	Level	Read Level	Limit Line	Over Limit	Factor	Remark	Pol/Phase
	MHz	dBm/m	dBm	dBm/m	dB	dB/m		
1	PP 3755.000	-40.86	-44.25	-13.00	-27.86	3.39	Peak	Horizontal
2	5640.000	-47.14	-56.26	-13.00	-34.14	9.12	Peak	Horizontal

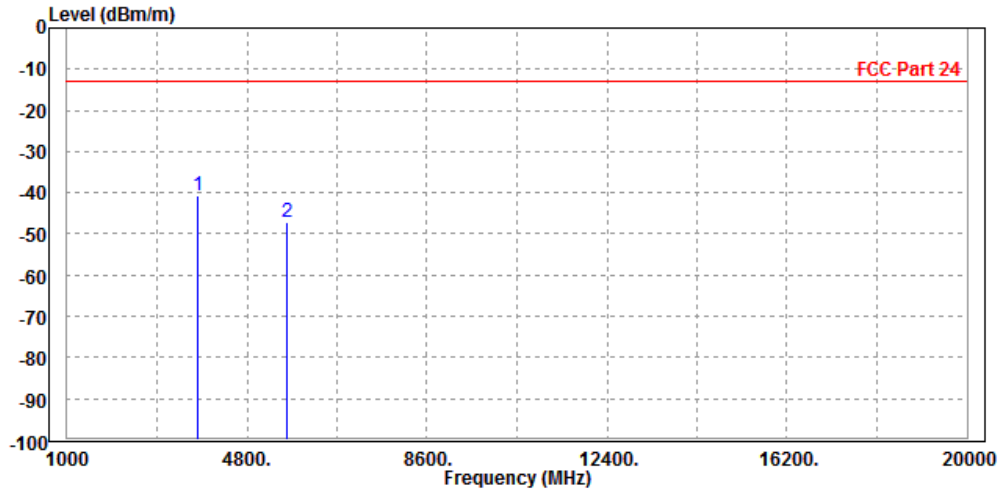



BUREAU
VERITAS

Test Report No.: RF181008W004-2

MODE	TX channel 18900	FREQUENCY RANGE	Above 1000MHz
ENVIRONMENTAL CONDITIONS	23deg. C, 70%RH	INPUT POWER	DC 5V from adapter
TESTED BY	Star Le		
ANTENNA POLARITY & TEST DISTANCE: VERTICAL AT 3 M			

		Read	Limit	Over			
	Freq	Level	Level	Line	Limit	Factor	Remark
	MHz	dBm/m	dBm	dBm/m	dB	dB/m	Pol/Phase
1	PP 3755.000	-39.72	-43.57	-13.00	-26.72	3.85	Peak Vertical
2	5640.000	-49.20	-57.46	-13.00	-36.20	8.26	Peak Vertical

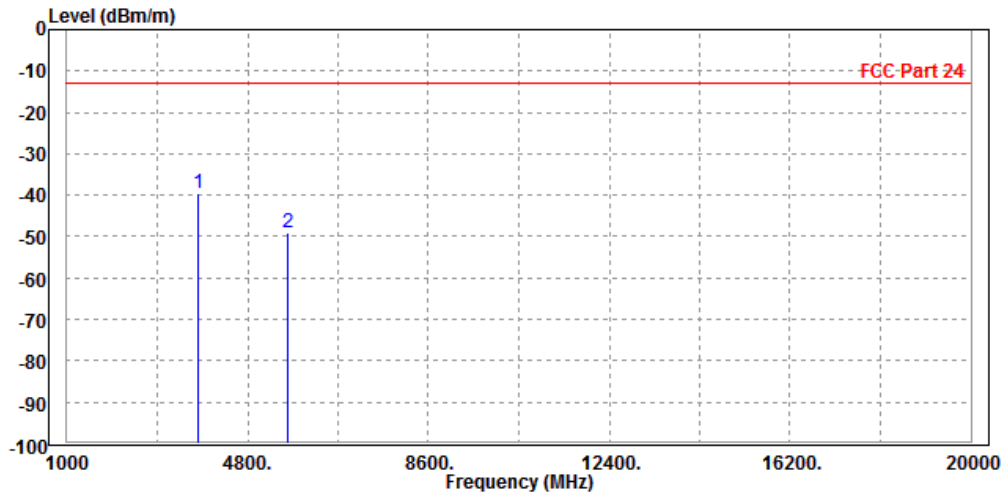



CHANNEL BANDWIDTH: 5MHz / QPSK

MODE	TX channel 18900	FREQUENCY RANGE	Above 1000MHz
ENVIRONMENTAL CONDITIONS	23deg. C, 70%RH	INPUT POWER	DC 5V from adapter
TESTED BY	Star Le		
ANTENNA POLARITY & TEST DISTANCE: HORIZONTAL AT 3 M			

	Freq	Level	Read Level	Limit Line	Over Limit	Factor	Remark	Pol/Phase
	MHz	dBm/m	dBm	dBm/m	dB	dB/m		
1	PP 3755.000	-41.46	-44.85	-13.00	-28.46	3.39	Peak	Horizontal
2	5640.000	-48.40	-57.52	-13.00	-35.40	9.12	Peak	Horizontal

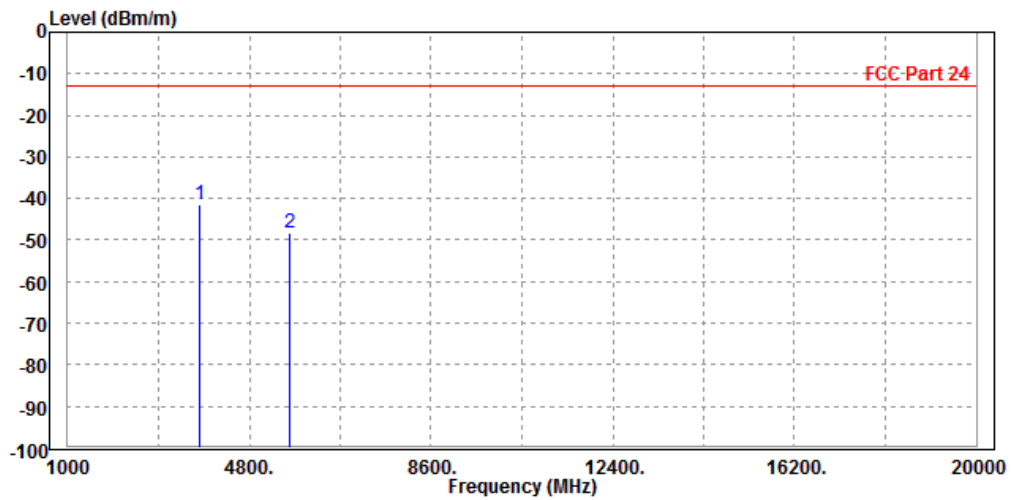



**BUREAU
VERITAS**

Test Report No.: RF181008W004-2

MODE	TX channel 18900	FREQUENCY RANGE	Above 1000MHz
ENVIRONMENTAL CONDITIONS	23deg. C, 70%RH	INPUT POWER	DC 5V from adapter
TESTED BY	Star Le		
ANTENNA POLARITY & TEST DISTANCE: VERTICAL AT 3 M			

	Freq	Level	Read Level	Limit Line	Over Limit	Factor	Remark	Pol/Phase
	MHz	dBm/m	dBm	dBm/m	dB	dB/m		
1	PP 3755.000	-44.83	-48.68	-13.00	-31.83	3.85	Peak	Vertical
2	5640.000	-50.19	-58.45	-13.00	-37.19	8.26	Peak	Vertical

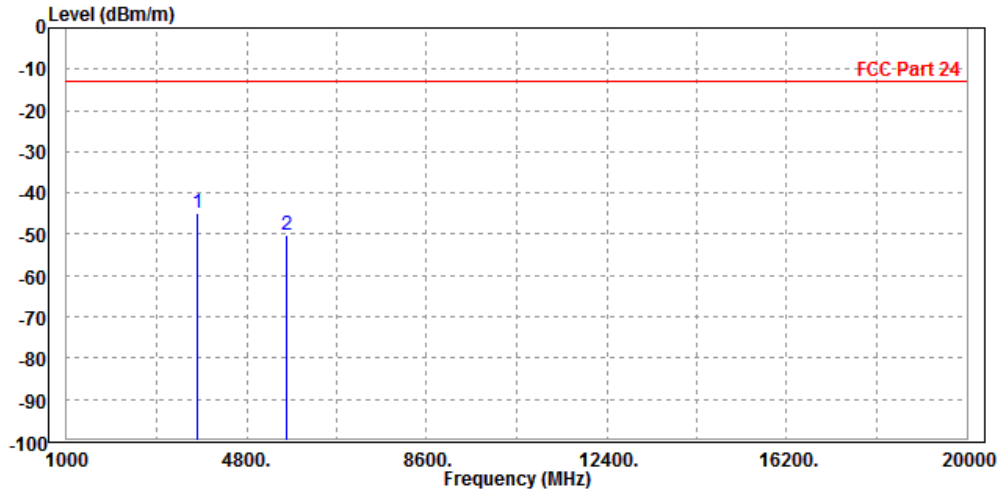



**BUREAU
VERITAS**

Test Report No.: RF181008W004-2

CHANNEL BANDWIDTH: 10MHz / QPSK

CH 18650

MODE	TX channel 18650	FREQUENCY RANGE	Above 1000MHz
ENVIRONMENTAL CONDITIONS	23deg. C, 70%RH	INPUT POWER	DC 5V from adapter
TESTED BY	Star Le		
ANTENNA POLARITY & TEST DISTANCE: HORIZONTAL AT 3 M			

	Freq	Level	Read Level	Limit Line	Over Limit	Factor	Remark	Pol/Phase
	MHz	dBm/m	dBm	dBm/m	dB	dB/m		
1	PP 3717.000	-39.63	-42.84	-13.00	-26.63	3.21	Peak	Horizontal
2	5565.000	-50.21	-59.25	-13.00	-37.21	9.04	Peak	Horizontal

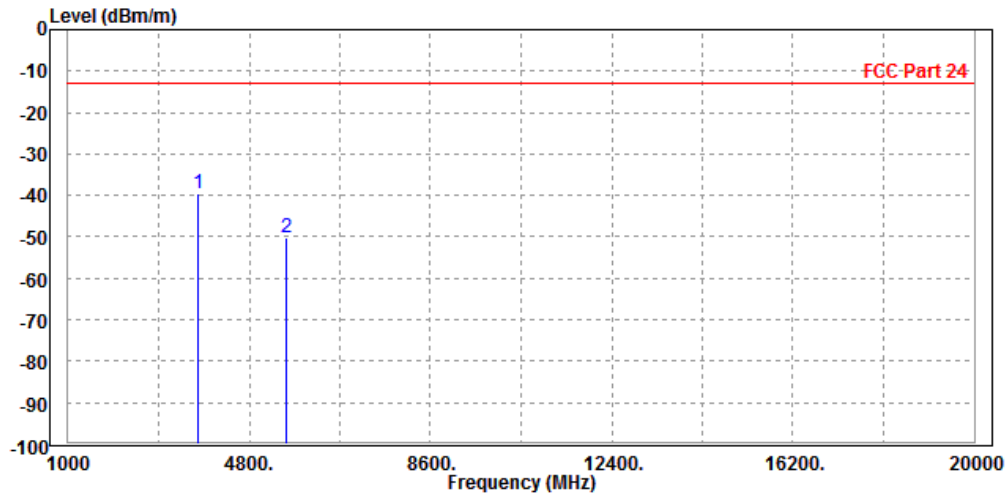



**BUREAU
VERITAS**

Test Report No.: RF181008W004-2

MODE	TX channel 18650	FREQUENCY RANGE	Above 1000MHz
ENVIRONMENTAL CONDITIONS	23deg. C, 70%RH	INPUT POWER	DC 5V from adapter
TESTED BY	Star Le		
ANTENNA POLARITY & TEST DISTANCE: VERTICAL AT 3 M			

	Freq	Level	Read Level	Limit Line	Over Limit	Factor	Remark	Pol/Phase
	MHz	dBm/m	dBm	dBm/m	dB	dB/m		
1	PP 3717.000	-38.63	-42.29	-13.00	-25.63	3.66	Peak	Vertical
2	5565.000	-49.61	-57.71	-13.00	-36.61	8.10	Peak	Vertical

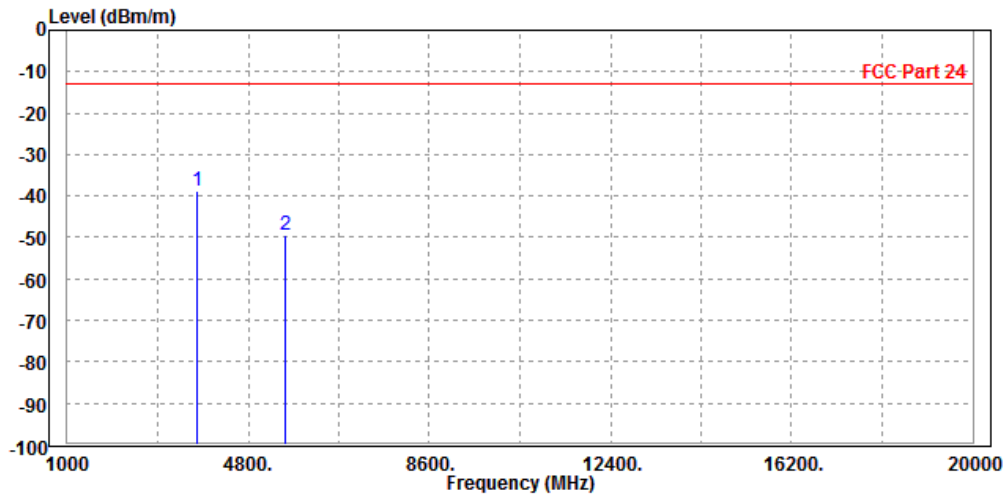



**BUREAU
VERITAS**

Test Report No.: RF181008W004-2

CH 18900

MODE	TX channel 18900	FREQUENCY RANGE	Above 1000MHz
ENVIRONMENTAL CONDITIONS	23deg. C, 70%RH	INPUT POWER	DC 5V from adapter
TESTED BY	Star Le		
ANTENNA POLARITY & TEST DISTANCE: HORIZONTAL AT 3 M			

	Freq	Level	Read Level	Limit Line	Over Limit	Factor	Remark	Pol/Phase
	MHz	dBm/m	dBm	dBm/m	dB	dB/m		
1	PP 3755.000	-38.85	-42.24	-13.00	-25.85	3.39	Peak	Horizontal
2	5640.000	-49.00	-58.12	-13.00	-36.00	9.12	Peak	Horizontal

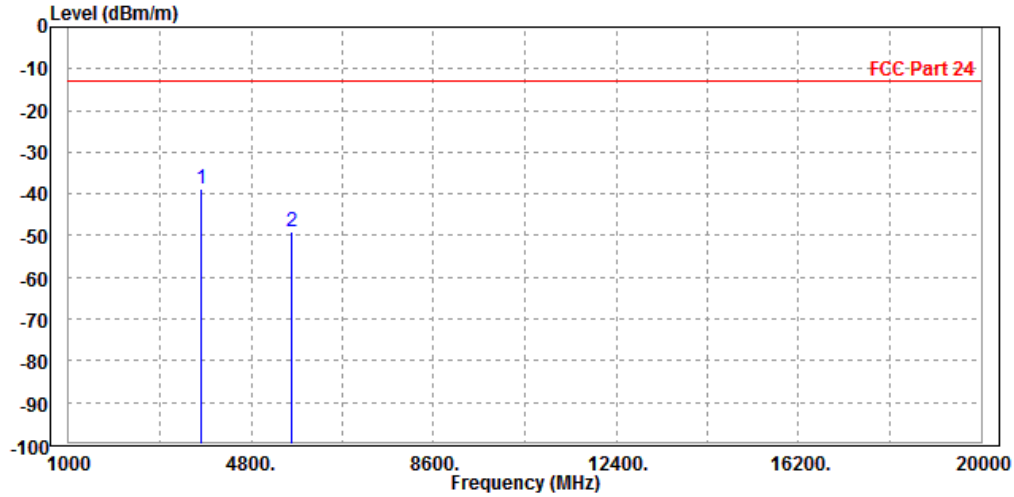



BUREAU
VERITAS

Test Report No.: RF181008W004-2

MODE	TX channel 18900	FREQUENCY RANGE	Above 1000MHz
ENVIRONMENTAL CONDITIONS	23deg. C, 70%RH	INPUT POWER	DC 5V from adapter
TESTED BY	Star Le		
ANTENNA POLARITY & TEST DISTANCE: VERTICAL AT 3 M			

	Freq	Level	Read Level	Limit Line	Over Limit	Factor	Remark	Pol/Phase
	MHz	dBm/m	dBm	dBm/m	dB	dB/m		
1	PP 3755.000	-40.41	-44.26	-13.00	-27.41	3.85	Peak	Vertical
2	5640.000	-47.19	-55.45	-13.00	-34.19	8.26	Peak	Vertical

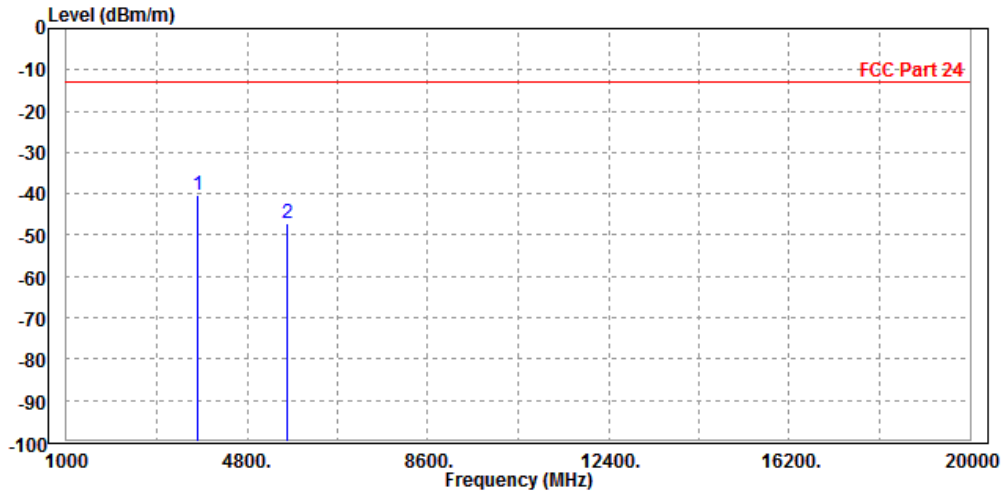



CH 19150

MODE	TX channel 19150	FREQUENCY RANGE	Above 1000MHz
ENVIRONMENTAL CONDITIONS	23deg. C, 70%RH	INPUT POWER	DC 5V from adapter
TESTED BY	Star Le		
ANTENNA POLARITY & TEST DISTANCE: HORIZONTAL AT 3 M			

	Freq	Level	Read Level	Limit Line	Over Limit	Factor	Remark	Pol/Phase
	MHz	dBm/m	dBm	dBm/m	dB	dB/m		
1	PP 3812.000	-39.70	-43.36	-13.00	-26.70	3.66	Peak	Horizontal
2	5715.000	-49.57	-58.78	-13.00	-36.57	9.21	Peak	Horizontal

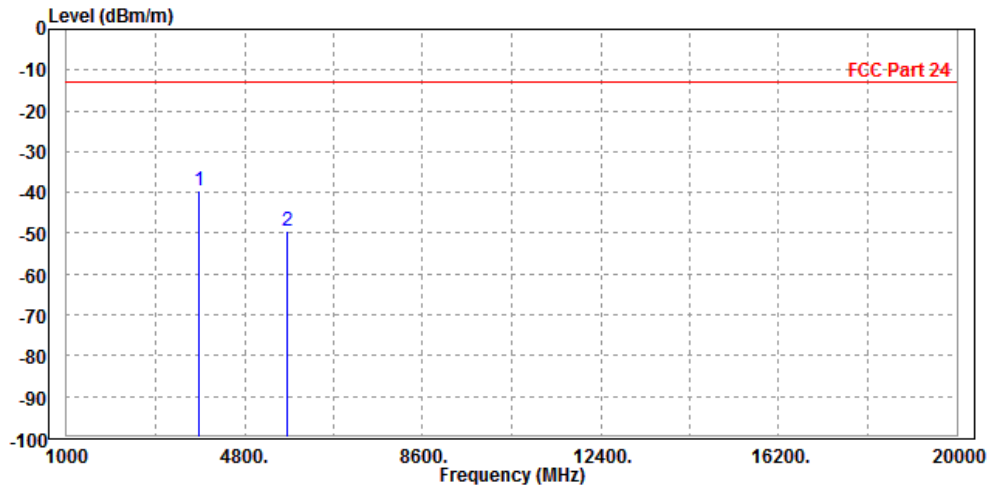



MODE	TX channel 19150	FREQUENCY RANGE	Above 1000MHz
ENVIRONMENTAL CONDITIONS	23deg. C, 70%RH	INPUT POWER	DC 5V from adapter
TESTED BY	Star Le		
ANTENNA POLARITY & TEST DISTANCE: VERTICAL AT 3 M			

	Read	Limit	Over				
Freq	Level	Level	Line	Limit	Factor	Remark	Pol/Phase
MHz	dBm/m	dBm	dBm/m	dB	dB/m		
1 PP 3812.000	-39.45	-43.59	-13.00	-26.45	4.14	Peak	Vertical
2 5715.000	-50.13	-58.54	-13.00	-37.13	8.41	Peak	Vertical

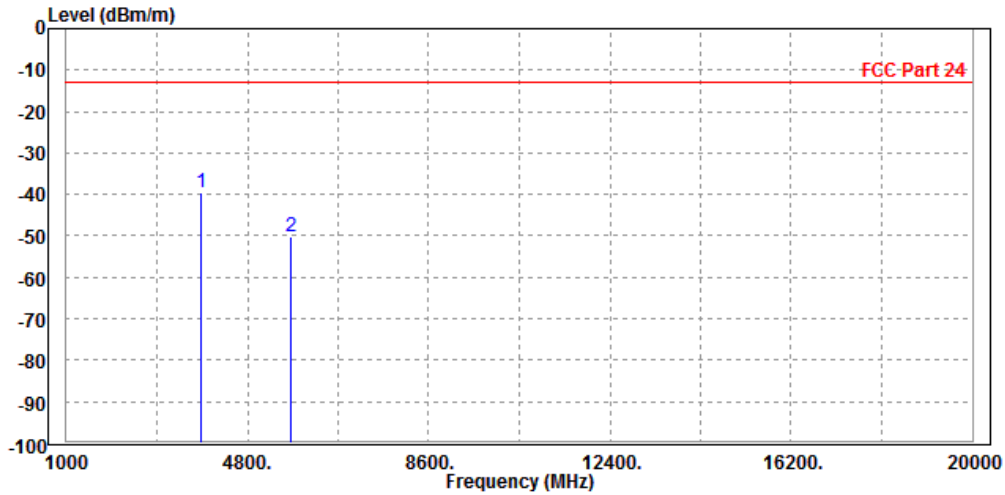



CHANNEL BANDWIDTH: 15MHz / QPSK

MODE	TX channel 18900	FREQUENCY RANGE	Above 1000MHz
ENVIRONMENTAL CONDITIONS	23deg. C, 70%RH	INPUT POWER	DC 5V from adapter
TESTED BY	Star Le		
ANTENNA POLARITY & TEST DISTANCE: HORIZONTAL AT 3 M			

	Freq	Level	Read Level	Limit Line	Over Limit	Factor	Remark	Pol/Phase
	MHz	dBm/m	dBm	dBm/m	dB	dB/m		
1	PP 3755.000	-40.18	-43.57	-13.00	-27.18	3.39	Peak	Horizontal
2	5640.000	-49.19	-58.31	-13.00	-36.19	9.12	Peak	Horizontal

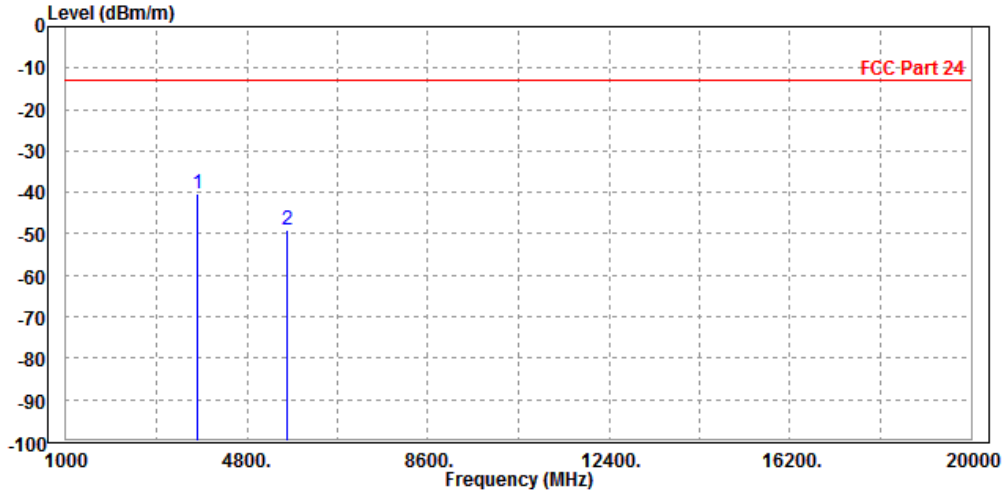



BUREAU
VERITAS

Test Report No.: RF181008W004-2

MODE	TX channel 18900	FREQUENCY RANGE	Above 1000MHz
ENVIRONMENTAL CONDITIONS	23deg. C, 70%RH	INPUT POWER	DC 5V from adapter
TESTED BY	Star Le		
ANTENNA POLARITY & TEST DISTANCE: VERTICAL AT 3 M			

		Read	Limit	Over				
	Freq	Level	Level	Line	Limit	Factor	Remark	Pol/Phase
	MHz	dBm/m	dBm	dBm/m	dB	dB/m		
1	PP 3755.000	-42.01	-45.86	-13.00	-29.01	3.85	Peak	Vertical
2	5640.000	-50.15	-58.41	-13.00	-37.15	8.26	Peak	Vertical

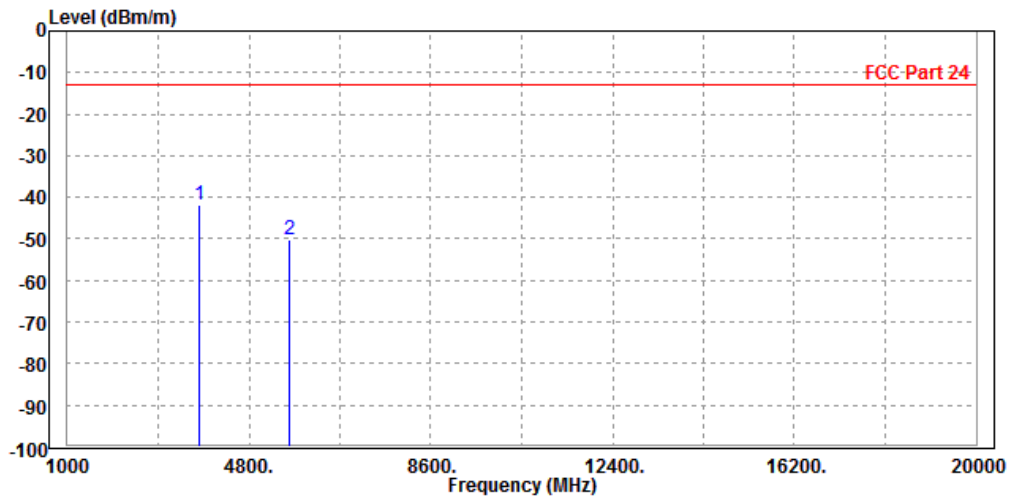



BUREAU VERITAS

Test Report No.: RF181008W004-2

CHANNEL BANDWIDTH: 20MHz / QPSK

MODE	TX channel 18900	FREQUENCY RANGE	Above 1000MHz
ENVIRONMENTAL CONDITIONS	23deg. C, 70%RH	INPUT POWER	DC 5V from adapter
TESTED BY	Star Le		
ANTENNA POLARITY & TEST DISTANCE: HORIZONTAL AT 3 M			

	Freq	Level	Read Level	Limit Line	Over Limit	Factor	Remark	Pol/Phase
	MHz	dBm/m	dBm	dBm/m	dB	dB/m		
1	PP 3755.000	-41.12	-44.51	-13.00	-28.12	3.39	Peak	Horizontal
2	5640.000	-49.83	-58.95	-13.00	-36.83	9.12	Peak	Horizontal

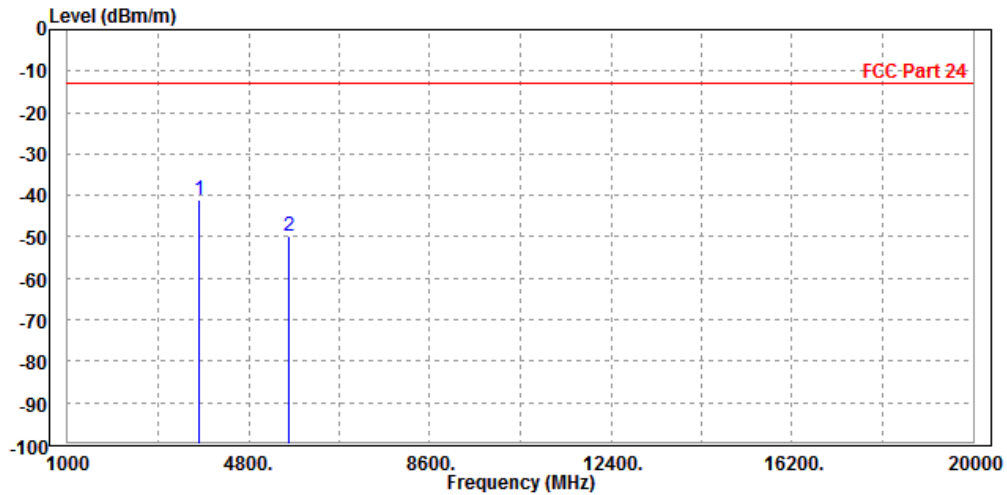



BUREAU
VERITAS

Test Report No.: RF181008W004-2

MODE	TX channel 18900	FREQUENCY RANGE	Above 1000MHz
ENVIRONMENTAL CONDITIONS	23deg. C, 70%RH	INPUT POWER	DC 5V from adapter
TESTED BY	Star Le		
ANTENNA POLARITY & TEST DISTANCE: VERTICAL AT 3 M			

	Read	Limit	Over				
Freq	Level	Level	Line	Limit	Factor	Remark	Pol/Phase
MHz	dBm/m	dBm	dBm/m	dB	dB/m		
1 PP 3755.000	-40.74	-44.59	-13.00	-27.74	3.85	Peak	Vertical
2 5640.000	-48.01	-56.27	-13.00	-35.01	8.26	Peak	Vertical

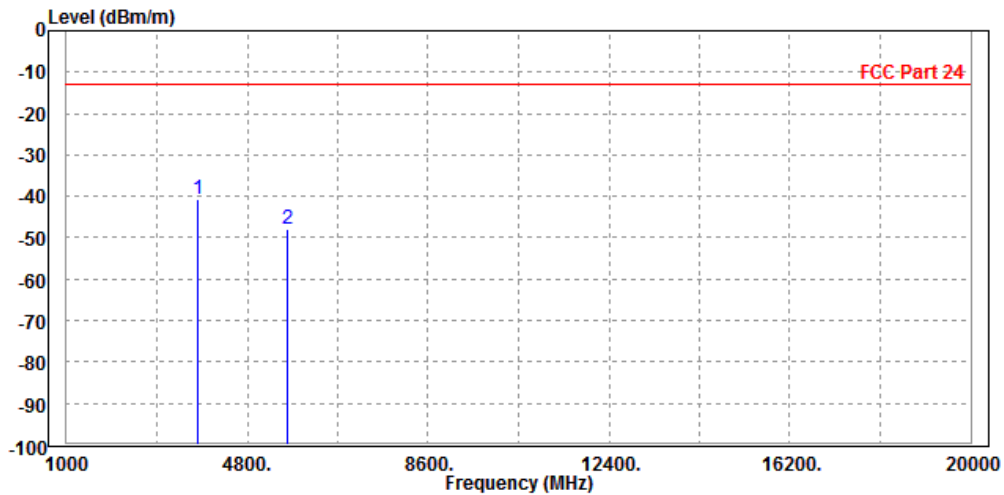



3.7 PEAK TO AVERAGE RATIO

3.7.1 LIMITS OF peak to average ratio MEASUREMENT

In measuring transmissions in this band using an average power technique, the peak to-average ratio (PAR) of the transmission may not exceed 13 dB

3.7.2 TEST SETUP

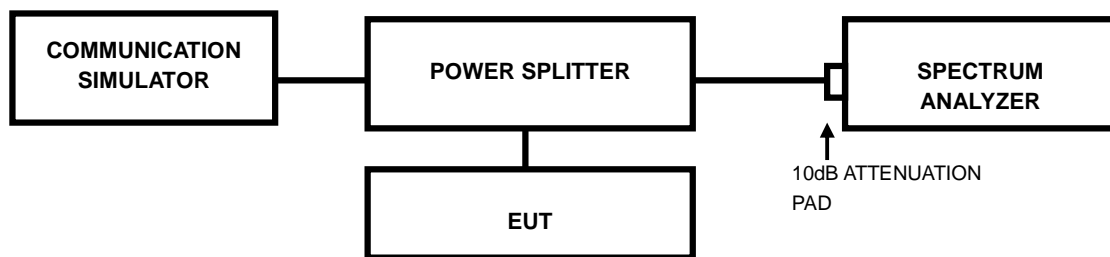

3.7.3 TEST PROCEDURES

1. Set resolution/measurement bandwidth \geq signal's occupied bandwidth;
2. Set the number of counts to a value that stabilizes the measured CCDF curve;
3. Record the maximum PAPR level associated with a probability of 0.1%.

3.7.4 TEST RESULTS

The test results was recorded in Report No.:SD72128174-0517B.



**BUREAU
VERITAS**

Test Report No.: RF181008W004-2

4 INFORMATION ON THE TESTING LABORATORIES

We, BV 7LAYERS COMMUNICATIONS TECHNOLOGY (SHENZHEN) CO. LTD., were founded in 2015 to provide our best service in EMC, Radio, Telecom and Safety consultation. Our laboratories are accredited and approved according to ISO/IEC 17025.

If you have any comments, please feel free to contact us at the following:

Shenzhen EMC/RF Lab:

Tel: +86-755-88696566

Fax: +86-755-88696577

Email: customerservice.dg@cn.bureauveritas.com

Web Site: www.adt.com.tw

The address and road map of all our labs can be found in our web site also.



Test Report No.: RF181008W004-2

5 APPENDIX A – MODIFICATIONS RECORDERS FOR ENGINEERING CHANGES TO THE EUT BY THE LAB

No any modifications are made to the EUT by the lab during the test.

---END---