

IC TEST REPORT

(RSS-130)

Product: Boron LTE
Model No.: BRN402, BRN404
IC: 20127-BRN402
Applicant: Particle Industries, Inc
Address: 126 Post St, 4th floor, San Francisco, CA 94108 USA
Manufacturer: Particle Industries, Inc
Address: 126 Post St, 4th floor, San Francisco, CA 94108 USA
Prepared by: BV 7Layers Communications Technology (Shenzhen) Co. Ltd
Lab Location: No.B102, Dazu Chuangxin Mansion, North of Beihuan Avenue, North Area, Hi-Tech Industrial Park, Nanshan District, Shenzhen, Guangdong, China
TEL: +86 755 8869 6566
FAX: +86 755 8869 6577
E-MAIL: customerservice.sw@bureauveritas.com
Report No.: ICP20120026-4
Received Date: Oct. 08, 2018
Test Date: Oct. 09, 2018 ~ Nov. 08, 2018
Issued Date: Dec. 25, 2020

This report should not be used by the client to claim product certification, approval, or endorsement by A2LA or any government agencies.

This report is governed by, and incorporates by reference, CPS Conditions of Service as posted at the date of issuance of this report at <http://www.bureauveritas.com/home/about-us/our-business/cps/about-us/terms-conditions> and is intended for your exclusive use. Any copying or replication of this report to or for any other person or entity, or use of our name or trademark, is permitted only with our prior written permission. This report sets forth our findings solely with respect to the test samples identified herein. The results set forth in this report are not indicative or representative of the quality or characteristics of the lot from which a test sample was taken or any similar or identical product unless specifically and expressly noted. Our report includes all of the tests requested by you and the results thereof based upon the information that you provided to us. Measurement uncertainty is only provided upon request for accredited tests. You have 60 days from date of issuance of this report to notify us of any material error or omission caused by our negligence or if you require measurement uncertainty; provided, however, that such notice shall be in writing and shall specifically address the issue you wish to raise. A failure to raise such issue within the prescribed time shall constitute your unqualified acceptance of the completeness of this report, the tests conducted and the correctness of the report contents.



TABLE OF CONTENTS

RELEASE CONTROL RECORD 4

1 CERTIFICATION 5

2 SUMMARY OF TEST RESULTS 6

2.1 MEASUREMENT UNCERTAINTY 6

2.2 TEST SITE AND INSTRUMENTS 7

3 GENERAL INFORMATION..... 8

3.1 GENERAL DESCRIPTION OF EUT 8

3.2 CONFIGURATION OF SYSTEM UNDER TEST 9

3.3 DESCRIPTION OF SUPPORT UNITS 10

3.4 DESCRIPTION OF TEST MODES 10

3.5 GENERAL DESCRIPTION OF APPLIED STANDARDS 11

4 TEST TYPES AND RESULTS 12

4.1 OUTPUT POWER MEASUREMENT 12

4.1.1 LIMITS OF OUTPUT POWER MEASUREMENT 12

4.1.2 TEST PROCEDURES 12

4.1.3 TEST SETUP 13

4.1.4 TEST RESULTS 14

4.2 FREQUENCY STABILITY MEASUREMENT 16

4.2.1 LIMITS OF FREQUENCY STABILITY MEASUREMENT 16

4.2.2 TEST PROCEDURE 16

4.2.3 TEST SETUP 16

4.2.4 TEST RESULTS 16

4.3 OCCUPIED BANDWIDTH MEASUREMENT 16

4.3.1 LIMITS OF OCCUPIED BANDWIDTH MEASUREMENT 17

4.3.2 TEST SETUP 17

4.3.3 TEST PROCEDURES 17

4.3.4 TEST RESULTS 17

4.4 PEAK TO AVERAGE RATIO 18

4.4.1 LIMITS OF PEAK TO AVERAGE RATIO MEASUREMENT 18

4.4.2 TEST SETUP 18

4.4.3 TEST PROCEDURES 18

4.4.4 TEST RESULTS 18

4.5 BAND EDGE MEASUREMENT 19

4.5.1 LIMITS OF BAND EDGE MEASUREMENT 19

4.5.2 TEST SETUP 19

4.5.3 TEST PROCEDURES 20

4.5.4 TEST RESULTS 20

4.6 CONDUCTED SPURIOUS EMISSIONS 21

4.6.1 LIMITS OF CONDUCTED SPURIOUS EMISSIONS MEASUREMENT 21

4.6.2 TEST PROCEDURE 21

4.6.3 TEST SETUP 21

4.6.4 TEST RESULTS 21

4.7 RADIATED EMISSION MEASUREMENT 22

4.7.1 LIMITS OF RADIATED EMISSION MEASUREMENT 22

4.7.2 TEST PROCEDURES 22

4.7.3 DEVIATION FROM TEST STANDARD 22

4.7.4 TEST SETUP 23

4.7.5 TEST RESULTS 25



5	INFORMATION ON THE TESTING LABORATORIES	39
6	APPENDIX A – MODIFICATIONS RECORDERS FOR ENGINEERING CHANGES TO THE EUT BY THE LAB.....	40



RELEASE CONTROL RECORD

ISSUE NO.	REASON FOR CHANGE	DATE ISSUED
IC181008W004-4	Original release	Nov. 16, 2018
ICP20120026-4	Based on the original report IC181008W004-4 change the product name and models, which not affect RF function. So all the test data re-use from IC181008W004-4.	Dec. 25, 2020



2 SUMMARY OF TEST RESULTS

The EUT has been tested according to the following specifications:

APPLIED STANDARD: IC RSS-130, RSS-Gen <LTE Band 12 & 13>			
STANDARD SECTION	TEST TYPE AND LIMIT	RESULT	REMARK
RSS-Gen			
4.6	Occupied Bandwidth	N/A(see note)	Meet the requirement.
STANDARD SECTION	TEST TYPE AND LIMIT	RESULT	REMARK
RSS-130			
4.3	Frequency Stability AFC Freq. Error vs. Voltage AFC Freq. Error vs. Temperature	N/A(see note)	Meet the requirement of limit.
4.4	Maximum Peak Output Power	PASS	Meet the requirement of limit.
4.4	peak-to-average power ratio	N/A(see note)	Meet the requirement of limit.
4.5	Band Edge Measurements	N/A(see note)	Meet the requirement of limit.
4.5	Conducted Spurious Emissions	N/A(see note)	Meet the requirement of limit.
4.5	Radiated Spurious Emissions	PASS	Meet the requirement of limit. Minimum passing margin is -9.26dB at 1564.000MHz.

Note: more detail please refer to the original report IC181008W004-4

* Refer to KDB 971168 D01 Power Meas License Digital Systems v03r01

2.1 MEASUREMENT UNCERTAINTY

Where relevant, the following measurement uncertainty levels have been estimated for tests performed on the EUT as specified in CISPR 16-4-2:

MEASUREMENT	FREQUENCY	UNCERTAINTY
Conducted emissions	9kHz~30MHz	2.66dB
Radiated emissions	9KHz ~ 30MHz	2.68dB
	30MHz ~ 1GMHz	3.26dB
	1GHz ~ 18GHz	4.48dB
	18GHz ~ 40GHz	4.12dB

This uncertainty represents an expanded uncertainty expressed at approximately the 95% confidence level using a coverage factor of k=2.



2.2 TEST SITE AND INSTRUMENTS

Equipment	Manufacturer	Model No.	Serial No.	Last Cal.	Next Cal.
MXE EMI Receiver	KEYSIGHT	N9038A-544	MY54450026	Mar. 16,18	Mar. 15,19
EXA Signal Analyzer	KEYSIGHT	N9010A-526	MY54510322	Mar. 16,18	Mar. 15,19
Bilog Antenna 1	ETS-LINDGREN	3143B	00161964	Nov. 26,16	Nov. 25,18
Bilog Antenna 2	ETS-LINDGREN	3143B	00161965	Nov. 26,16	Nov. 25,18
Horn Antenna 1	ETS-LINDGREN	3117	00168728	Nov. 26,16	Nov. 25,18
Horn Antenna 2	ETS-LINDGREN	3117	00168692	Nov. 26,16	Nov. 25,18
Loop antenna	Daze	ZN30900A	0708	Nov. 20,17	Nov. 19,18
Horn Antenna (18GHz-40GHz)	N/A	QWH-SL-18-40 -K-SG/QMS-00 361	15433	Dec. 16,16	Dec. 15,18
Radio Communication Analyzer	ANRITSU	MT8820C	6201465426	Mar. 02,18	Mar. 01,19
Signal Pre-Amplifier	EMSI	EMC 9135	980249	Jul. 09,18	Jul. 08,19
Signal Pre-Amplifier	EMSI	EMC 012645B	980257	Jul. 09,18	Jul. 08,19
Signal Pre-Amplifier	EMSI	EMC 184045B	980259	Jul. 09,18	Jul. 08,19
3m Semi-anechoic Chamber	ETS-LINDGREN	9m*6m*6m	Euroshieldpn- CT0001143-1216	Apr. 21,18	Apr. 20,19
Test Software	E3	V 9.160323	N/A	N/A	N/A
Test Software	ADT	ADT_Radiated _V7.6.15.9.2	N/A	N/A	N/A
10dB Attenuator	JFW/USA	50HF-010-SM A	1505	Jul. 09,18	Jul. 08,19
Power Meter	Anritsu	ML2495A	1506002	Mar. 02,18	Mar. 01,19
Power Sensor	Anritsu	MA2411B	1339352	Mar. 16,18	Mar. 15,19
Humid & Temp Programmable Tester	Juyi	ITH-120-45-CP -AR	IAA1504-001	Jul. 09,18	Jul. 08,19
MXG Analog Microwave Signal Generator	KEYSIGHT	N5183A	MY50143024	Mar. 13,18	Mar. 12,19

- NOTE:**
1. The calibration interval of the above test instruments is 12 months or 24 months and the calibrations are traceable to CEPREI/CHINA, GRGT/CHINA and NIM/CHINA.
 2. The test was performed in 3m Semi-anechoic Chamber and RF Oven Room.
 3. The horn antenna is used only for the measurement of emission frequency above 1GHz if tested.
 4. The IC test Site Registration No. is 21771-1; The CAB Identifier No. is CN0007.



3 GENERAL INFORMATION

3.1 GENERAL DESCRIPTION OF EUT

PRODUCT	Boron LTE	
MODEL NAME	BRN402, BRN404	
POWER SUPPLY	5Vdc (adapter) 3.7Vdc (battery)	
MODULATION TECHNOLOGY	LTE	QPSK, 16QAM
FREQUENCY RANGE	LTE Band 12 Channel Bandwidth: 1.4MHz	699.7MHz ~ 715.3MHz
	LTE Band 13 Channel Bandwidth: 1.4MHz	777.7MHz ~ 786.3MHz
EMISSION DESIGNATOR	LTE Band 12	QPSK: 1M14G7D 16QAM: 1M14W7D
	LTE Band 13	QPSK: 1M14G7D 16QAM: 1M21W7D
MAX. ERP/EIRP POWER	LTE Band 12 Channel Bandwidth: 1.4MHz	85mW
	LTE Band 13 Channel Bandwidth: 1.4MHz	199mW
ANTENNA TYPE	Fixed External Antenna with 1dBi	
HW VERSION	V1.00	
SW VERSION	V0.8.0	
ACCESSORY DEVICE	Refer to note as below	
DATA CABLE	N/A	

NOTE:

1. For a more detailed features description, please refer to the manufacturer’s specifications or the user’s manual.
2. For the test results, the EUT had been tested with all conditions. But only the worst case was shown in test report.
3. The differences of BRN404 and BRN402 are as follow: BRN402 uses eSIM of Kore. BRN404 uses eSIM of Twilio.



3.2 CONFIGURATION OF SYSTEM UNDER TEST

FOR RADIATION EMISSION TEST & E.R.P. TEST

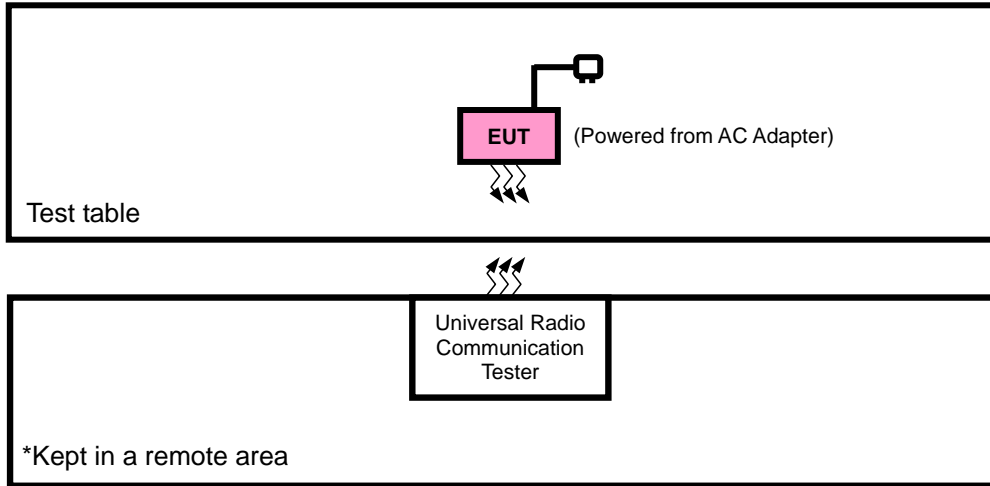

FOR CONDUCTED & E.R.P./E.I.R.P TEST

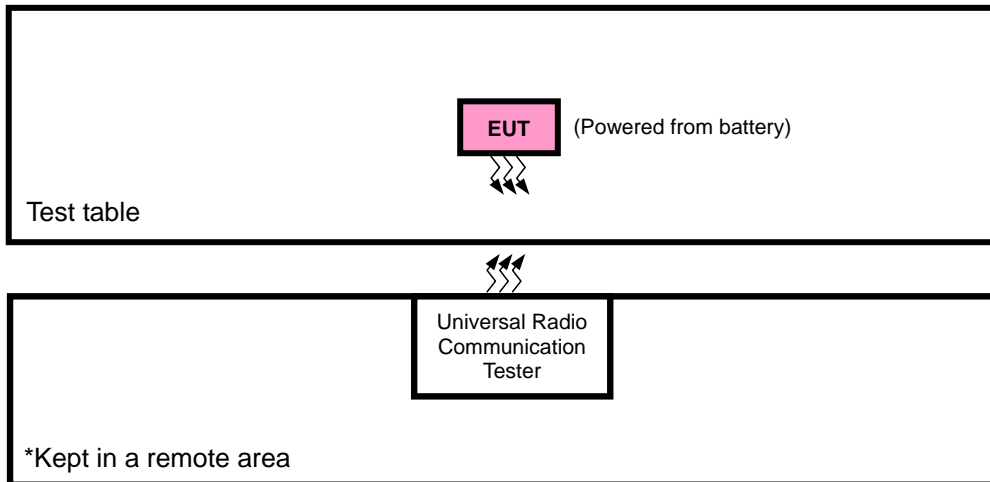



3.3 DESCRIPTION OF SUPPORT UNITS

The EUT has been tested as an independent unit together with other necessary accessories or support units. The following support units or accessories were used to form a representative test configuration during the tests.

NO.	PRODUCT	BRAND	MODEL NO.	SERIAL NO.	FCC ID
1	DC source	LONG WEI	PS-6403D	010934269	N/A
2	PC	HP	A6608CN	3CR83825X3	N/A
3	USB	N/A	N/A	N/A	N/A
4	Battery	N/A	N/A	N/A	N/A
5	Adapter	N/A	N/A	N/A	N/A

NO.	SIGNAL CABLE DESCRIPTION OF THE ABOVE SUPPORT UNITS
1	DC Line: Unshielded, Detachable 1.0m
2	AC Line: Unshielded, Detachable 1.5m
3	N/A
4	N/A
5	N/A

NOTE:

1. All power cords of the above support units are non shielded (1.8m).

3.4 DESCRIPTION OF TEST MODES

Pre-Scan has been conducted to determine the worst-case mode from all possible combinations between available modulations, data rates, XYZ axis and antenna ports. The worst case was found when positioned on Y-plane for ERP and X-axis for radiated emission. Following channel(s) was (were) selected for the final test as listed below:

EUT CONFIGURE MODE	DESCRIPTION
A	EUT + Adapter + USB Cable with LTE link
B	EUT + Battery with LTE link



LTE BAND 12

EUT CONFIGURE MODE	TEST ITEM	AVAILABLE CHANNEL	TESTED CHANNEL	CHANNEL BANDWIDTH	MODULATION	MODE
B	ERP	23017 to 23173	23017, 23095 , 23173	1.4MHz	QPSK,16QAM	1 RB / 0 RB Offset
A	RADIATED EMISSION	23017 to 23173	23017, 23095 , 23173	1.4MHz	QPSK	1 RB / 0 RB Offset

Note: This device was tested under all bandwidths, RB configurations and modulations. The worst case was found in QPSK modulation.

LTE BAND 13

EUT CONFIGURE MODE	TEST ITEM	AVAILABLE CHANNEL	TESTED CHANNEL	CHANNEL BANDWIDTH	MODULATION	MODE
B	ERP	23187 to 23273	23187, 23230, 23273	1.4MHz	QPSK, 16QAM	1 RB / 0 RB Offset
A	RADIATED EMISSION	23187 to 23273	23187, 23230, 23273	1.4MHz	QPSK	1 RB / 0 RB Offset

Note: This device was tested under all bandwidths, RB configurations and modulations. The worst case was found in QPSK modulation.

TEST CONDITION:

TEST ITEM	ENVIRONMENTAL CONDITIONS	INPUT POWER	TESTED BY
EIRP(ERP)	24deg. C, 60%RH	3.7Vdc from Battery	Star Le
RADIATED EMISSION	26deg. C, 56%RH	DC 5V from adaptor	Star Le

3.5 GENERAL DESCRIPTION OF APPLIED STANDARDS

The EUT is a RF product. According to the specifications of the manufacturer, it must comply with the requirements of the following standards:

Canada RSS-130, Issue 1, October 2013

Canada RSS-Gen, Issue 5, April 2018

ANSI C63.26 - 2015

NOTE: All test items have been performed and recorded as per the above standards.



4 TEST TYPES AND RESULTS

4.1 OUTPUT POWER MEASUREMENT

4.1.1 LIMITS OF OUTPUT POWER MEASUREMENT

Fixed, mobile, and portable (hand-held) stations are limited to 5 watts e.r.p.

4.1.2 TEST PROCEDURES

EIRP / ERP MEASUREMENT:

- a. The EUT was set up for the maximum power with LTE link data modulation. The power was measured with R&S Spectrum Analyzer. All measurements were done at 3 channels (low, middle and high operational frequency range). RBW and VBW is 10MHz for LTE.
- b. E.I.R.P power measurement. In the semi-anechoic chamber, EUT placed on the 0.8m height of Turn Table, rotated the table around 360 degrees to search the maximum radiation power and receiver antenna shall be rotated vertical and horizontal polarization and moved height from 1m to 4m to find the maximum polar radiated power. The “Read Value” is the spectrum reading the maximum power value.
- c. The substitution horn antenna is substituted for EUT at the same position and signals generator export the CW signal to the substitution antenna via a TX cable. Rotated the Turn Table and moved receiving antenna to find the maximum radiation power. Adjust output power level of S.G to get a Value of spectrum reading equal to “Read Value” of step a. Record the power level of S.G
- d. $EIRP = \text{Output power level of S.G} - \text{TX cable loss} + \text{Antenna gain of substitution horn}$
- e. $E.R.P = E.I.R.P - 2.15 \text{ dB}$

CONDUCTED POWER MEASUREMENT:

- a. The EUT was set up for the maximum power with LTE link data modulation and link up with simulator.
- b. Set the EUT to transmit under low, middle and high channel and record the power level shown on simulator.



4.1.3 TEST SETUP

EIRP / ERP MEASUREMENT:

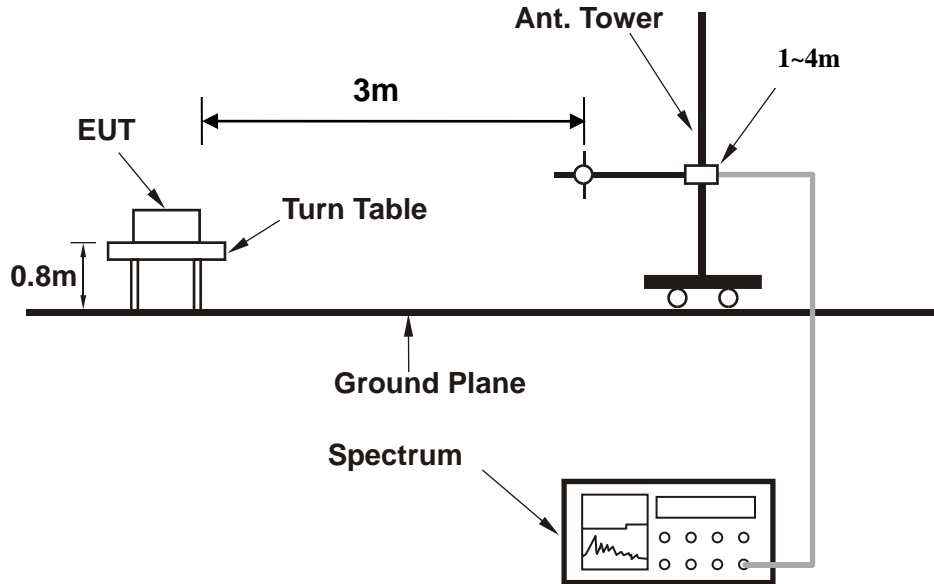

For the actual test configuration, please refer to the attached file (Test Setup Photo).

CONDUCTED POWER MEASUREMENT:

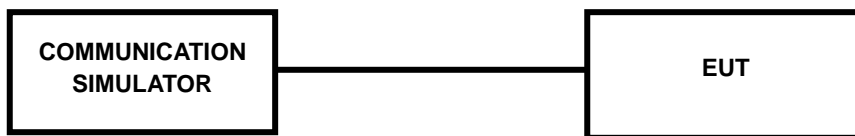

For the actual test configuration, please refer to the attached file (Test Setup Photo).



4.1.4 TEST RESULTS

AVERAGE CONDUCTED OUTPUT POWER (dBm)

The test results were recorded in Reports No.:SD72128174-0517A & SD72132148-1017A.

ERP

Loss + Antenna Factor + Cable Loss

LTE BAND 12

CHANNEL BANDWIDTH: 1.4MHz QPSK

Channel	Frequency (MHz)	SPA LVL (dBm)	Correction Factor(dB)	ERP(dBm)	ERP(mW)	Polarization (H/V)	LIMIT (W)
23017	699.7	-12.75	32.77	17.87	61.24	H	5
23095	707.5	-11.81	33.23	19.27	84.53	H	5
23173	715.3	-12.37	33.14	18.62	72.74	H	5
23017	699.7	-23.83	32.42	6.44	4.40	V	5
23095	707.5	-24.95	32.60	5.50	3.55	V	5
23173	715.3	-25.06	32.19	4.98	3.14	V	5

CHANNEL BANDWIDTH: 1.4MHz 16QAM

Channel	Frequency (MHz)	SPA LVL (dBm)	Correction Factor(dB)	ERP(dBm)	ERP(mW)	Polarization (H/V)	LIMIT (W)
23017	699.7	-13.58	32.77	17.04	50.58	H	5
23095	707.5	-12.83	33.23	18.25	66.83	H	5
23173	715.3	-13.47	33.14	17.52	56.47	H	5
23017	699.7	-24.66	32.42	5.61	3.64	V	5
23095	707.5	-25.97	32.60	4.48	2.81	V	5
23173	715.3	-26.16	32.19	3.88	2.44	V	5

REMARKS: 1. ERP Output Power (dBm) = SPA LVL (dBm) + Correction Factor (dB) -2.15(dB).

2. Correction factor (dB) = Free Space Loss + Antenna Factor + Cable Loss



LTE BAND 13

CHANNEL BANDWIDTH: 1.4MHz QPSK

Channel	Frequency (MHz)	SPA LVL (dBm)	Correction Factor(dB)	ERP(dBm)	ERP(mW)	Polarization (H/V)	LIMIT (W)
23187	777.7	-14.56	32.60	15.89	38.82	H	5
23230	782.0	-15.14	32.75	15.46	35.16	H	5
23273	786.3	-15.76	33.08	15.17	32.89	H	5
23187	777.7	-24.05	31.54	5.34	3.42	V	5
23230	782.0	-24.39	31.70	5.16	3.28	V	5
23273	786.3	-25.12	31.97	4.70	2.95	V	5

CHANNEL BANDWIDTH: 1.4MHz 16QAM

Channel	Frequency (MHz)	SPA LVL (dBm)	Correction Factor(dB)	ERP(dBm)	ERP(mW)	Polarization (H/V)	LIMIT (W)
23187	777.7	-8.08	32.60	22.37	172.58	H	5
23230	782.0	-7.62	32.75	22.98	198.61	H	5
23273	786.3	-7.98	33.08	22.95	197.24	H	5
23187	777.7	-18.55	31.54	10.84	12.13	V	5
23230	782.0	-18.98	31.70	10.57	11.40	V	5
23273	786.3	-19.02	31.97	10.80	12.02	V	5

NOTE: ERP (dBm) = LVL (dBm) + Correction Factor (dB)-2.15dB.



4.2 FREQUENCY STABILITY MEASUREMENT

4.2.1 LIMITS OF FREQUENCY STABILITY MEASUREMENT

The frequency stability shall be sufficient to ensure that the fundamental emissions stay within the authorized bands of operation.

4.2.2 TEST PROCEDURE

- a. Device is placed at the oven room. The oven room could control the temperatures and humidity. Power warm up is at least 15 min and power applied should perform before recording frequency error.
- b. EUT is connected the external power supply to control the DC input power. The test voltage range is from minimum to maximum working voltage. Each step shall be record the frequency error rate.
- c. The temperature range step is 10 degrees in this test items. All temperature levels shall be hold the $\pm 0.5^{\circ}\text{C}$ during the measurement testing. The each temperature step shall be at least 0.5 hours, consider the EUT could be test under the stability condition.

NOTE: The frequency error was recorded frequency error from the communication simulator.

4.2.3 TEST SETUP

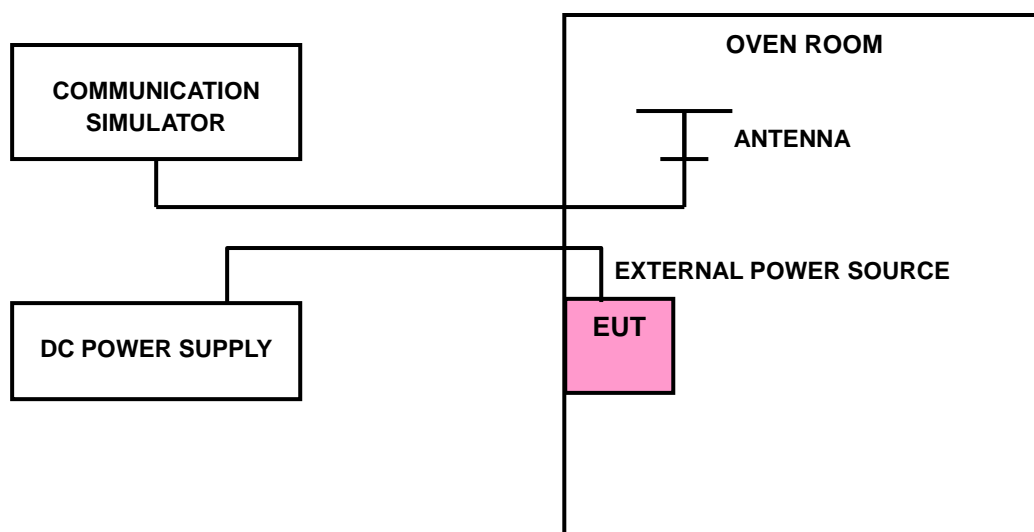

4.2.4 TEST RESULTS

The test results were recorded in Reports No.:SD72128174-0517A & SD72132148-1017A.



4.3 OCCUPIED BANDWIDTH MEASUREMENT

4.3.1 LIMITS OF OCCUPIED BANDWIDTH MEASUREMENT

The width of a frequency band such that, below the lower and above the upper frequency limits, the mean powers emitted are each equal to a specified percentage 0.5 %of the total mean power of a given emission.

4.3.2 TEST SETUP

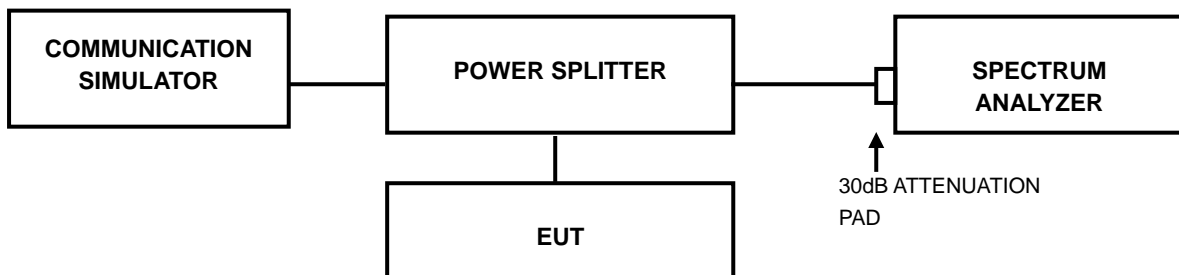

4.3.3 TEST PROCEDURES

- a. The conducted occupied bandwidth used the power splitter via EUT RF power connector between simulation base station and spectrum analyzer.
- b. Use OBW measurement function of Spectrum analyzer to measure 99 % occupied bandwidth.

4.3.4 TEST RESULTS

The test results were recorded in Reports No.:SD72128174-0517A & SD72132148-1017A.



4.4 PEAK TO AVERAGE RATIO

4.4.1 LIMITS OF PEAK TO AVERAGE RATIO MEASUREMENT

In measuring transmissions in this band using an average power technique, the peak to-average ratio (PAR) of the transmission may not exceed 13 dB

4.4.2 TEST SETUP

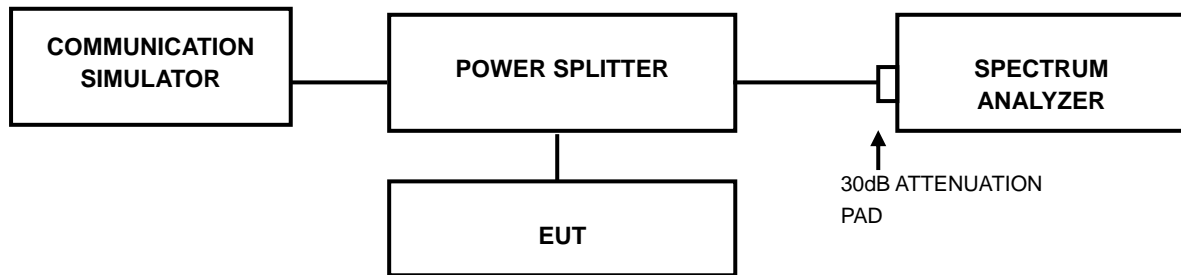

4.4.3 TEST PROCEDURES

1. Set resolution/measurement bandwidth \geq signal's occupied bandwidth;
2. Set the number of counts to a value that stabilizes the measured CCDF curve;
3. Record the maximum PAPR level associated with a probability of 0.1%.

4.4.4 TEST RESULTS

The test results were recorded in Reports No.:SD72128174-0517A & SD72132148-1017A.



4.5 BAND EDGE MEASUREMENT

4.5.1 LIMITS OF BAND EDGE MEASUREMENT

The power of any emission outside a licensee's frequency band(s) of operation shall be attenuated below the transmitter power (P) within the licensed band(s) of operation, measured in watts, by at least $43 + 10 \log (P)$ dB. Compliance with this provision is based on the use of measurement instrumentation employing a resolution bandwidth of 100 kilohertz or greater.

However, in the 100 kilohertz bands immediately outside and adjacent to a licensee's frequency block, a resolution bandwidth of at least 30 kHz may be employed.

4.5.2 TEST SETUP

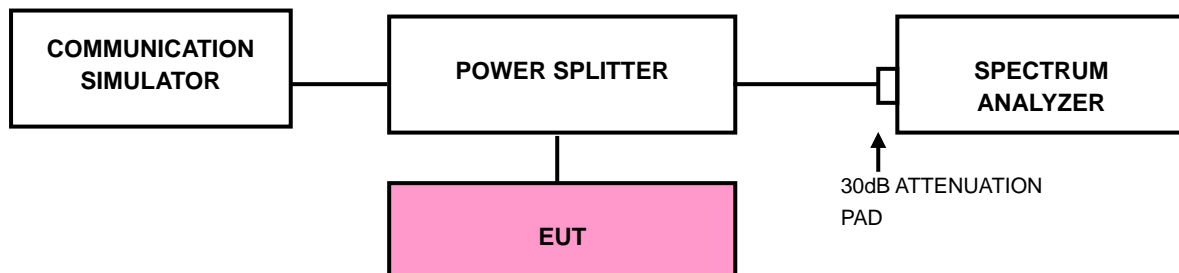



4.5.3 TEST PROCEDURES

- a. The EUT was set up for the maximum peak power with LTE link data modulation. The power was measured with R&S Spectrum Analyzer. All measurements were done at 2 channels (low and high operational frequency range.).
- b. The band edge measurement used the power splitter via EUT RF power connector between simulation base station and spectrum analyzer.
- c. The center frequency of spectrum is the band edge frequency and span is 1~5 MHz. RBW of the spectrum is 20kHz and VBW of the spectrum is 100 kHz. (LTE bandwidth 1.4MHz)
- d. The center frequency of spectrum is the band edge frequency and span is 1~5 MHz. RBW of the spectrum is 30kHz and VBW of the spectrum is 100kHz. (LTE bandwidth 3MHz)
- e. The center frequency of spectrum is the band edge frequency and span is 1~5 MHz. RBW of the spectrum is 50kHz and VBW of the spectrum is 200kHz. (LTE bandwidth 5MHz)
- f. The center frequency of spectrum is the band edge frequency and span is 1~5 MHz. RBW of the spectrum is 100kHz and VBW of the spectrum is 300kHz. (LTE bandwidth 10MHz)
- g. The center frequency of spectrum is the band edge frequency and span is 1~5 MHz. RBW of the spectrum is 200kHz and VBW of the spectrum is 1MHz. (LTE bandwidth 15MHz)
- h. The center frequency of spectrum is the band edge frequency and span is 1~5 MHz. RBW of the spectrum is 200kHz and VBW of the spectrum is 1MHz. (LTE bandwidth 20MHz)
- i. Record the max trace plot into the test report.

4.5.4 TEST RESULTS

The test results were recorded in Reports No.:SD72128174-0517A & SD72132148-1017A.



4.6 CONDUCTED SPURIOUS EMISSIONS

4.6.1 LIMITS OF CONDUCTED SPURIOUS EMISSIONS MEASUREMENT

The power of any emission outside a licensee's frequency block shall be attenuated below the transmitter power (P) by at least $43 + 10 \log_{10}(P)$ dB. The limit of emission equal to -13dBm

4.6.2 TEST PROCEDURE

- a. The EUT makes a phone call to the communication simulator. All measurements were done at middle operational frequency range.
- b. Measuring frequency range is from 30 MHz to 8GHz for LTE Band 12&13. 10dB attenuation pad is connected with spectrum. RBW=1MHz and VBW=3MHz are used for conducted emission measurement.

4.6.3 TEST SETUP

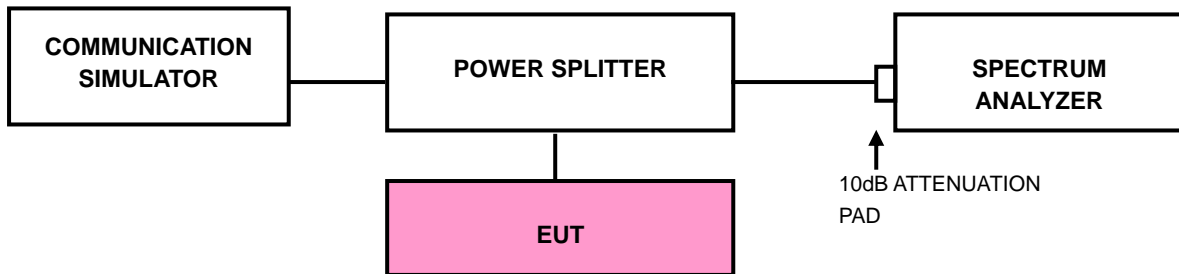

4.6.4 TEST RESULTS

The test results were recorded in Reports No.:SD72128174-0517A & SD72132148-1017A.



4.7 RADIATED EMISSION MEASUREMENT

4.7.1 LIMITS OF RADIATED EMISSION MEASUREMENT

The power of any emission outside a licensee's frequency block shall be attenuated below the transmitter power (P) by at least $43 + 10 \log_{10}(P)$ dB. The limit of emission equal to -13dBm

4.7.2 TEST PROCEDURES

- a. Substitution method is used for E.I.R.P measurement. In the semi-anechoic chamber, EUT placed on the 0.8m/1.5m height of Turn Table, rotated the table around 360 degrees to search the maximum radiation power and receiver antenna shall be rotated vertical and horizontal polarization and moved height from 1m to 4m to find the maximum polar radiated power. The "Read Value" is the spectrum reading the maximum power value.
- b. The substitution horn antenna is substituted for EUT at the same position and signals generator export the CW signal to the substitution antenna via a TX cable. Rotated the Turn Table and moved receiving antenna to find the maximum radiation power. Adjust output power level of S.G to get a Value of spectrum reading equal to "Read Value" of step a. Record the power level of S.G
- c. $\text{EIRP} = \text{Output power level of S.G} - \text{TX cable loss} + \text{Antenna gain of substitution horn.}$
- d. E.R.P power can be calculated form E.I.R.P power by subtracting the gain of dipole,
 $\text{E.R.P power} = \text{E.I.P.R power} - 2.15\text{dBi.}$

NOTE: The resolution bandwidth of spectrum analyzer is 1 MHz and the video bandwidth is 3 MHz.

4.7.3 DEVIATION FROM TEST STANDARD

No deviation



4.7.4 TEST SETUP

< Frequency Range below 30MHz >

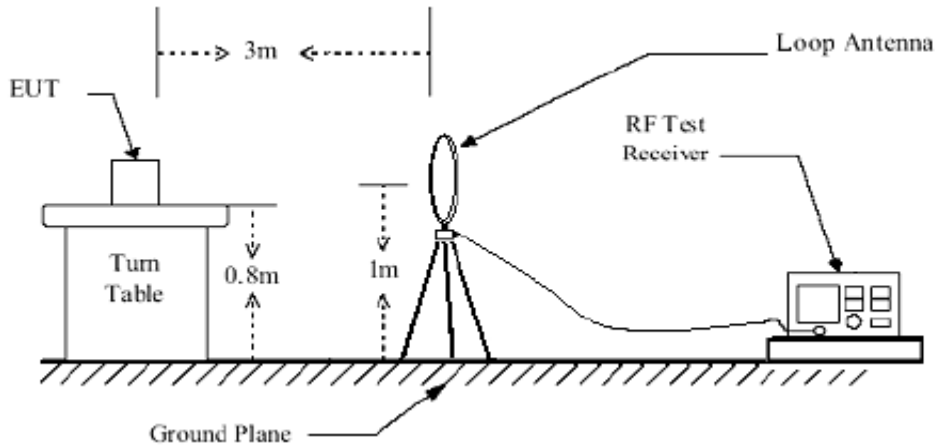

< Frequency Range 30MHz~1GHz >

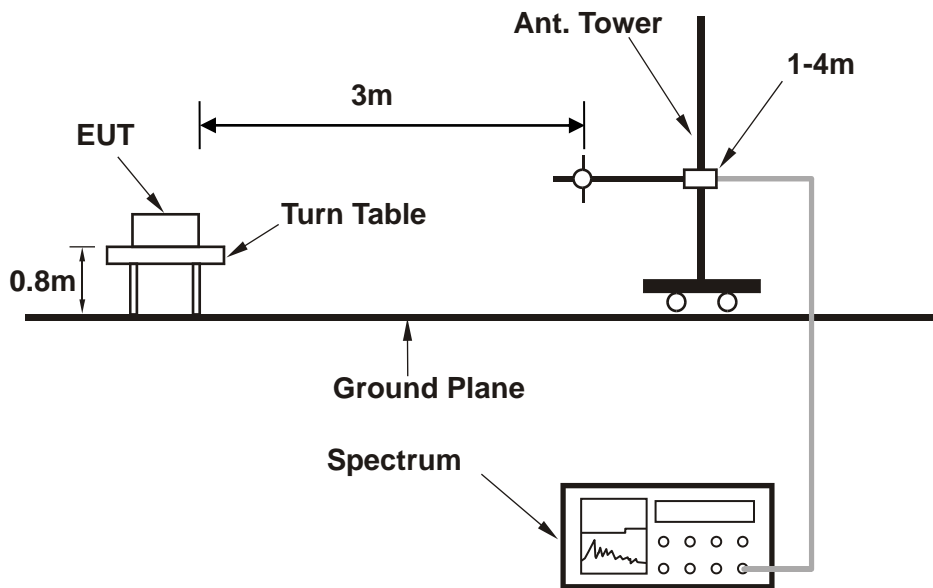



< Frequency Range above 1GHz >

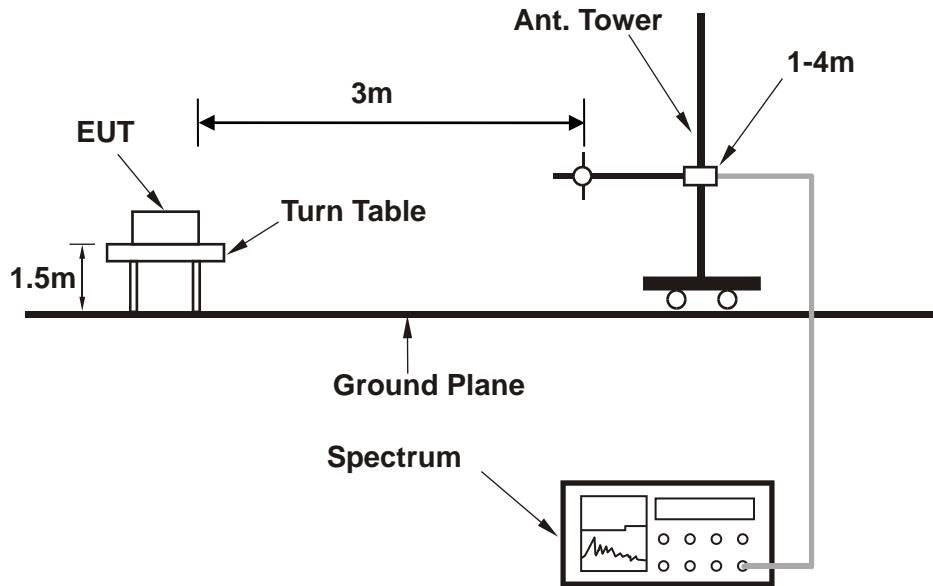

For the actual test configuration, please refer to the attached file (Test Setup Photo).



4.7.5 TEST RESULTS

BELOW 1GHz WORST-CASE DATA

9 KHz – 30 MHz data: the amplitude of spurious emissions attenuated more than 20 dB below the permissible value is not required in the report.

30 MHz – 1GHz data:

LTE Band 13:

MODE	TX channel 23230	FREQUENCY RANGE	Below 1000MHz
ENVIRONMENTAL CONDITIONS	23deg. C, 70%RH	INPUT POWER	DC 5V from adapter
TESTED BY	Star Le		
ANTENNA POLARITY & TEST DISTANCE: HORIZONTAL AT 3 M			

	Freq	Level	Read Level	Limit Line	Over Limit	Factor	Remark	Pol/Phase
	MHz	dBm/m	dBm	dBm/m	dB	dB/m		
1	50.230	-53.37	-56.25	-13.00	-40.37	2.88	Peak	Horizontal
2 PP	90.150	-49.25	-40.17	-13.00	-36.25	-9.08	Peak	Horizontal
3	105.340	-53.84	-41.57	-13.00	-40.84	-12.27	Peak	Horizontal
4	175.210	-59.35	-41.42	-13.00	-46.35	-17.93	Peak	Horizontal
5	189.640	-56.07	-38.56	-13.00	-43.07	-17.51	Peak	Horizontal
6	231.550	-56.11	-39.48	-13.00	-43.11	-16.63	Peak	Horizontal

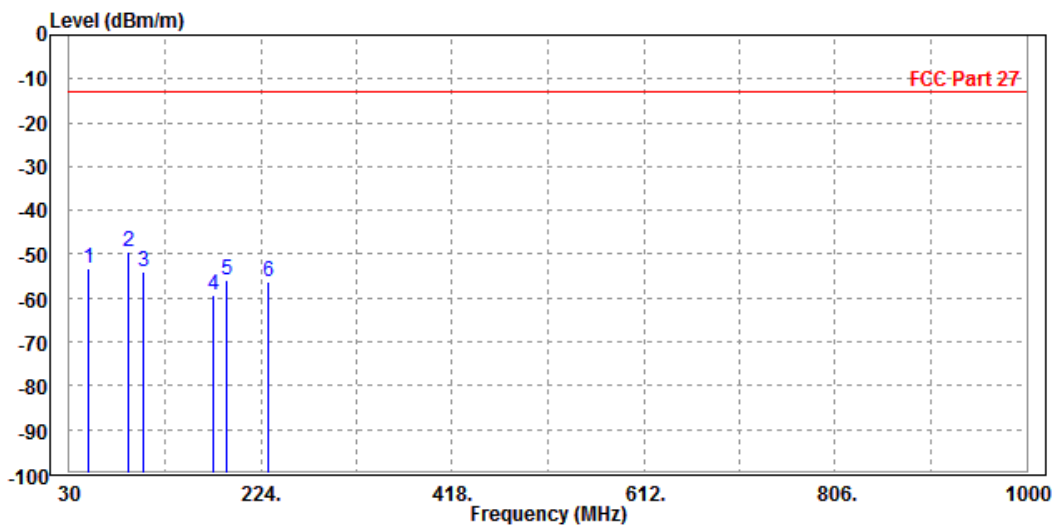



MODE	TX channel 23230	FREQUENCY RANGE	Below 1000MHz
ENVIRONMENTAL CONDITIONS	23deg. C, 70%RH	INPUT POWER	DC 5V from adapter
TESTED BY	Star Le		
ANTENNA POLARITY & TEST DISTANCE: VERTICAL AT 3 M			

	Freq	Level	Read Level	Limit Line	Over Limit	Factor	Remark	Pol/Phase
	MHz	dBm/m	dBm	dBm/m	dB	dB/m		
1	45.260	-41.82	-38.56	-13.00	-28.82	-3.26	Peak	Vertical
2 PP	78.620	-29.85	-18.87	-13.00	-16.85	-10.98	Peak	Vertical
3	102.850	-51.04	-39.99	-13.00	-38.04	-11.05	Peak	Vertical
4	142.180	-61.60	-45.65	-13.00	-48.60	-15.95	Peak	Vertical
5	172.590	-56.49	-42.54	-13.00	-43.49	-13.95	Peak	Vertical
6	201.350	-57.35	-46.69	-13.00	-44.35	-10.66	Peak	Vertical

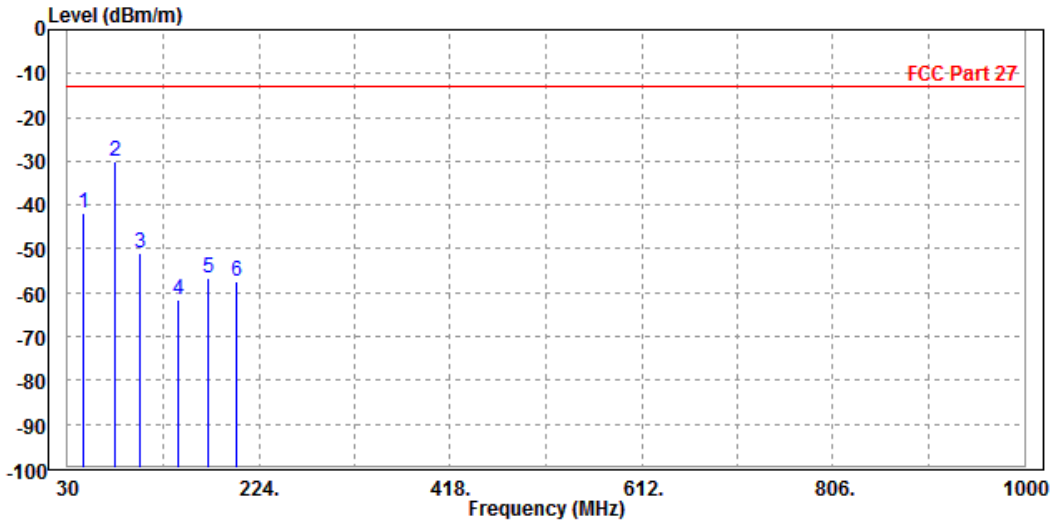



ABOVE 1GHz

Note: For higher frequency, the emission is too low to be detected.

LTE BAND 12

CHANNEL BANDWIDTH: 1.4MHz / QPSK

CH23017

MODE	TX channel 23017	FREQUENCY RANGE	Above 1000MHz
ENVIRONMENTAL CONDITIONS	23deg. C, 70%RH	INPUT POWER	DC 5V from adapter
TESTED BY	Star Le		
ANTENNA POLARITY & TEST DISTANCE: HORIZONTAL AT 3 M			

	Freq	Level	Read Level	Limit Line	Over Limit	Factor	Remark	Pol/Phase
	MHz	dBm/m	dBm	dBm/m	dB	dB/m		
1	PP 1390.000	-42.69	-35.81	-13.00	-29.69	-6.88	Peak	Horizontal
2	2100.000	-52.14	-50.19	-13.00	-39.14	-1.95	Peak	Horizontal

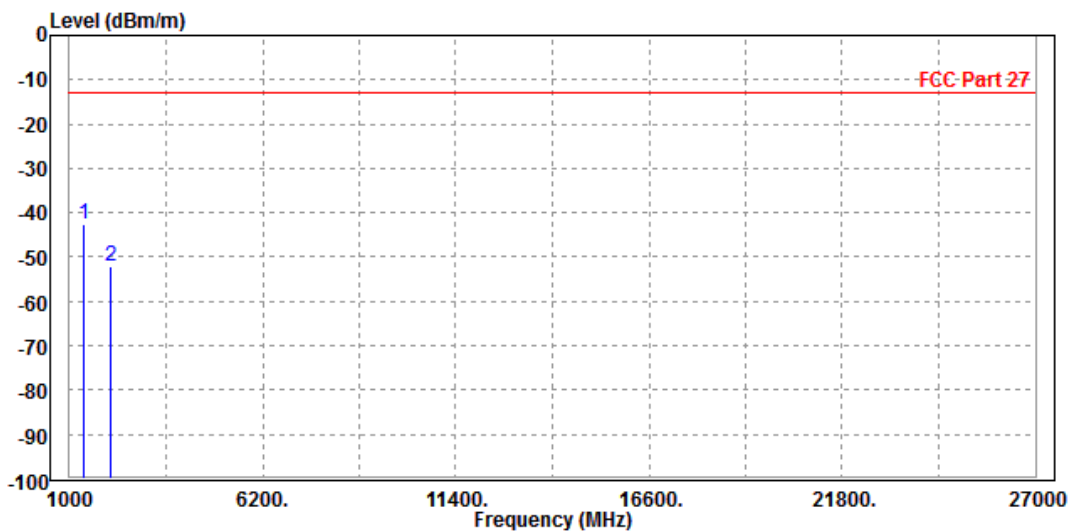



MODE	TX channel 23017	FREQUENCY RANGE	Above 1000MHz
ENVIRONMENTAL CONDITIONS	23deg. C, 70%RH	INPUT POWER	DC 5V from adapter
TESTED BY	Star Le		
ANTENNA POLARITY & TEST DISTANCE: VERTICAL AT 3 M			

	Freq	Level	Read Level	Limit Line	Over Limit	Factor	Remark	Pol/Phase
	MHz	dBm/m	dBm	dBm/m	dB	dB/m		
1	PP 1390.000	-44.49	-38.89	-13.00	-31.49	-5.60	Peak	Vertical
2	2100.000	-53.03	-52.78	-13.00	-40.03	-0.25	Peak	Vertical

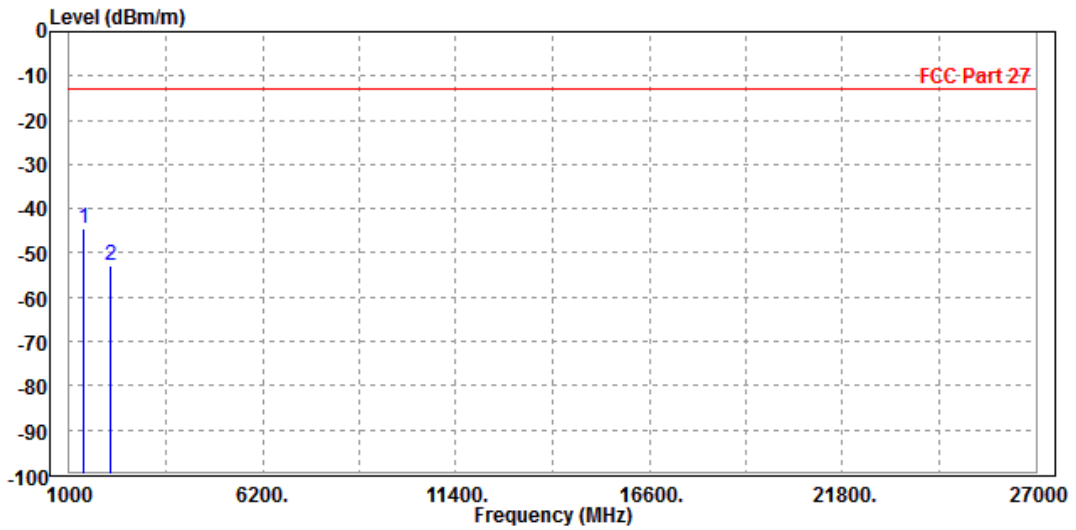



CH23095

MODE	TX channel 23095	FREQUENCY RANGE	Above 1000MHz
ENVIRONMENTAL CONDITIONS	23deg. C, 70%RH	INPUT POWER	DC 5V from adapter
TESTED BY	Star Le		
ANTENNA POLARITY & TEST DISTANCE: HORIZONTAL AT 3 M			

	Freq	Level	Read Level	Limit Line	Over Limit	Factor	Remark	Pol/Phase
	MHz	dBm/m	dBm	dBm/m	dB	dB/m		
1	PP 1416.000	-46.96	-40.24	-13.00	-33.96	-6.72	Peak	Horizontal
2	2122.500	-53.64	-51.71	-13.00	-40.64	-1.93	Peak	Horizontal

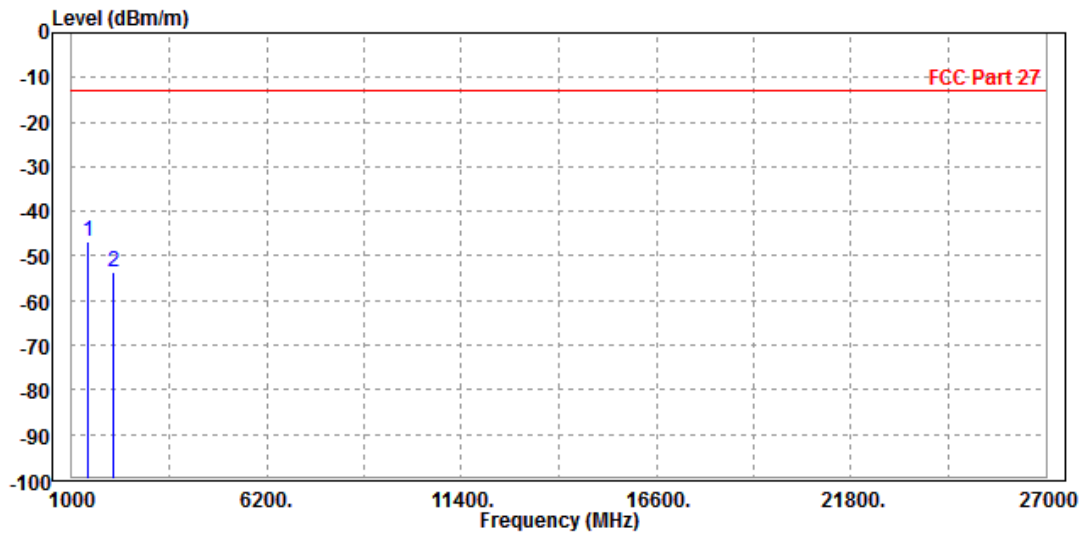



MODE	TX channel 23095	FREQUENCY RANGE	Above 1000MHz
ENVIRONMENTAL CONDITIONS	23deg. C, 70%RH	INPUT POWER	DC 5V from adapter
TESTED BY	Star Le		
ANTENNA POLARITY & TEST DISTANCE: VERTICAL AT 3 M			

	Freq	Level	Read Level	Limit Line	Over Limit	Factor	Remark	Pol/Phase
	MHz	dBm/m	dBm	dBm/m	dB	dB/m		
1	PP 1416.000	-47.92	-42.48	-13.00	-34.92	-5.44	Peak	Vertical
2	2122.500	-52.75	-52.51	-13.00	-39.75	-0.24	Peak	Vertical

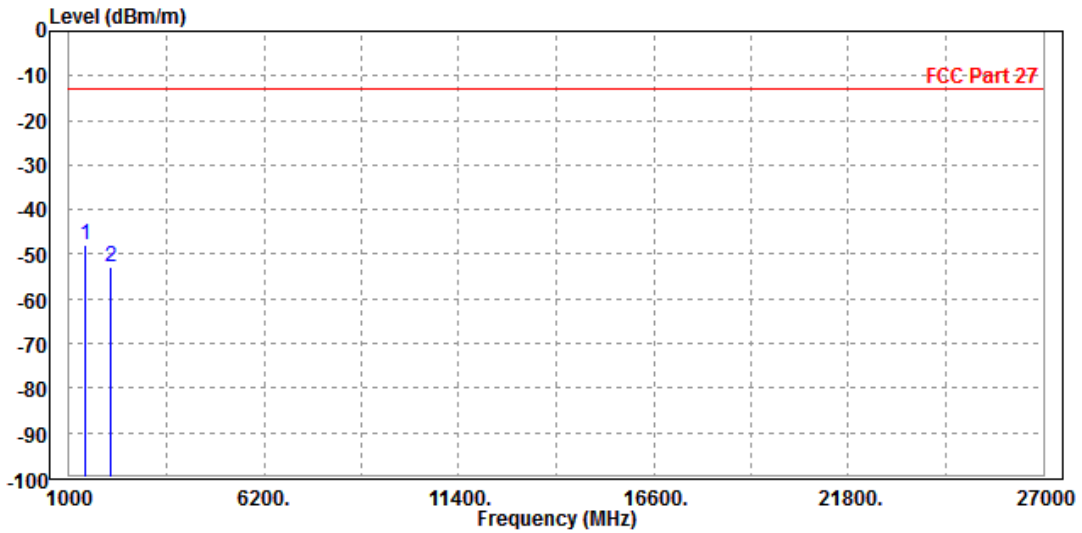



CH23173

MODE	TX channel 23173	FREQUENCY RANGE	Above 1000MHz
ENVIRONMENTAL CONDITIONS	23deg. C, 70%RH	INPUT POWER	DC 5V from adapter
TESTED BY	Star Le		
ANTENNA POLARITY & TEST DISTANCE: HORIZONTAL AT 3 M			

	Freq	Level	Read Level	Limit	Over Limit	Factor	Remark	Pol/Phase
	MHz	dBm/m	dBm	dBm/m	dB	dB/m		
1	PP 1416.000	-43.39	-36.67	-13.00	-30.39	-6.72	Peak	Horizontal
2	2133.000	-55.82	-53.89	-13.00	-42.82	-1.93	Peak	Horizontal

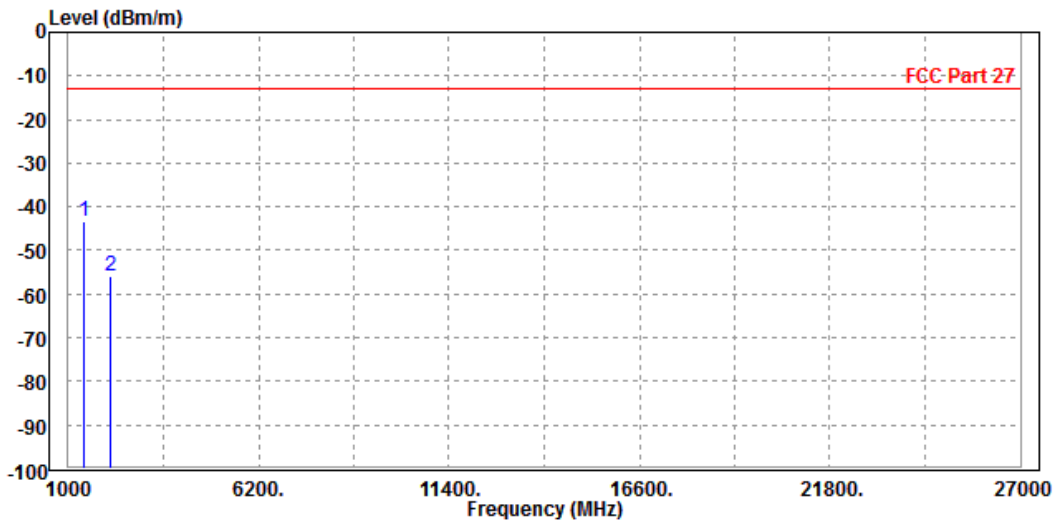



MODE	TX channel 23173	FREQUENCY RANGE	Above 1000MHz
ENVIRONMENTAL CONDITIONS	23deg. C, 70%RH	INPUT POWER	DC 5V from adapter
TESTED BY	Star Le		
ANTENNA POLARITY & TEST DISTANCE: VERTICAL AT 3 M			

	Freq	Level	Read Level	Limit Line	Over Limit	Factor	Remark	Pol/Phase
	MHz	dBm/m	dBm	dBm/m	dB	dB/m		
1	PP 1416.000	-44.65	-39.21	-13.00	-31.65	-5.44	Peak	Vertical
2	2133.000	-54.10	-53.86	-13.00	-41.10	-0.24	Peak	Vertical

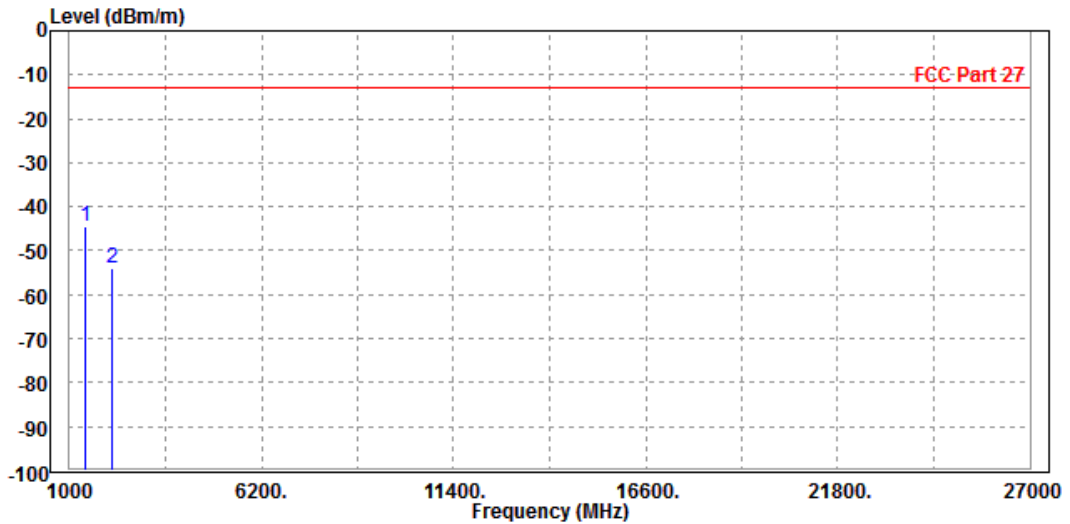



LTE BAND 13

CHANNEL BANDWIDTH: 1.4MHz / QPSK

CH 23187

MODE	TX channel 23187	FREQUENCY RANGE	Above 1000MHz
ENVIRONMENTAL CONDITIONS	23deg. C, 70%RH	INPUT POWER	DC 5V from adapter
TESTED BY	Star Le		
ANTENNA POLARITY & TEST DISTANCE: HORIZONTAL AT 3 M			

		Read	Limit	Over				
	Freq	Level	Level	Line	Limit	Factor	Remark	Pol/Phase
	MHz	dBm/m	dBm	dBm/m	dB	dB/m		
1	PP 1564.000	-49.26	-43.59	-40.00	-9.26	-5.67	Peak	Horizontal
2	2350.000	-45.20	-43.45	-13.00	-32.20	-1.75	Peak	Horizontal

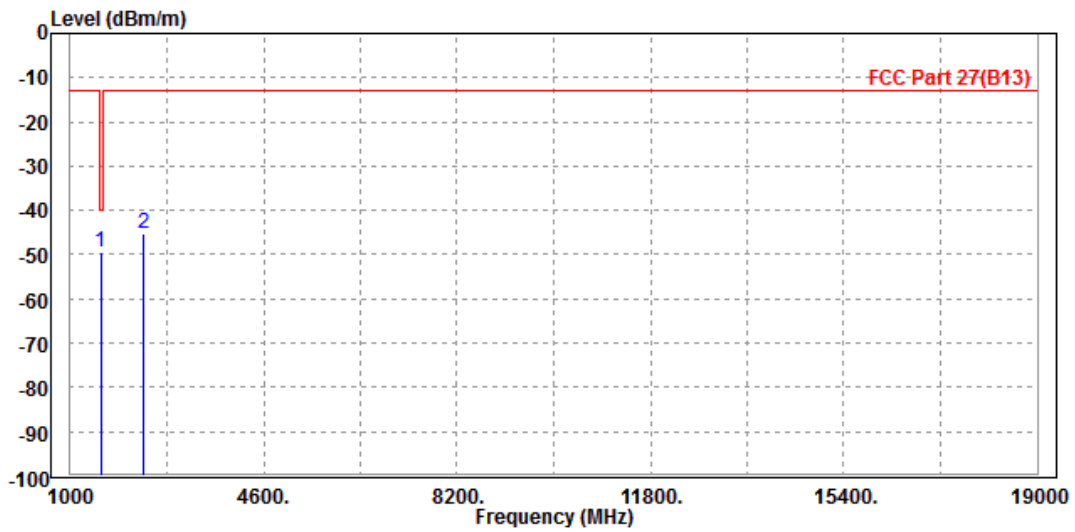



MODE	TX channel 23187	FREQUENCY RANGE	Above 1000MHz
ENVIRONMENTAL CONDITIONS	23deg. C, 70%RH	INPUT POWER	DC 5V from adapter
TESTED BY	Star Le		
ANTENNA POLARITY & TEST DISTANCE: VERTICAL AT 3 M			

	Freq	Level	Read Level	Limit Line	Over Limit	Factor	Remark	Pol/Phase
	MHz	dBm/m	dBm	dBm/m	dB	dB/m		
1 PP	1564.000	-53.05	-48.72	-40.00	-13.05	-4.33	Peak	Vertical
2	2338.000	-42.41	-42.21	-13.00	-29.41	-0.20	Peak	Vertical

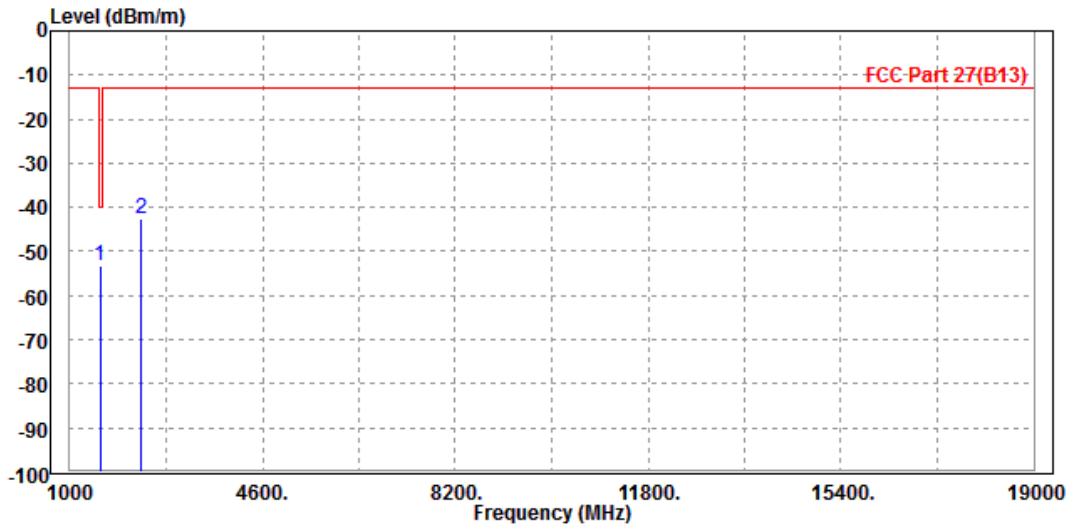



CH 23230

MODE	TX channel 23230	FREQUENCY RANGE	Above 1000MHz
ENVIRONMENTAL CONDITIONS	23deg. C, 70%RH	INPUT POWER	DC 5V from adapter
TESTED BY	Star Le		
ANTENNA POLARITY & TEST DISTANCE: HORIZONTAL AT 3 M			

	Freq	Level	Read Level	Limit Line	Over Limit	Factor	Remark	Pol/Phase
	MHz	dBm/m	dBm	dBm/m	dB	dB/m		
1	PP 1564.000	-52.12	-46.45	-40.00	-12.12	-5.67	Peak	Horizontal
2	2350.000	-45.00	-43.25	-13.00	-32.00	-1.75	Peak	Horizontal

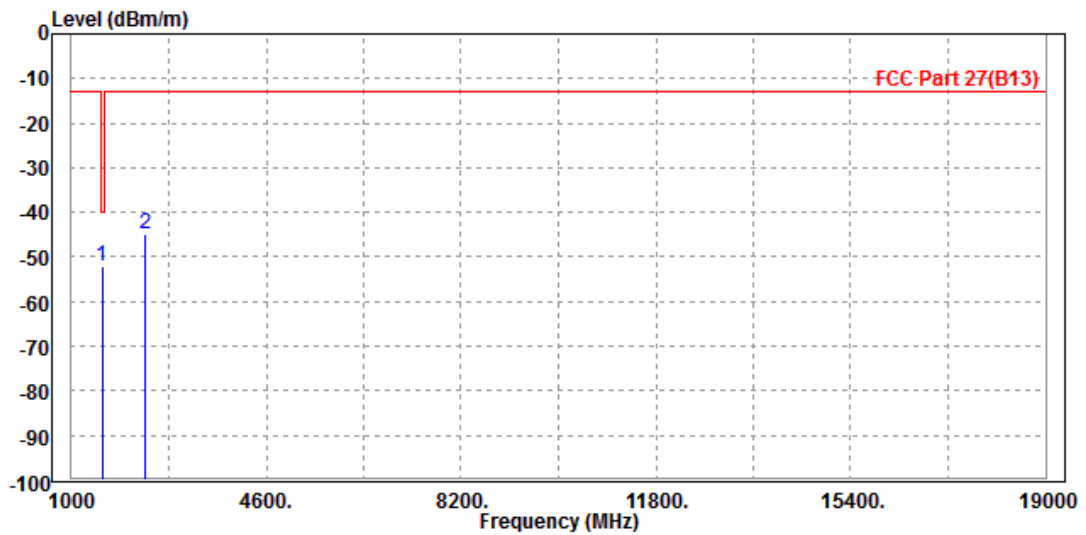



MODE	TX channel 23230	FREQUENCY RANGE	Above 1000MHz
ENVIRONMENTAL CONDITIONS	23deg. C, 70%RH	INPUT POWER	DC 5V from adapter
TESTED BY	Star Le		
ANTENNA POLARITY & TEST DISTANCE: VERTICAL AT 3 M			

	Freq	Level	Read Level	Limit Line	Over Limit	Factor	Remark	Pol/Phase
	MHz	dBm/m	dBm	dBm/m	dB	dB/m		
1 PP	1564.000	-51.18	-46.85	-40.00	-11.18	-4.33	Peak	Vertical
2	2346.000	-44.86	-44.66	-13.00	-31.86	-0.20	Peak	Vertical

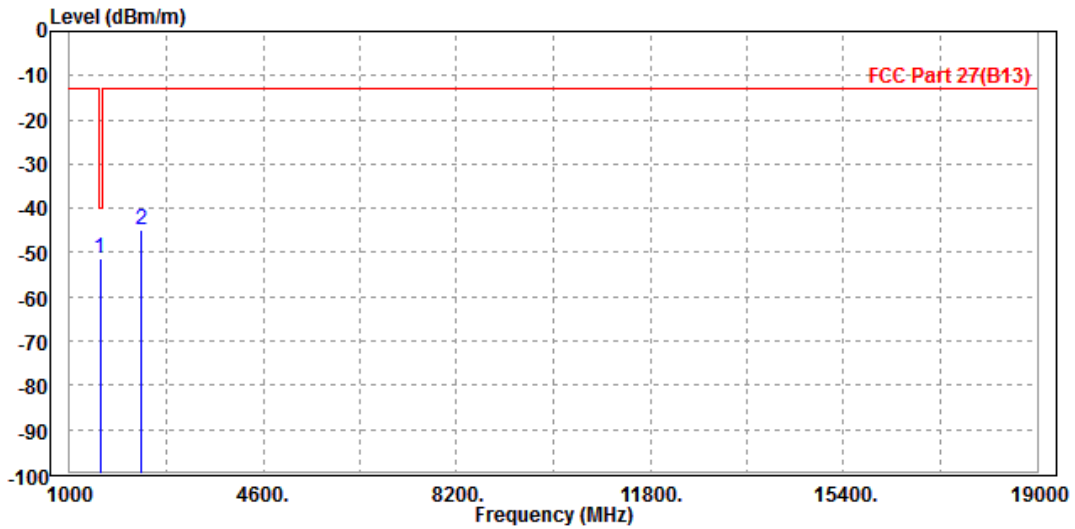



CH 23273

MODE	TX channel 23273	FREQUENCY RANGE	Above 1000MHz
ENVIRONMENTAL CONDITIONS	23deg. C, 70%RH	INPUT POWER	DC 5V from adapter
TESTED BY	Star Le		
ANTENNA POLARITY & TEST DISTANCE: HORIZONTAL AT 3 M			

	Freq	Level	Read Level	Limit Line	Over Limit	Factor	Remark	Pol/Phase
	MHz	dBm/m	dBm	dBm/m	dB	dB/m		
1	PP 1564.000	-51.97	-47.64	-40.00	-11.97	-4.33	Peak	Vertical
2	2353.000	-44.77	-44.57	-13.00	-31.77	-0.20	Peak	Vertical

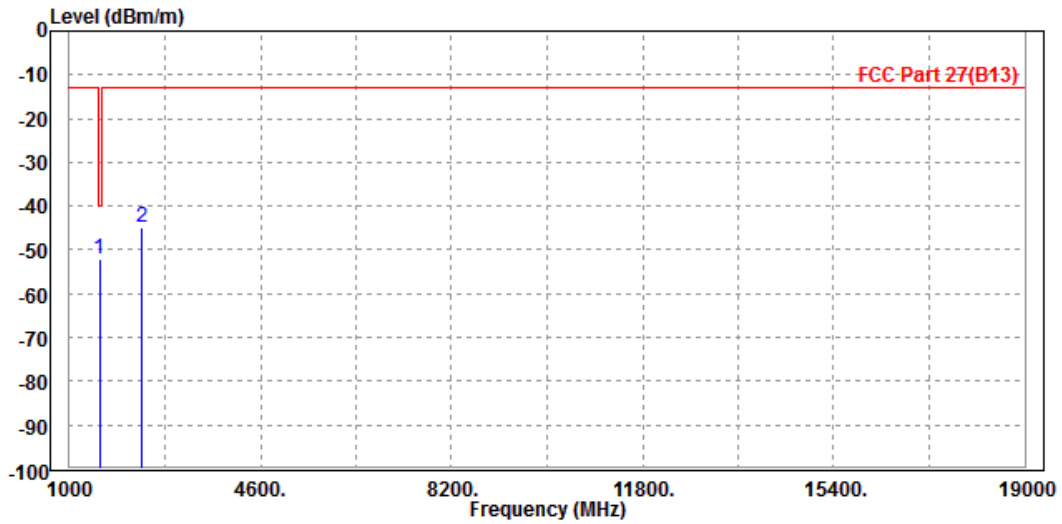



MODE	TX channel 23273	FREQUENCY RANGE	Above 1000MHz
ENVIRONMENTAL CONDITIONS	23deg. C, 70%RH	INPUT POWER	DC 5V from adapter
TESTED BY	Star Le		
ANTENNA POLARITY & TEST DISTANCE: VERTICAL AT 3 M			

		Freq	Level	Read Level	Limit Line	Over Limit	Factor	Remark	Pol/Phase
		MHz	dBm/m	dBm	dBm/m	dB	dB/m		
1	PP	1572.000	-60.68	-56.42	-40.00	-20.68	-4.26	Peak	Vertical
2		2353.500	-48.77	-48.57	-13.00	-35.77	-0.20	Peak	Vertical

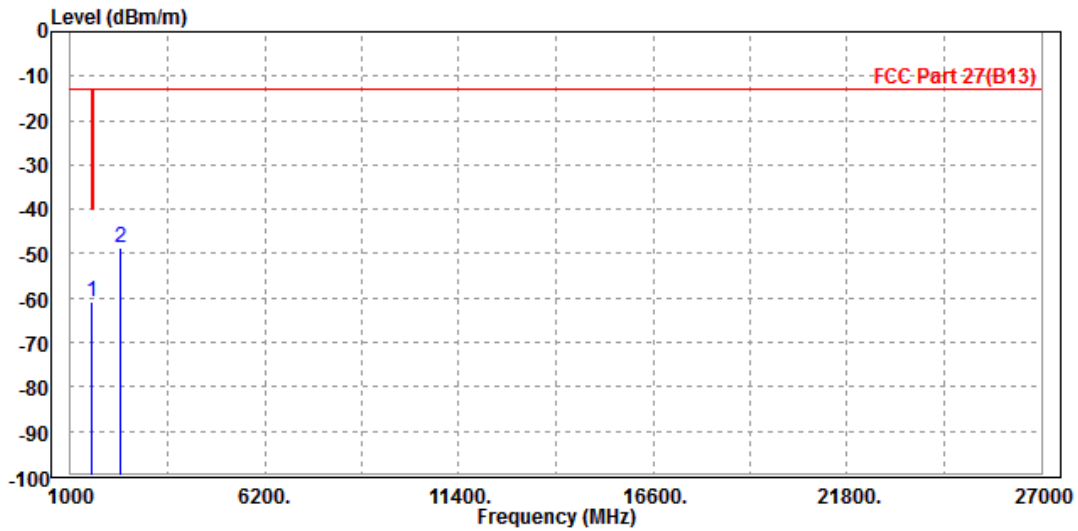



5 INFORMATION ON THE TESTING LABORATORIES

We, BV 7Layers Communications Technology (Shenzhen) Co. Ltd, were founded in 2015 to provide our best service in EMC, Radio, and Telecom. Our laboratories are accredited and approved according to ISO/IEC 17025.

If you have any comments, please feel free to contact us at the following:

Shenzhen EMC/RF Lab:

Tel: +86 755 8869 6566

Fax: +86 755 8869 6577

Email: customerservice.dg@cn.bureauveritas.com

Web Site: www.adt.com.tw

The address and road map of all our labs can be found in our web site also.



6 APPENDIX A – MODIFICATIONS RECORDERS FOR ENGINEERING CHANGES TO THE EUT BY THE LAB

No modifications were made to the EUT by the lab during the test.

---END---