

TEST REPORT



Applicant	Particle Industries, Inc
Address	325 9th St, San Francisco, CA 94103 USA, 415-319-1553

Manufacturer or Supplier	Particle Industries, Inc	
Address	325 9th St, San Francisco, CA 94103 USA, 415-319-1553	
Product	M SoM	
Brand Name	Particle	
Model	M524	
Additional Model & Model Difference	N/A	
Date of tests	Jan. 11, 2024 ~ Feb. 23, 2024	

The submitted sample of the above equipment has been tested according to the requirements of the following standards:

EN 300 328 V2.2.2 (2019-07)

CONCLUSION: The submitted sample was found to COMPLY with the test requirement

<p>Tested by Lucas Chen Project Engineer / EMC Department</p>	<p>Approved by Glyn He Assistant Manager / EMC Department</p>
	
<p>Date: Mar. 05, 2024</p>	

This report is governed by, and incorporates by reference, the Conditions of Testing as posted at the date of issuance of this report at <http://www.bureauveritas.com/home/about-us/our-business/cps/about-us/terms-conditions/> and is intended for your exclusive use. Any copying or replication of this report to or for any other person or entity, or use of our name or trademark, is permitted only with our prior written permission. This report sets forth our findings solely with respect to the test samples identified herein. The results set forth in this report are not indicative or representative of the quality or characteristics of the lot from which a test sample was taken or any similar or identical product unless specifically and expressly noted. Our report includes all of the tests requested by you and the results thereof based upon the information that you provided to us. Measurement uncertainty is only provided upon request for accredited tests. Statements of conformity are based on simple acceptance criteria without taking measurement uncertainty into account, unless otherwise requested in writing. You have 60 days from date of issuance of this report to notify us of any material error or omission caused by our negligence or if you require measurement uncertainty; provided, however, that such notice shall be in writing and shall specifically address the issue you wish to raise. A failure to raise such issue within the prescribed time shall constitute your unqualified acceptance of the completeness of this report, the tests conducted and the correctness of the report contents.



TABLE OF CONTENTS

RELEASE CONTROL RECORD 4

1. SUMMARY OF TEST RESULTS 5

1.1. TEST INSTRUMENTS 6

1.2. MEASUREMENT UNCERTAINTY 8

1.3. MAXIMUM MEASUREMENT UNCERTAINTY 8

2. GENERAL INFORMATION..... 9

2.1. GENERAL DESCRIPTION OF EUT 9

2.2. DESCRIPTION OF TEST MODES 10

2.2.1. TEST MODE APPLICABILITY AND TESTED CHANNEL DETAIL.....11

2.3. GENERAL DESCRIPTION OF APPLIED STANDARDS 14

2.4. DESCRIPTION OF SUPPORT UNITS 14

3 TEST PROCEDURES AND RESULTS 15

TRANSMITTER PARAMETERS 15

3.1. RF OUTPUT POWER 15

3.1.1. LIMITS OF RF OUTPUT POWER 15

3.1.2. TEST PROCEDURE 15

3.1.3. DEVIATION FROM TEST STANDARD 15

3.1.4. TEST SETUP 15

3.1.5. TEST RESULTS 16

3.2. POWER SPECTRAL DENSITY 17

3.2.1. LIMIT OF POWER SPECTRAL DENSITY 17

3.2.2. TEST PROCEDURE 17

3.2.3. DEVIATION FROM TEST STANDARD 17

3.2.4. TEST SETUP 17

3.2.5. TEST RESULTS 18

3.3. OCCUPIED CHANNEL BANDWIDTH 19

3.3.1. LIMIT OF OCCUPIED CHANNEL BANDWIDTH..... 19

3.3.2. TEST PROCEDURE 19

3.3.3. DEVIATION FROM TEST STANDARD 19

3.3.4. TEST SETUP 19

3.3.5. TEST RESULTS 20

3.4. TRANSMITTER UNWANTED EMISSIONS IN THE OUT-OF-BAND DOMAIN 21

3.4.1. LIMITS OF TRANSMITTER UNWANTED EMISSIONS IN THE OUT-OF-BAND DOMAIN
21

3.4.2. TEST PROCEDURE 21

3.4.3. DEVIATION FROM TEST STANDARD 21

3.4.4. TEST SETUP 22

3.4.5. TEST RESULTS 22

3.5. TRANSMITTER SPURIOUS EMISSIONS..... 23

3.5.1. LIMITS OF TRANSMITTER SPURIOUS EMISSIONS..... 23

3.5.2. TEST PROCEDURE 23

3.5.3. DEVIATION FROM TEST STANDARD 24

3.5.4. TEST SETUP 24

3.5.5. TEST RESULTS 25

RECEIVER PARAMETERS 30

3.6. RECEIVER SPURIOUS RADIATION 30

3.6.1. LIMITS OF RECEIVER SPURIOUS RADIATION 30

3.6.2. TEST PROCEDURE 30



**BUREAU
VERITAS**

Test Report No.: RE2312WDG0148-1

3.6.3.	DEVIATION FROM TEST STANDARD	30
3.6.4.	TEST SETUP	30
3.6.5.	TEST RESULTS	31
3.7.	RECEIVER BLOCKING	36
3.7.1.	LIMITS OF RECEIVER BLOCKING	36
3.7.2.	TEST PROCEDURE	37
3.7.3.	DEVIATION FROM TEST STANDARD	37
3.7.4.	TEST SETUP CONFIGURATION	38
3.7.5.	TEST RESULT	39
4	PHOTOGRAPHS OF THE TEST CONFIGURATION	40
5	APPENDIX A – MODIFICATIONS RECORDERS FOR ENGINEERING CHANGES TO THE EUT BY THE LAB	42



Test Report No.: RE2312WDG0148-1

RELEASE CONTROL RECORD

ISSUE NO.	REASON FOR CHANGE	DATE ISSUED
RE2312WDG0148-1	Original release	Mar. 05, 2024

1. SUMMARY OF TEST RESULTS

The EUT has been tested according to the following specifications:

EN 300 328 V2.2.2		
Clause	Test Parameter	Results
TRANSMITTER PARAMETERS		
4.3.2.2	RF Output Power	Pass
4.3.2.3	Power Spectral Density	Pass
4.3.2.6	Adaptivity	Not Applicable (Note)
4.3.2.7	Occupied Channel Bandwidth	Pass
4.3.2.8	Transmitter unwanted emission in the OOB domain	Pass
4.3.2.9	Transmitter unwanted emissions in the spurious domain	Pass
4.3.2.12	Geo-location capability	Not Applicable
RECEIVER PARAMETERS		
4.3.2.10	Receiver Spurious Emissions	Pass
4.3.2.11	Receiver Blocking	Pass

Note: These requirements do not apply for equipment with a maximum declared RF Output power of less than 10 dBm EIRP or for equipment when operating in a mode where the RF Output power is less than 10 dBm EIRP.

1.1. TEST INSTRUMENTS

Equipment	Manufacturer	Model No.	Serial No.	Next Cal.
EMI Test Receiver	Rohde&Schwarz	ESU40	100449	Jan. 02, 25
Signal and Spectrum Analyzer	Rohde&Schwarz	FSV40	101094	Jan. 01, 25
Trilog-Broadband Antenna	SCHWARZBECK	VULB 9168	9168-554	Jan. 08, 25
Horn Antenna	ETS-Lindgren	3117	00062558	Apr.01, 24
GPS Generator+ Antenna	TOJOIN	GNSS-5000A	E1-010119	N/A
3m Semi-anechoic Chamber	ETS-LINDGREN	9m*6m*6m	NSEMC003	May. 20, 24
Test Software	ADT	ADT_Radiated_V7.6.15.9.2	N/A	N/A
Test software	ADT	ADT_RF Test Software V6.6.5.3	N/A	N/A
Horn Antenna (15GHz-40GHz)	SCHWARZBECK	BBHA 9170	BBHA9170147	Apr. 01, 24
Amplifier	Burgeon	BPA-530	100220	Mar. 06, 24
Broadband Preamplifier (1GHz~18GHz)	SCHWARZBECK	BBV9718	305	Apr. 24, 24
Pre-Amplifier (18GHz-40GHz)	EMCI	EMC 184045	980102	Jan. 02 25
Power Sensor	Keysight	U2021XA	MY57320002	May. 11, 24
Humid & Temp Programmable Tester	Haida	HD-225T	1108072001	Oct. 15, 24
Oscilloscope	Agilent	DSO9254A	MY51260160	Jul. 11, 24
Signal and Spectrum Analyzer	Rohde&Schwarz	FSV7	102331	Apr 05, 24
Spectrum Analyzer	Keysight	N9020A	MY55400499	Jan. 01, 25
MXG-B RF Vector Signal Generator	Keysight	N5182B	MY56200288	Jul. 11, 24
Wireless Connectivity Tester	Rohde&Schwarz	CMW270	102426	Apr. 05, 24
Vector Signal Generator	Rohde&Schwarz	SMBV100A	257579	Oct. 15, 24
Attenuator	MINI	BW-S10W2+	S130129FGE2	N/A

NOTES:

1. The test was performed in 966 Chamber and RF Oven room.
2. The calibration interval of the above test instruments is 12 months, and the calibrations are traceable to CEPREI/CHINA, GRGT/CHINA and NIM/CHINA.
3. The horn antenna is used only for the measurement of emission frequency above 1GHz if tested.

For Receiver Blocking test and Adaptivity test:

Equipment	Manufacturer	Model No.	Serial No.	Next Cal.
Wireless Connectivity Tester	Rohde&Schwarz	CMW270	102426	Apr. 05, 24
Signal Analyzer	Rohde&Schwarz	FSV7	102331	Apr. 05, 24
Spectrum Analyzer	Keysight	N9020A	MY55400499	Jan. 01, 25
Signal Generator	Agilent	N5183A	MY50140980	Jul. 23, 24
MXG-B RF Vector Signal Generator	Keysight	N5182B	MY56200288	Jul. 11, 24
Power Sensor	Keysight	U2021XA	MY57320002	May. 11, 24
Vector Signal Generator	Rohde&Schwarz	SMBV100A	257579	Oct. 15, 24
Agile Signal Generator	Agilent	8645A	Agilent	N/A
Shield Box	TOJOIN	MS4345-C	SZA18A 3038	N/A
Attenuator	TOJOIN	CHB-8-90-1-B 50SMA	0803002	N/A
COM Power Splitter	TOJOIN	PS-TX-2B	020801	N/A
COM Power Splitter	TOJOIN	PS-TX-2B	020802	N/A
Test software	TonScend	JS1120-3-1	V2.6.88.0330	N/A

NOTES:

1. The test was performed in RF Oven room.
2. The calibration interval of the above test instruments is 12 months, and the calibrations are traceable to CEPREI/CHINA, GRGT/CHINA and NIM/CHINA.

1.2. MEASUREMENT UNCERTAINTY

Where relevant, the following measurement uncertainty levels have been estimated for tests performed on the EUT:

This uncertainty represents an expanded uncertainty expressed at approximately the 95% confidence level using a coverage factor of $k=2$.

Parameter	Uncertainty
Occupied Channel Bandwidth	$\pm 1.132 \%$
RF output power, conducted	$\pm 0.56\text{dB}$
Power Spectral Density, conducted	$\pm 1.017\text{dB}$
Unwanted Emissions, conducted	$\pm 1.017\text{dB}$
All emissions, radiated	$\pm 4.84\text{dB}$
Temperature	$\pm 0.23^\circ\text{C}$
Supply voltages	$\pm 0.01 \%$
Time	$\pm 4 \%$

1.3. MAXIMUM MEASUREMENT UNCERTAINTY

For the test methods, according to ETSI EN 300 328 standard, the measurement uncertainty figures shall be calculated in accordance with ETR 100 028-1 [4] and shall correspond to an expansion factor (coverage factor) $k = 1,96$ or $k = 2$ (which provide confidence levels of respectively 95 % and 95,45 % in the case where the distributions characterizing the actual measurement uncertainties are normal (Gaussian)).

Maximum measurement uncertainty

Parameter	Uncertainty
Occupied Channel Bandwidth	$\pm 5 \%$
RF output power, conducted	$\pm 1,5 \text{ dB}$
Power Spectral Density, conducted	$\pm 3 \text{ dB}$
Unwanted Emissions, conducted	$\pm 3 \text{ dB}$
All emissions, radiated	$\pm 6 \text{ dB}$
Temperature	$\pm 3 \text{ }^\circ\text{C}$
Supply voltages	$\pm 3 \%$
Time	$\pm 5 \%$



2. GENERAL INFORMATION

2.1. GENERAL DESCRIPTION OF EUT

PRODUCT	M SoM
TEST MODEL	M524
ADDITIONAL MODEL	N/A
NOMINAL VOLTAGE	VCC: 3.8V. 3V3:3.3V
OPERATING TEMPERATURE RANGE	-35 ~ +75°C
MODULATION TECHNOLOGY	DTS
MODULATION TYPE	BT-LE GFSK (1, 2 Mbps)
OPERATING FREQUENCY	2402MHz-2480MHz
ADPTIVE/NON-ADPTIVE	<input type="checkbox"/> non-adaptive Equipment <input checked="" type="checkbox"/> adaptive Equipment without the possibility to switch to a non-adaptive mode <input type="checkbox"/> adaptive Equipment which can also operate in a non-adaptive mode
EIRP (MAX.)	9.32dBm
ANTENNA TYPE	PCB Antenna, 3dBi Gain
CABLE SUPPLIED	N/A

Notes:

1. The above EUT information is declared by manufacturer and for more detailed features description, please refer to the manufacturer's specifications or user's manual.
2. For the test results, the EUT had been tested with all conditions, but only the worst case was shown in test report.
3. Please refer to the EUT photo document (Reference No.: W7L-P23120016) for detailed product photo.
4. The EUT provides completed transmitters and receivers, the EUT uses only one antenna at any time.

MODULATION MODE	TX FUNCTION
BLE (1&2Mbps)	1TX/1RX

2.2. DESCRIPTION OF TEST MODES

40 channels are provided to BT-LE GFSK (1 & 2Mbps):

CHANNEL	FREQ. (MHZ)	CHANNEL	FREQ. (MHZ)	CHANNEL	FREQ. (MHZ)	CHANNEL	FREQ. (MHZ)
0	2402	10	2422	20	2442	30	2462
1	2404	11	2424	21	2444	31	2464
2	2406	12	2426	22	2446	32	2466
3	2408	13	2428	23	2448	33	2468
4	2410	14	2430	24	2450	34	2470
5	2412	15	2432	25	2452	35	2472
6	2414	16	2434	26	2454	36	2474
7	2416	17	2436	27	2456	37	2476
8	2418	18	2438	28	2458	38	2478
9	2420	19	2440	29	2460	39	2480



2.2.1. TEST MODE APPLICABILITY AND TESTED CHANNEL DETAIL

EUT CONFIGURE MODE	APPLICABLE TO								DESCRIPTION
	ROP	PSD	AD	OCB	OOB	SE<1G	SE≥1G	RB	
A	√	√	-	√	√	√	√	√	Powered by DC 3.8V from SOM Mini SYS test board with BT link

- Where **ROP**: RF Output Power **PSD**: Power Spectral Density
AD: Adaptivity (Channel Access Mechanism) **OCB**: Occupied Channel Bandwidth
OOB: Transmitter unwanted emission in the out-of-band domain
SE<1G: Spurious Emissions below 1GHz **SE≥1G**: Spurious Emissions above 1GHz
RB: Receiver Blocking

RF OUTPUT POWER TEST:

- Pre-Scan has been conducted to determine the worst-case mode from all possible combinations between available modulations, data rates and antenna ports (if EUT with antenna diversity architecture).
- Following channel(s) was (were) selected for the final test as listed below.

MODE	AVAILABLE CHANNEL	TESTED CHANNEL	MODULATION TECHNOLOGY	MODULATION TYPE	DATA RATE (Mbps)
BT-LE	0 to 39	0,19, 39	DTS	GFSK	1.0
BT-LE	0 to 39	0,19, 39	DTS	GFSK	2.0

POWER SPECTRAL DENSITY TEST:

- Pre-Scan has been conducted to determine the worst-case mode from all possible combinations between available modulations, data rates and antenna ports (if EUT with antenna diversity architecture).
- Following channel(s) was (were) selected for the final test as listed below.

MODE	AVAILABLE CHANNEL	TESTED CHANNEL	MODULATION TECHNOLOGY	MODULATION TYPE	DATA RATE (Mbps)
BT-LE	0 to 39	0,19, 39	DTS	GFSK	1.0
BT-LE	0 to 39	0,19, 39	DTS	GFSK	2.0



OCCUPIED CHANNEL BANDWIDTH TEST:

- Pre-Scan has been conducted to determine the worst-case mode from all possible combinations between available modulations, data rates and antenna ports (if EUT with antenna diversity architecture).
- Following channel(s) was (were) selected for the final test as listed below.

MODE	AVAILABLE CHANNEL	TESTED CHANNEL	MODULATION TECHNOLOGY	MODULATION TYPE	DATA RATE (Mbps)
BT-LE	0 to 39	0, 39	DTS	GFSK	1.0
BT-LE	0 to 39	0, 39	DTS	GFSK	2.0

TRANSMITTER UNWANTED EMISSION IN THE OUT-OF-BAND DOMAIN TEST:

- Pre-Scan has been conducted to determine the worst-case mode from all possible combinations between available modulations, data rates and antenna ports (if EUT with antenna diversity architecture).
- Following channel(s) was (were) selected for the final test as listed below.

MODE	AVAILABLE CHANNEL	TESTED CHANNEL	MODULATION TECHNOLOGY	MODULATION TYPE	DATA RATE (Mbps)
BT-LE	0 to 39	0, 39	DTS	GFSK	1.0
BT-LE	0 to 39	0, 39	DTS	GFSK	2.0

SPURIOUS EMISSIONS TEST (BELOW 1 GHz):

- Pre-Scan has been conducted to determine the worst-case mode from all possible combinations between available modulations, data rates and antenna ports (if EUT with antenna diversity architecture).
- Following channel(s) was (were) selected for the final test as listed below.

MODE	AVAILABLE CHANNEL	TESTED CHANNEL	MODULATION TECHNOLOGY	MODULATION TYPE	DATA RATE (Mbps)
BT-LE	0 to 39	39	DTS	GFSK	1.0
BT-LE	0 to 39	39	DTS	GFSK	2.0

For the test results, only the worst case was shown in test report.

SPURIOUS EMISSIONS TEST (ABOVE 1 GHz):

- Pre-Scan has been conducted to determine the worst-case mode from all possible combinations between available modulations, data rates and antenna ports (if EUT with antenna diversity architecture).
- Following channel(s) was (were) selected for the final test as listed below.

MODE	AVAILABLE CHANNEL	TESTED CHANNEL	MODULATION TECHNOLOGY	MODULATION TYPE	DATA RATE (Mbps)
BT-LE	0 to 39	0, 39	DTS	GFSK	1.0
BT-LE	0 to 39	39	DTS	GFSK	2.0

For the test results, only the worst case was shown in test report.



RECEIVER BLOCKING TEST:

Following channel(s) was (were) selected for the final test as listed below.

MODE	AVAILABLE CHANNEL	TESTED CHANNEL	MODULATION TECHNOLOGY	MODULATION TYPE	DATA RATE (Mbps)
BT-LE	0 to 39	0, 39	DTS	GFSK	1.0

TEST CONDITION:

APPLICABLE TO	ENVIRONMENTAL CONDITIONS	INPUT POWER	TESTED BY
ROP	25deg. C, 60%RH	DC 3.8V from SOM Mini SYS test board	Vincent
PSD	25deg. C, 60%RH	DC 3.8V from SOM Mini SYS test board	Vincent
AD	-	-	-
OCB	25deg. C, 60%RH	DC 3.8V from SOM Mini SYS test board	Vincent
OOB	25deg. C, 60%RH	DC 3.8V from SOM Mini SYS test board	Vincent
SE<1G	27deg. C, 56%RH	DC 3.8V from SOM Mini SYS test board	Stalker
SE≥1G	27deg. C, 56%RH	DC 3.8V from SOM Mini SYS test board	Stalker
RB	25deg. C, 60%RH	DC 3.8V from SOM Mini SYS test board	Yoyo

2.3. GENERAL DESCRIPTION OF APPLIED STANDARDS

The EUT is a RF product, according to the specifications of the manufacturers. It must comply with the requirements of the following standards:

EN 300 328 V2.2.2 (2019-07)

All test items have been performed and recorded as per the above standards.

2.4. DESCRIPTION OF SUPPORT UNITS

The EUT has been tested as an independent unit together with other necessary accessories or support units. The following support units or accessories were used to form a representative test configuration during the tests.

NO.	PRODUCT	BRAND	MODEL NO.	SERIAL NO.	FCC ID
1	Notebook	DELL	Inspiron 13-7378	GMSJZD2	N/A
2	SOM Mini SYS test board	N/A	V0.8	N/A	N/A
3	Adaptor	SONY	AC-UUD12	190112010051	N/A

NO.	SIGNAL CABLE DESCRIPTION OF THE ABOVE SUPPORT UNITS
1	AC Line: Unshielded, Detachable 0.8m; DC Line: Unshielded, Non-detachable 1.8m USB Cable: Shielded, Detachable, 0.5m
2	N/A
3	USB Cable: Shielded, Detachable, 0.5m

3 TEST PROCEDURES AND RESULTS

TRANSMITTER PARAMETERS

3.1. RF OUTPUT POWER

3.1.1. LIMITS OF RF OUTPUT POWER

CONDITION	FREQUENCY BAND	LIMIT (e.i.r.p.)
Under all test conditions	2400 ~ 2483.5 MHz	AV: 20dBm

3.1.2. TEST PROCEDURE

Refer to chapter 5.4.2.2 of ETSI EN 300 328 V2.2.2.

Measurement	
<input checked="" type="checkbox"/> Conducted measurement	<input type="checkbox"/> Radiated measurement

3.1.3. DEVIATION FROM TEST STANDARD

No deviation.

3.1.4. TEST SETUP

The measurement was performed at both normal environmental conditions and at the extremes of the operating temperature. The measurement was performed at the lowest, the middle, and the highest channel. The equipment was configured to operate under its worst case situation with respect to output power. (In case of conducted measurements the transmitter shall be connected to the measuring equipment via a suitable attenuator.) Controlling software has been activated to set the EUT on specific channel and power level.



3.1.5. TEST RESULTS

TEST CONDITION			EIRP POWER (dBm)		
			(CH0) 2402 MHz	(CH19) 2440 MHz	(CH39) 2480 MHz
BT-LE GFSK(1Mbps)					
T _{nom} (°C)	+25	V _{nom} (V)	8.85	7.64	8.47
T _{min} (°C)	-35		9.32	7.83	8.62
T _{max} (°C)	+75		8.52	7.21	8.24

NOTE: 1. EIRP = Conducted output power + ANT Gain

TEST CONDITION			EIRP POWER (dBm)		
			(CH0) 2402 MHz	(CH19) 2440 MHz	(CH39) 2480 MHz
BT-LE GFSK(2Mbps)					
T _{nom} (°C)	+25	V _{nom} (V)	8.75	7.65	8.55
T _{min} (°C)	-35		9.02	7.75	8.71
T _{max} (°C)	+75		8.62	7.34	8.31

NOTE: 1. EIRP = Conducted output power + ANT Gain

3.2. POWER SPECTRAL DENSITY

3.2.1. LIMIT OF POWER SPECTRAL DENSITY

CONDITION	FREQUENCY BAND	LIMIT (e.i.r.p.)
Under normal conditions	2400 ~ 2483.5 MHz	10dBm / 1MHz

3.2.2. TEST PROCEDURE

Refer to chapter 5.4.3.2 of ETSI EN 300 328 V2.2.2.

Measurement Method	
<input checked="" type="checkbox"/> Conducted measurement	<input type="checkbox"/> Radiated measurement
<input checked="" type="checkbox"/> Option 1: For equipment with continuous and non-continuous transmissions	
<input type="checkbox"/> Option 2: For equipment with continuous transmission capability or for equipment operating (or with the capability to operate) with a constant duty cycle (e.g. Frame Based equipment)	

3.2.3. DEVIATION FROM TEST STANDARD

No deviation.

3.2.4. TEST SETUP

The measurement was performed at normal environmental conditions only. The measurement was performed at the lowest, the middle, and the highest channel. The equipment was configured to operate under its worst-case situation with respect to output power. (In case of conducted measurements the transmitter shall be connected to the measuring equipment via a suitable attenuator.) Controlling software has been activated to set the EUT on specific status.



3.2.5. TEST RESULTS

BT-LE GFSK (1Mbps)

CHANNEL	CHANNEL FREQUENCY (MHz)	POWER DENSITY (dBm/1MHz) (E.I.R.P)	LIMIT (dBm/1MHz) (E.I.R.P)	PASS/FAIL
0	2402.00	8.80	10	PASS
19	2440.00	7.58	10	PASS
39	2480.00	8.41	10	PASS

BT-LE GFSK (2Mbps)

CHANNEL	CHANNEL FREQUENCY (MHz)	POWER DENSITY (dBm/1MHz) (E.I.R.P)	LIMIT (dBm/1MHz) (E.I.R.P)	PASS/FAIL
0	2402.00	7.69	10	PASS
19	2440.00	6.59	10	PASS
39	2480.00	7.51	10	PASS

3.3. OCCUPIED CHANNEL BANDWIDTH

3.3.1. LIMIT OF OCCUPIED CHANNEL BANDWIDTH

CONDITION		LIMIT
All types of equipment		Shall fall completely within the band 2400 to 2483.5 MHz.
Additional requirement	For non-adaptive using wide band modulations other than FHSS system and e.i.r.p >10dBm.	Less than 20MHz
	For non-adaptive Frequency Hopping system and e.i.r.p >10dBm.	Less than 5MHz

3.3.2. TEST PROCEDURE

Refer to chapter 5.4.7.2 of ETSI EN 300 328 V2.2.2.

Measurement	
<input checked="" type="checkbox"/> Conducted measurement	<input type="checkbox"/> Radiated measurement

3.3.3. DEVIATION FROM TEST STANDARD

No deviation.

3.3.4. TEST SETUP

The measurement was performed at normal environmental conditions only. This measurement was performed at the lowest and the highest channel. The equipment was configured to operate under its worst-case situation with respect to output power. (In case of conducted measurements the transmitter shall be connected to the measuring equipment via a suitable attenuator.) Controlling software has been activated to set the EUT on specific status.



3.3.5. TEST RESULTS

BT-LE GFSK (1Mbps)

CHANNEL	CHANNEL FREQUENCY (MHz)	OCCUPIED BANDWIDTH (MHz)	Measured frequencies		LIMIT	PASS/FAIL
			FL (MHz)	FH (MHz)		
0	2402	1.03	2401.49	2402.52	FL > 2400 MHz and	PASS
39	2480	1.04	2479.48	2480.52	FH < 2483.5 MHz	

Note: FL is the lowest frequency of the 99% occupied bandwidth of power envelope.
FH is the highest frequency of the 99% occupied bandwidth of power envelope.

BT-LE GFSK (2Mbps)

CHANNEL	CHANNEL FREQUENCY (MHz)	OCCUPIED BANDWIDTH (MHz)	Measured frequencies		LIMIT	PASS/FAIL
			FL (MHz)	FH (MHz)		
0	2402	2.05	2400.99	2403.04	FL > 2400 MHz and	PASS
39	2480	2.05	2479	2481.05	FH < 2483.5 MHz	

Note: FL is the lowest frequency of the 99% occupied bandwidth of power envelope.
FH is the highest frequency of the 99% occupied bandwidth of power envelope.

3.4. TRANSMITTER UNWANTED EMISSIONS IN THE OUT-OF-BAND DOMAIN

3.4.1. LIMITS OF TRANSMITTER UNWANTED EMISSIONS IN THE OUT-OF-BAND DOMAIN

CONDITION	LIMIT
Under all test conditions	The transmitter unwanted emissions in the out-of-band domain but outside the allocated band, shall not exceed the values provided by the mask in below figure.

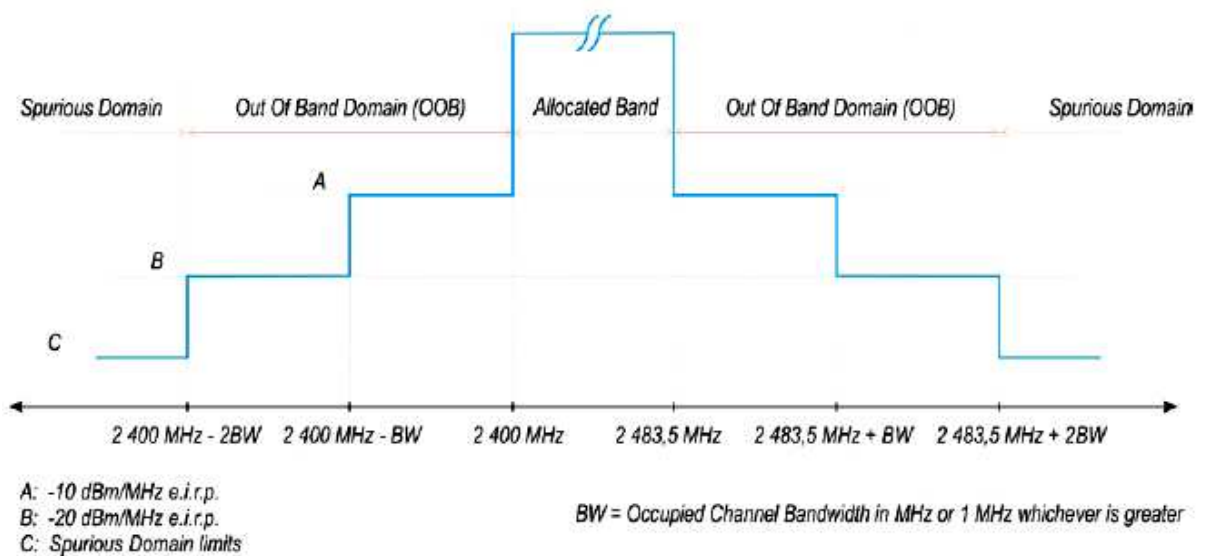

3.4.2. TEST PROCEDURE

Refer to chapter 5.4.8.2 of ETSI EN 300 328 V2.2.2.

Measurement	
<input checked="" type="checkbox"/> Conducted measurement	<input type="checkbox"/> Radiated measurement

3.4.3. DEVIATION FROM TEST STANDARD

No deviation.

3.4.4. TEST SETUP

The measurement was performed at normal environmental conditions only. This measurement was performed at the lowest and the highest channel. The equipment was configured to operate under its worst case situation with respect to output power. (In case of conducted measurements the transmitter shall be connected to the measuring equipment via a suitable attenuator.) The frequency has to be recorded for the right and left end above threshold of highest and lowest channel respectively.

3.4.5. TEST RESULTS

BT-LE GFSK (1Mbps)

CHANNEL FREQ.(MHz)			2402MHz				2480MHz			
TEST CONDITION			OOB Emission (MHz)				OOB Emission (MHz)			
			2398.97 ~ 2400		2397.94 ~ 2398.97		2483.5 ~ 2484.54		2484.54 ~ 2485.58	
Temperature	Voltage		Freq. (MHz)	Power (dBm)	Freq. (MHz)	Power (dBm)	Freq. (MHz)	Power (dBm)	Freq. (MHz)	Power (dBm)
Tnorm(°C)	+25	Normal	2399.50	-41.16	2398.47	-54.76	2484.00	-53.54	2485.03	-56.57
Limit (dBm/MHz)			-10.00		-20.00		-10.00		-20.00	
PASS/FAIL			PASS		PASS		PASS		PASS	

BT-LE GFSK (2Mbps)

CHANNEL FREQ.(MHz)			2402MHz				2480MHz			
TEST CONDITION			OOB Emission (MHz)				OOB Emission (MHz)			
			2397.95 ~ 2400		2395.9 ~ 2397.95		2483.5 ~ 2485.55		2485.55 ~ 2487.6	
Temperature	Voltage		Freq. (MHz)	Power (dBm)	Freq. (MHz)	Power (dBm)	Freq. (MHz)	Power (dBm)	Freq. (MHz)	Power (dBm)
Tnorm(°C)	+25	Normal	2399.50	-28.36	2397.45	-55.72	2484.00	-54.18	2486.05	-57.51
Limit (dBm/MHz)			-10.00		-20.00		-10.00		-20.00	
PASS/FAIL			PASS		PASS		PASS		PASS	

3.5. TRANSMITTER SPURIOUS EMISSIONS

3.5.1. LIMITS OF TRANSMITTER SPURIOUS EMISSIONS

Transmitter limits for narrowband spurious emissions:

Frequency Range	Maximum Power Limit (e.r.p. (≤ 1 GHz) e.i.r.p. (> 1 GHz))	Bandwidth
30 MHz to 47 MHz	-36dBm	100kHz
47 MHz to 74 MHz	-54dBm	100kHz
74 MHz to 87,5 MHz	-36dBm	100kHz
87,5 MHz to 118 MHz	-54dBm	100kHz
118 MHz to 174 MHz	-36dBm	100kHz
174 MHz to 230 MHz	-54dBm	100kHz
230 MHz to 470 MHz	-36dBm	100kHz
470 MHz to 694 MHz	-54dBm	100kHz
694 MHz to 1 GHz	-36dBm	100kHz
1GHz ~ 12.75GHz	-30dBm	1MHz

Note: These limits are e.r.p. for emissions up to 1 GHz and as e.i.r.p. for emissions above 1 GHz.

3.5.2. TEST PROCEDURE

Refer to chapter 5.4.9.2 of ETSI EN 300 328 V2.2.2.

Measurement	
<input type="checkbox"/> Conducted measurement	<input checked="" type="checkbox"/> Radiated measurement
<p>For Conducted measurement:</p> <p>The level of unwanted emissions shall be measured as their power in a specified load (conducted spurious emissions) and their effective radiated power when radiated by the cabinet or structure of the equipment with the antenna connector(s) terminated by a specified load (cabinet radiation).</p>	
<p>Conducted measurement (For equipment with multiple transmit chains):</p> <p><input type="checkbox"/> Option 1: The results for each of the transmit chains for the corresponding 1MHz segments shall be added and compared with the limits.</p> <p><input type="checkbox"/> Option 2: The results for each of the transmit chains shall be individually compared with the limits after these limits have been reduced by $10 \times \log(N)$ (number of active transmit chains)</p>	



Test Report No.: RE2312WDG0148-1

3.5.3. DEVIATION FROM TEST STANDARD

No deviation.

3.5.4. TEST SETUP

1. For the actual test configuration, please refer to the related Item in this test report (Photographs of the Test Configuration).
2. The equipment was configured to operate under its worst-case situation with respect to output power.
3. The measurement was performed at normal environmental conditions only. Controlling software has been activated to set the EUT on specific status.
4. This measurement was performed at the lowest and the highest channel.

3.5.5. TEST RESULTS

BELOW 1GHz WORST-CASE DATA

BT_LE-GFSK (1Mbps)

FREQUENCY RANGE	30MHz ~ 1GHz	OPERATING CHANNEL	39
------------------------	--------------	--------------------------	----

SPURIOUS EMISSION LEVEL				
Frequency (MHz)	Antenna Polarization	Level (dBm)	Limit (dBm)	Margin (dB)
107.86	H	-70.51	-54.00	-16.51
149.99	H	-70.45	-36.00	-34.45
191.99	H	-67.43	-54.00	-13.43
240.07	H	-66.82	-36.00	-30.82
515.97	H	-69.93	-54.00	-15.93
528.00	H	-69.92	-54.00	-15.92

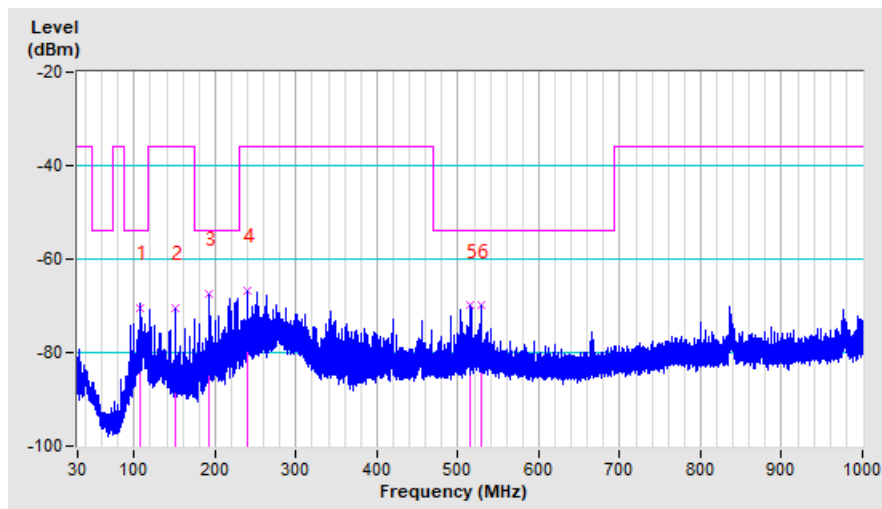

FREQUENCY RANGE	30MHz ~ 1GHz	OPERATING CHANNEL	39
------------------------	--------------	--------------------------	----

SPURIOUS EMISSION LEVEL				
Frequency (MHz)	Antenna Polarization	Level (dBm)	Limit (dBm)	Margin (dB)
95.96	V	-72.51	-54.00	-18.51
108.15	V	-70.44	-54.00	-16.44
149.99	V	-73.55	-36.00	-37.55
167.93	V	-68.84	-36.00	-32.84
240.01	V	-68.98	-36.00	-32.98
302.86	V	-69.99	-36.00	-33.99

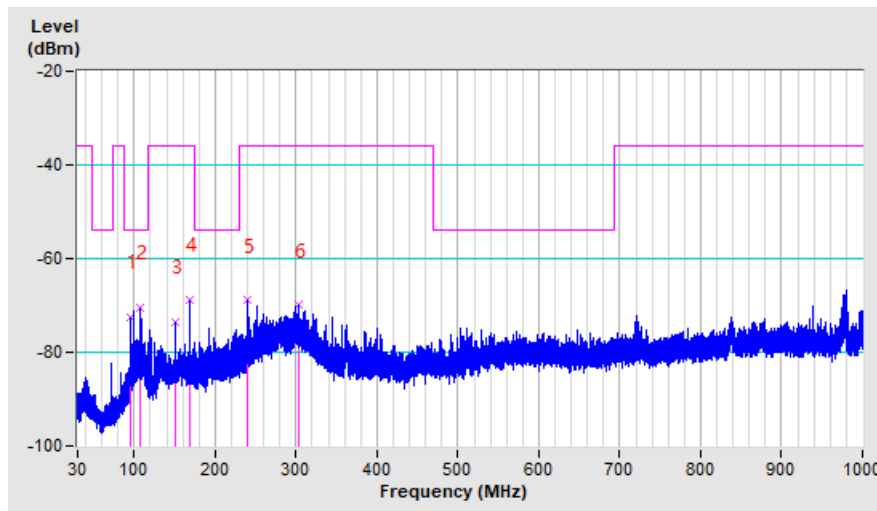



BELOW 1GHz WORST-CASE DATA

BT_LE-GFSK (2Mbps)

FREQUENCY RANGE	30MHz ~ 1GHz	OPERATING CHANNEL	39
------------------------	--------------	--------------------------	----

SPURIOUS EMISSION LEVEL				
Frequency (MHz)	Antenna Polarization	Level (dBm)	Limit (dBm)	Margin (dB)
107.96	H	-69.54	-54.00	-15.54
132.11	H	-67.56	-36.00	-31.56
168.06	H	-68.09	-36.00	-32.09
191.96	H	-68.62	-54.00	-14.62
264.16	H	-58.84	-36.00	-22.84
515.97	H	-66.04	-54.00	-12.04

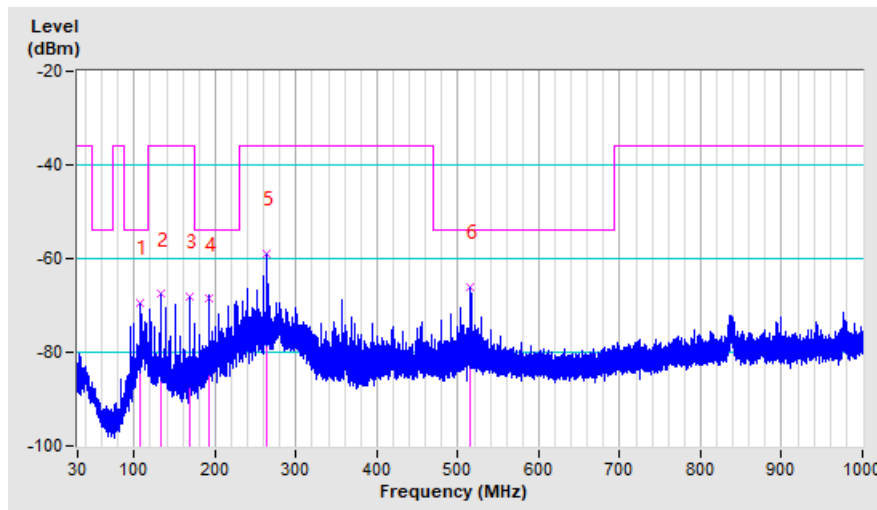

FREQUENCY RANGE	30MHz ~ 1GHz	OPERATING CHANNEL	39
------------------------	--------------	--------------------------	----

SPURIOUS EMISSION LEVEL				
Frequency (MHz)	Antenna Polarization	Level (dBm)	Limit (dBm)	Margin (dB)
95.96	V	-73.63	-54.00	-19.63
99.97	V	-73.28	-54.00	-19.28
107.83	V	-75.40	-54.00	-21.40
149.99	V	-76.04	-36.00	-40.04
191.96	V	-78.71	-54.00	-24.71
298.75	V	-68.78	-36.00	-32.78

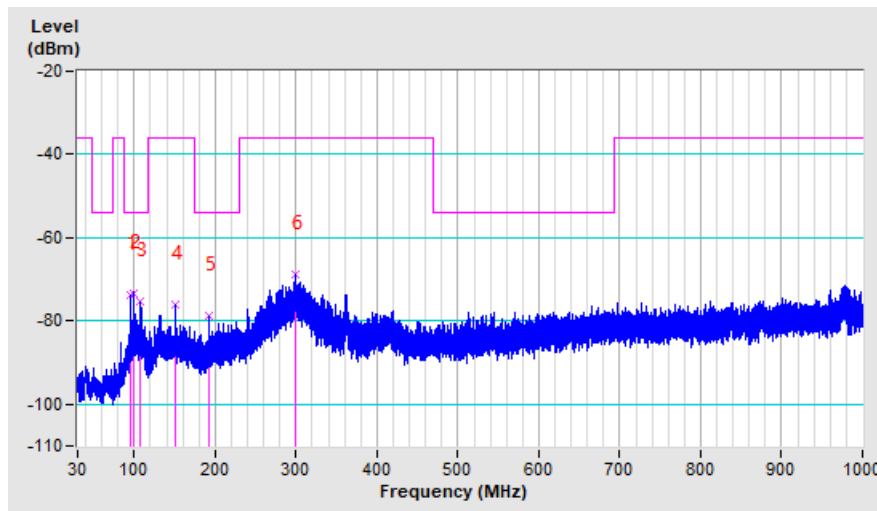



ABOVE 1GHz DATA

BT_LE-GFSK (1Mbps)

FREQUENCY RANGE	1GHz ~ 12.75GHz	OPERATING CHANNEL	0, 39
------------------------	-----------------	--------------------------	-------

SPURIOUS EMISSION LEVEL					
Channel	Frequency (MHz)	Antenna Polarization	Level (dBm)	Limit (dBm)	Margin (dB)
0	4804.00	H	-55.25	-30.00	-25.25
	4804.00	V	-55.25	-30.00	-25.25
	7206.00	H	-53.43	-30.00	-23.43
	7206.00	V	-52.18	-30.00	-22.18
39	4960.00	H	-56.28	-30.00	-26.28
	4960.00	V	-54.22	-30.00	-24.22
	7440.00	H	-53.39	-30.00	-23.39
	7440.00	V	-52.39	-30.00	-22.39

BT_LE-GFSK (2Mbps)

FREQUENCY RANGE	1GHz ~ 12.75GHz	OPERATING CHANNEL	0, 39
------------------------	-----------------	--------------------------	-------

SPURIOUS EMISSION LEVEL					
Channel	Frequency (MHz)	Antenna Polarization	Level (dBm)	Limit (dBm)	Margin (dB)
0	4804.00	H	-55.93	-30.00	-25.93
	4804.00	V	-56.04	-30.00	-26.04
	7206.00	H	-53.75	-30.00	-23.75
	7206.00	V	-53.79	-30.00	-23.79
39	4960.00	H	-54.67	-30.00	-24.67
	4960.00	V	-56.61	-30.00	-26.61
	7440.00	H	-51.47	-30.00	-21.47
	7440.00	V	-53.30	-30.00	-23.30

RECEIVER PARAMETERS

3.6. RECEIVER SPURIOUS RADIATION

3.6.1. LIMITS OF RECEIVER SPURIOUS RADIATION

Frequency Range	Maximum Power Limit (e.r.p. (≤ 1 GHz) e.i.r.p. (> 1 GHz))
30MHz ~ 1GHz	-57dBm
1GHz ~ 12.75GHz	-47dBm

Note: These limits are e.r.p. for emissions up to 1 GHz and as e.i.r.p. for emissions above 1 GHz.

3.6.2. TEST PROCEDURE

Refer to chapter 5.4.10.2 of ETSI EN 300 328 V2.2.2.

Measurement	
<input type="checkbox"/> Conducted measurement	<input checked="" type="checkbox"/> Radiated measurement
<p><u>For Conducted measurement:</u> The level of unwanted emissions shall be measured as their power in a specified load (conducted spurious emissions) and their effective radiated power when radiated by the cabinet or structure of the equipment with the antenna connector(s) terminated by a specified load (cabinet radiation).</p>	
<p><u>Conducted measurement (For equipment with multiple transmit chains):</u></p> <p><input type="checkbox"/> Option 1: The results for each of the transmit chains for the corresponding 1MHz segments shall be added and compared with the limits.</p> <p><input type="checkbox"/> Option 2: The results for each of the transmit chains shall be individually compared with the limits after these limits have been reduced by $10 \times \log(N)$ (number of active transmit chains)</p>	

3.6.3. DEVIATION FROM TEST STANDARD

No deviation.

3.6.4. TEST SETUP

1. For the actual test configuration, please refer to the related Item in this test report (Photographs of the Test Configuration).
2. Testing was performed when the equipment was in a receive-only mode.
3. The measurement was performed at normal environmental conditions only. Controlling software has been activated to set the EUT on specific status.
4. This measurement was performed at the lowest and the highest channel.



3.6.5. TEST RESULTS

RX BELOW 1GHz WORST-CASE DATA

BT_LE-GFSK (1Mbps)

FREQUENCY RANGE	30MHz ~ 1GHz	OPERATING CHANNEL	39
------------------------	--------------	--------------------------	----

SPURIOUS EMISSION LEVEL				
Frequency (MHz)	Antenna Polarization	Level (dBm)	Limit (dBm)	Margin (dB)
107.99	H	-66.69	-57.00	-9.69
149.99	H	-73.84	-57.00	-16.84
191.96	H	-72.95	-57.00	-15.95
240.01	H	-66.19	-57.00	-9.19
275.77	H	-67.50	-57.00	-10.50
504.04	H	-69.18	-57.00	-12.18

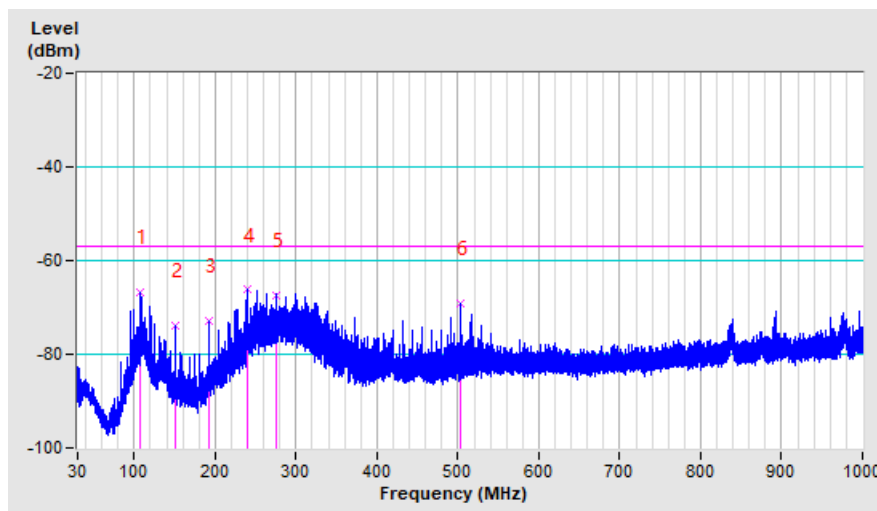

FREQUENCY RANGE	30MHz ~ 1GHz	OPERATING CHANNEL	39
------------------------	--------------	--------------------------	----

SPURIOUS EMISSION LEVEL				
Frequency (MHz)	Antenna Polarization	Level (dBm)	Limit (dBm)	Margin (dB)
107.89	V	-72.43	-57.00	-15.43
180.06	V	-71.50	-57.00	-14.50
191.96	V	-74.93	-57.00	-17.93
266.03	V	-64.23	-57.00	-7.23
299.85	V	-65.89	-57.00	-8.89
332.45	V	-69.90	-57.00	-12.90

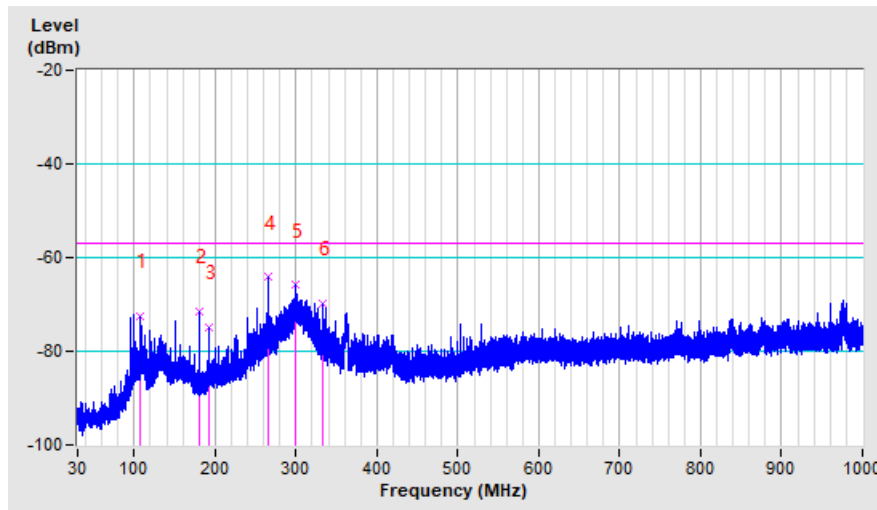



RX BELOW 1GHz WORST-CASE DATA

BT_LE-GFSK (2Mbps)

FREQUENCY RANGE	30MHz ~ 1GHz	OPERATING CHANNEL	39
------------------------	--------------	--------------------------	----

SPURIOUS EMISSION LEVEL				
Frequency (MHz)	Antenna Polarization	Level (dBm)	Limit (dBm)	Margin (dB)
107.92	H	-66.78	-57.00	-9.78
252.07	H	-65.77	-57.00	-8.77
275.90	H	-66.35	-57.00	-9.35
300.95	H	-66.28	-57.00	-9.28
324.10	H	-68.02	-57.00	-11.02
491.98	H	-64.53	-57.00	-7.53

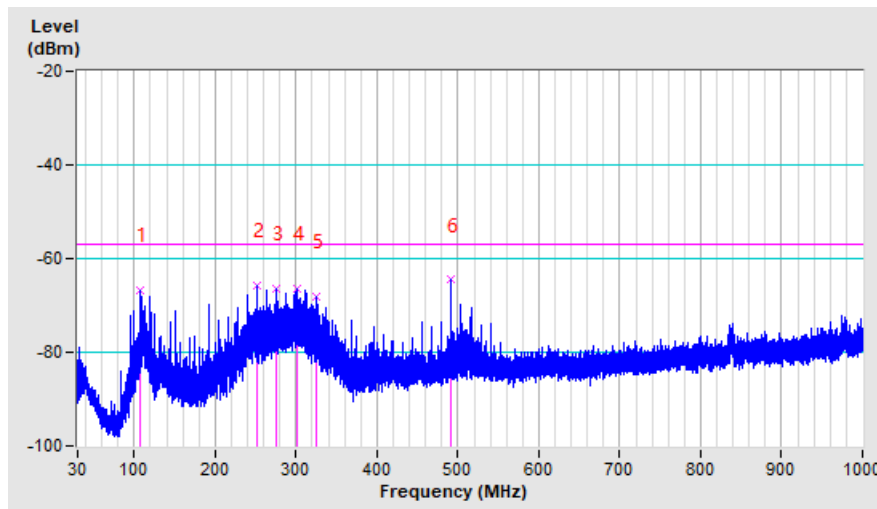

FREQUENCY RANGE	30MHz ~ 1GHz	OPERATING CHANNEL	39
------------------------	--------------	--------------------------	----

SPURIOUS EMISSION LEVEL				
Frequency (MHz)	Antenna Polarization	Level (dBm)	Limit (dBm)	Margin (dB)
99.97	V	-73.12	-57.00	-16.12
149.99	V	-72.63	-57.00	-15.63
192.02	V	-70.75	-57.00	-13.75
251.87	V	-73.10	-57.00	-16.10
300.05	V	-72.07	-57.00	-15.07
570.32	V	-74.02	-57.00	-17.02

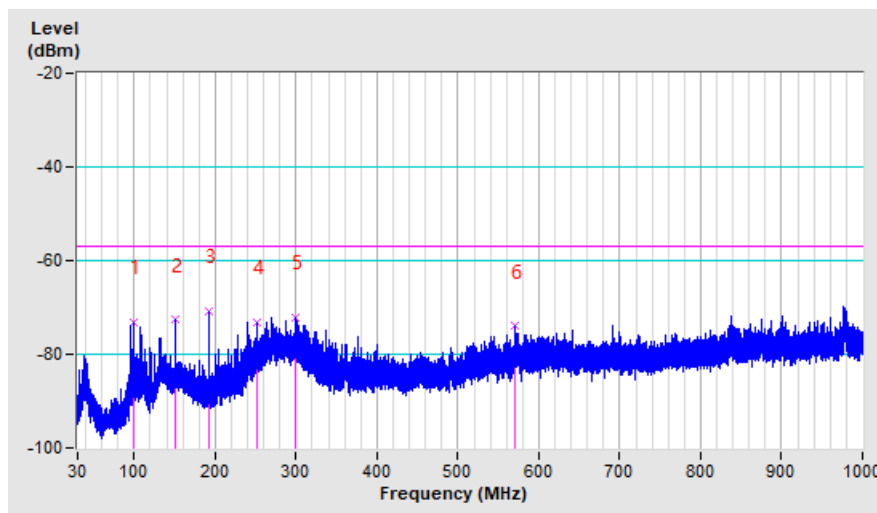



RX ABOVE 1GHz WORST CASE DATA

BT_LE-GFSK (1Mbps)

SPURIOUS EMISSION FREQUENCY RANGE	1GHz ~ 12.75GHz	OPERATING CHANNEL	0, 39
--	-----------------	--------------------------	-------

SPURIOUS EMISSION LEVEL					
Channel	Frequency (MHz)	Antenna Polarization	Level (dBm)	Limit (dBm)	Margin (dB)
0	4804.00	H	-56.92	-47.00	-9.92
	4804.00	V	-57.60	-47.00	-10.60
	7206.00	H	-57.93	-47.00	-10.93
	7206.00	V	-54.53	-47.00	-7.53
39	4960.00	H	-57.65	-47.00	-10.65
	4960.00	V	-58.88	-47.00	-11.88
	7440.00	H	-56.90	-47.00	-9.90
	7440.00	V	-57.70	-47.00	-10.70

3.7. RECEIVER BLOCKING

3.7.1. LIMITS OF RECEIVER BLOCKING

This requirement applies to all receiver categories.

Receiver Category		
<input type="checkbox"/> Category 1(EIRP>10dBm)	<input checked="" type="checkbox"/> Category 2(EIRP ≤ 10dBm)	<input type="checkbox"/> Category 3(EIRP ≤ 0dBm)
Minimum performance criterion	<input checked="" type="checkbox"/> PER ≤ 10%	
	<input type="checkbox"/> Alternative performance criteria (See note)	
Note: The manufacturer was declared the minimum performance criterion shall be no loss of the wireless transmission function needed for the intended use of the equipment.		

Receiver Category 1 Equipment			
Wanted signal mean power from companion device (dBm)(See note 1 and 4)	Blocking Signal Frequency (MHz)	Blocking Signal Power (dBm) (See note 4)	Type of blocking signal
(-133dBm+10xlog ₁₀ (OCBW) Or -68dBm whichever is less (See note 2)	2 380	-34	CW
	2 504		
(-139dBm+10xlog ₁₀ (OCBW) Or -74dBm whichever is less (See note 3)	2 300		
	2 330		
	2 360		
	2 524		
	2 584		
	2 674		
<p>NOTE 1: OCBW is in Hz.</p> <p>NOTE 2: In case of radiated measurements using a companion device and the level of the wanted signal from the companion device cannot be determined, a relative test may be performed using a wanted signal up to P_{min} + 26 dB where P_{min} is the minimum level of wanted signal required to meet the minimum performance criteria as defined in clause 4.3.1.12.3 in the absence of any blocking signal.</p> <p>NOTE 3: In case of radiated measurements using a companion device and the level of the wanted signal from the companion device cannot be determined, a relative test may be performed using a wanted signal up to P_{min} + 20 dB where P_{min} is the minimum level of wanted signal required to meet the minimum performance criteria as defined in clause 4.3.1.12.3 in the absence of any blocking signal.</p> <p>NOTE 4: The level specified is the level at the UUT receiver input assuming a 0 dBi antenna assembly gain. In case of conducted measurements, this level has to be corrected for the (in-band) antenna assembly gain (G). In case of radiated measurements, this level is equivalent to a power flux density (PFD) in front of the UUT antenna with the UUT being configured/positioned as recorded in clause 5.4.3.2.2.</p>			

Receiver Category 2 Equipment			
Wanted signal mean power from companion device (dBm)(See note 1 and 3)	Blocking Signal Frequency (MHz)	Blocking Signal Power (dBm) (See note 3)	Type of blocking signal
(-139dBm+10xlog ₁₀ (OCBW)+10dB) Or -74dBm+10dB whichever is less(See note 2)	2 380	-34	CW
	2 504		
	2 300		
	2 584		
NOTE 1: OCBW is in Hz. NOTE 2: In case of radiated measurements using a companion device and the level of the wanted signal from the companion device cannot be determined, a relative test may be performed using a wanted signal up to P _{min} + 26 dB where P _{min} is the minimum level of wanted signal required to meet the minimum performance criteria as defined in clause 4.3.1.12.3 in the absence of any blocking signal. NOTE 3: The level specified is the level at the UUT receiver input assuming a 0 dBi antenna assembly gain. In case of conducted measurements, this level has to be corrected for the (in-band) antenna assembly gain (G). In case of radiated measurements, this level is equivalent to a power flux density (PFD) in front of the UUT antenna with the UUT being configured/positioned as recorded in clause 5.4.3.2.2.			

Receiver Category 3 Equipment			
Wanted signal mean power from companion device (dBm) (See note 1 and 3)	Blocking Signal Frequency (MHz)	Blocking Signal Power (dBm) (See note 3)	Type of blocking signal
(-139dBm+10xlog ₁₀ (OCBW)+20dB) Or -74dBm+20dB whichever is less(See note 2)	2 380	-34	CW
	2 504		
	2 300		
	2 584		
NOTE 1: OCBW is in Hz. NOTE 2: In case of radiated measurements using a companion device and the level of the wanted signal from the companion device cannot be determined, a relative the test may be performed using a wanted signal up to P _{min} + 30 dB where P _{min} is the minimum level of wanted signal required to meet the minimum performance criteria as defined in clause 4.3.1.12.3 in the absence of any blocking signal. NOTE 3: The level specified is the level at the UUT receiver input assuming a 0 dBi antenna assembly gain. In case of conducted measurements, this level has to be corrected for the (in-band) antenna assembly gain (G). In case of radiated measurements, this level is equivalent to a power flux density (PFD) in front of the UUT antenna with the UUT being configured/positioned as recorded in clause 5.4.3.2.2.			

3.7.2. TEST PROCEDURE

Refer to chapter 5.4.11.2. of ETSI EN 300 328 V2.2.2.

Measurement	
<input checked="" type="checkbox"/> Conducted measurement	<input type="checkbox"/> Radiated measurement

3.7.3. DEVIATION FROM TEST STANDARD

No deviation.

3.7.4. TEST SETUP CONFIGURATION

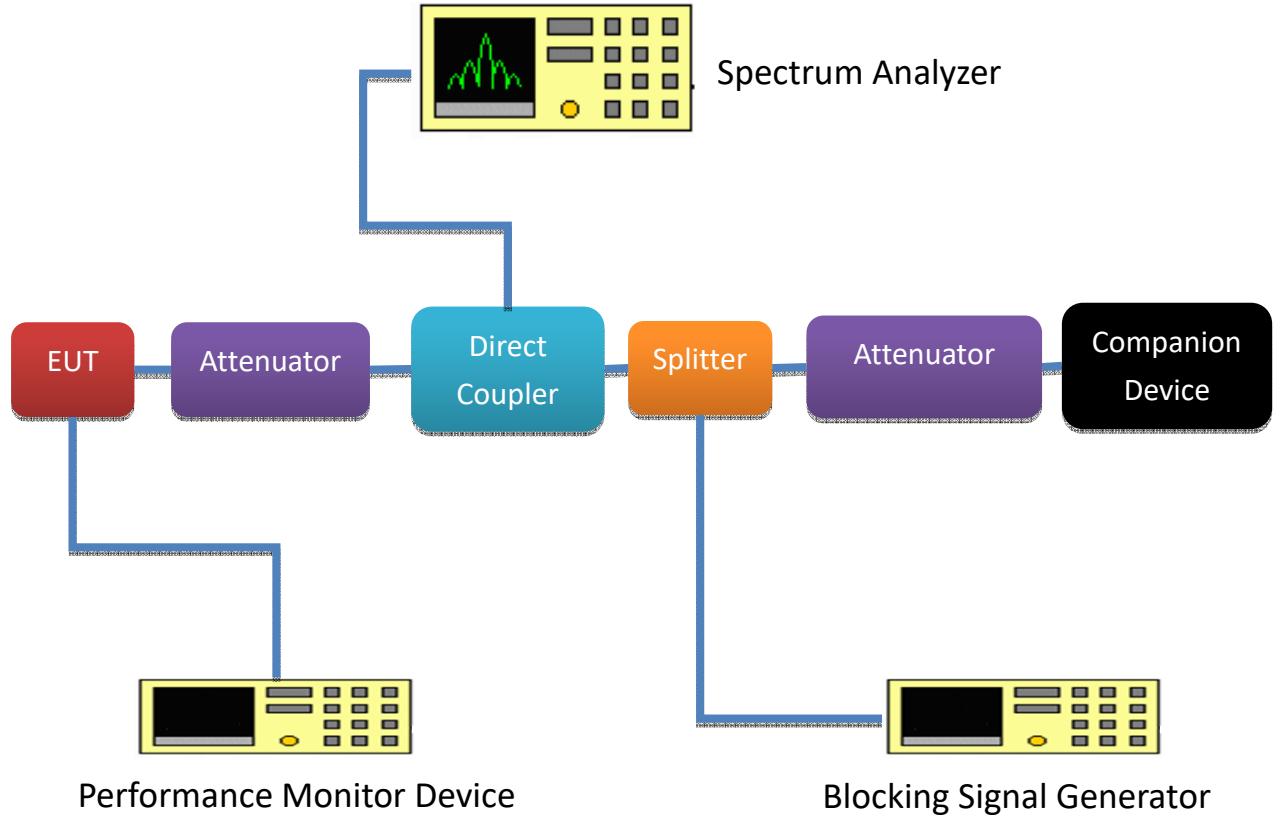

3.7.5. TEST RESULT

BTLE:

Receiver Category 2 Equipment

Receiver blocking performance when operating at the lowest operating channel(CH0)				
OCBW _{min} : 1.03MHz			antenna gain(G) : 3dBi	
The actual blocking signal power(Note1)			<input checked="" type="checkbox"/> at the antenna connector	
			<input type="checkbox"/> in front of the antenna	
Note1: For the conducted measurements , the level shall be corrected as follows: the actual blocking signal power = blocking signal power + antenna gain				
The actual wanted signal mean power from companion device (dBm)	Blocking signal frequency (MHz)	The actual blocking signal power (dBm)	PER(%)	Pass/Fail
-65.87	2300.0	-31	0.2	PASS
	2380.0		0.7	PASS

Receiver blocking performance when operating at the Highest operating channel(CH39)				
OCBW _{min} : 1.04MHz			antenna gain(G) : 3dBi	
The actual blocking signal power(Note1)			<input checked="" type="checkbox"/> at the antenna connector	
			<input type="checkbox"/> in front of the antenna	
Note1: For the conducted measurements , the level shall be corrected as follows: the actual blocking signal power = blocking signal power + antenna gain				
The actual wanted signal mean power from companion device (dBm)	Blocking signal frequency (MHz)	The actual blocking signal power (dBm)	PER(%)	Pass/Fail
-65.83	2504.0	-31	0.5	PASS
	2584.0		0.7	PASS

4 PHOTOGRAPHS OF THE TEST CONFIGURATION

SPURIOUS EMISSION TEST BELOW 1GHz

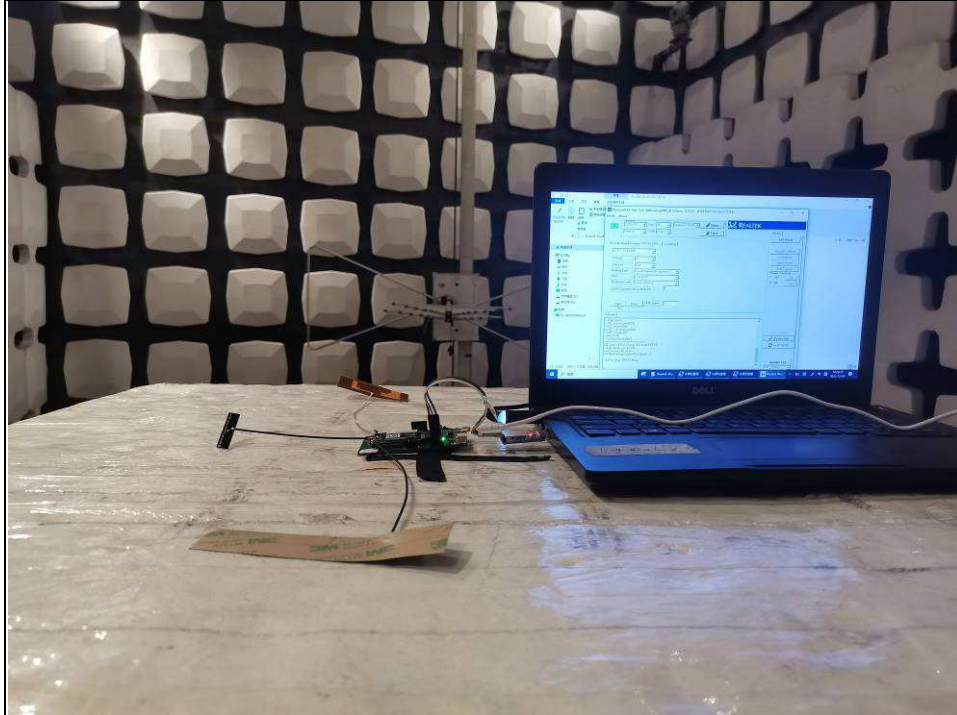

SPURIOUS EMISSION TEST ABOVE 1GHz

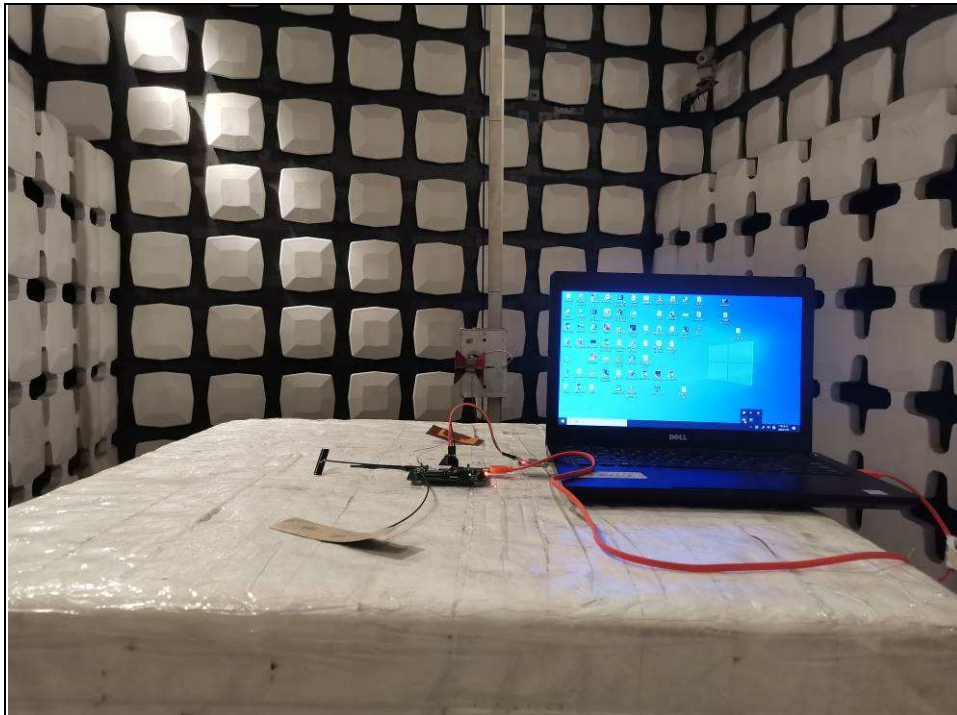

RECEIVING BLOCKING





Test Report No.: RE2312WDG0148-1

5 APPENDIX A – MODIFICATIONS RECORDERS FOR ENGINEERING CHANGES TO THE EUT BY THE LAB

No modifications were made to the EUT by the lab during the test.

--- END ---