

IC TEST REPORT (RSS-130)



Applicant:	Particle Industries, Inc
Address:	126 Post St, 4th floor, San Francisco, CA 94108 USA

Manufacturer or Supplier:	Particle Industries, Inc
Address:	126 Post St, 4th floor, San Francisco, CA 94108 USA
Product:	Tracker One LTE M1
Brand Name:	Particle
Model Name:	ONE402M, ONE404M, ONE402M-NB, ONE404M-NB
IC:	20127-ONE40X
Date of tests:	Aug. 08, 2020 ~ Jan. 21, 2021

The tests have been carried out according to the requirements of the following standard:

- RSS-130 Issue 2, February, 2019**
- RSS-Gen Issue 5, Amendment 1, March 2019**
- ANSI C63.26-2015**

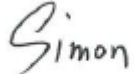
CONCLUSION: The submitted sample was found to COMPLY with the test requirement

Prepared by Simon Wang Engineer / Mobile Department	Approved by Luke Lu Manager / Mobile Department
	
Date: Jan. 21, 2021	Date: Jan. 21, 2021

This report is governed by, and incorporates by reference, CPS Conditions of Service as posted at the date of issuance of this report at <http://www.bureauveritas.com/home/about-us/our-business/cps/about-us/terms-conditions> and is intended for your exclusive use. Any copying or replication of this report to or for any other person or entity, or use of our name or trademark, is permitted only with our prior written permission. This report sets forth our findings solely with respect to the test samples identified herein. The results set forth in this report are not indicative or representative of the quality or characteristics of the lot from which a test sample was taken or any similar or identical product unless specifically and expressly noted. Our report includes all of the tests requested by you and the results thereof based upon the information that you provided to us. Measurement uncertainty is only provided upon request for accredited tests. You have 60 days from date of issuance of this report to notify us of any material error or omission caused by our negligence or if you require measurement uncertainty; provided, however, that such notice shall be in writing and shall specifically address the issue you wish to raise. A failure to raise such issue within the prescribed time shall constitute your unqualified acceptance of the completeness of this report, the tests conducted and the correctness of the report contents.



TABLE OF CONTENTS

RELEASE CONTROL RECORD 4

1 SUMMARY OF TEST RESULTS 5

1.1 MEASUREMENT UNCERTAINTY 6

1.2 TEST SITE AND INSTRUMENTS 7

2 GENERAL INFORMATION..... 8

2.1 GENERAL DESCRIPTION OF EUT 8

2.2 CONFIGURATION OF SYSTEM UNDER TEST 10

2.3 DESCRIPTION OF SUPPORT UNITS11

2.4 DESCRIPTION OF TEST MODES.....11

2.5 GENERAL DESCRIPTION OF APPLIED STANDARDS 13

2.6 TRANSMIT ANTENNA 13

3 TEST TYPES AND RESULTS 14

3.1 OUTPUT POWER MEASUREMENT 14

3.1.1 LIMITS OF OUTPUT POWER MEASUREMENT 14

3.1.2 TEST PROCEDURES 14

3.1.3 TEST SETUP 15

3.1.4 TEST RESULTS 16

3.2 FREQUENCY STABILITY MEASUREMENT 17

3.2.1 LIMITS OF FREQUENCY STABILITY MEASUREMENT 17

3.2.2 TEST PROCEDURE 17

3.2.3 TEST SETUP 17

3.2.4 TEST RESULTS 18

3.3 OCCUPIED BANDWIDTH MEASUREMENT 19

3.3.1 LIMITS OF OCCUPIED BANDWIDTH MEASUREMENT 19

3.3.2 TEST SETUP 19

3.3.3 TEST PROCEDURES 19

3.3.4 TEST RESULTS 20

3.4 PEAK TO AVERAGE RATIO 21

3.4.1 LIMITS OF PEAK TO AVERAGE RATIO MEASUREMENT 21

3.4.2 TEST SETUP 21

3.4.3 TEST PROCEDURES 21

3.4.4 TEST RESULTS 22

3.5 BAND EDGE MEASUREMENT 23

3.5.1 LIMITS OF BAND EDGE MEASUREMENT 23

3.5.2 TEST SETUP 23

3.5.3 TEST PROCEDURES 24

3.5.4 TEST RESULTS 25

3.6 CONDUCTED SPURIOUS EMISSIONS..... 26

3.6.1 LIMITS OF CONDUCTED SPURIOUS EMISSIONS MEASUREMENT 26

ADDITIONAL UNWANTED EMISSIONS LIMITS 26

3.6.2 TEST PROCEDURE 26

3.6.3 TEST SETUP 27

3.6.4 TEST RESULTS 28

3.7 RADIATED EMISSION MEASUREMENT 29

3.7.1 LIMITS OF RADIATED EMISSION MEASUREMENT 29

3.7.2 TEST PROCEDURES 29

3.7.3 DEVIATION FROM TEST STANDARD 29

3.7.4 TEST SETUP 30

3.7.5 TEST RESULTS 32



4	INFORMATION ON THE TESTING LABORATORIES	35
5	APPENDIX A – MODIFICATIONS RECORDERS FOR ENGINEERING CHANGES TO THE EUT BY THE LAB	36



RELEASE CONTROL RECORD

ISSUE NO.	REASON FOR CHANGE	DATE ISSUED
IC200807W004-3	Original release	Sept. 16, 2020
IC200927W002-3	Based on the original report IC200807W004-3 add circuit, change HW version and add two models ONE402M-NB, ONE404M-NB. In this report verify below 1G RSE data, other test data is reused from the original test report	Jan. 21, 2021



1 SUMMARY OF TEST RESULTS

The EUT has been tested according to the following specifications:

APPLIED STANDARD: IC RSS-130, RSS-Gen			
STANDARD SECTION	TEST TYPE AND LIMIT	RESULT	REMARK
RSS-Gen			
6.7	Occupied Bandwidth	N.A	Meet the requirement of limit
6.8	Transmit antenna	Compliance	Meet the requirement of limit
STANDARD SECTION	TEST TYPE AND LIMIT	RESULT	REMARK
RSS-130			
4.5	Frequency Stability AFC Freq. Error vs. Voltage AFC Freq. Error vs. Temperature	N.A	See note
4.6	Maximum Peak Output Power	N.A	See note
4.6	peak-to-average power ratio	N.A	See note
4.7	Band Edge Measurements	N.A	See note
4.7	Conducted Spurious Emissions	N.A	See note
4.7	Radiated Spurious Emissions	Compliance	Meet the requirement of limit

Refer to KDB 971168 D01 Power Meas License Digital Systems v03r01.

Note: In this report only verify and show the below 1G RSE data, other test data is reused from the original test report. More details please refer test report IC200807W004-3.



1.1 MEASUREMENT UNCERTAINTY

Where relevant, the following measurement uncertainty levels have been estimated for tests performed on the EUT as specified in ETSI TR 100 028-1 V1.4.1(2001-12):

MEASUREMENT	UNCERTAINTY
Frequency Stability	±76.97Hz
Radiated emissions & Radiated Power (30MHz~1GMHz)	±4.98dB
Radiated emissions & Radiated Power (1GMHz ~6GMHz)	±4.70dB
Radiated emissions (6GMHz ~18GMHz)	±4.60dB
Radiated emissions (18GMHz ~40GMHz)	±4.12dB
Conducted emissions	±4.01dB
Occupied Channel Bandwidth	±43.58KHz
Conducted Output power	±2.06dB
Band Edge Measurements	±4.70dB
Peak to average ratio	±0.76dB

This uncertainty represents an expanded uncertainty expressed at approximately the 95% confidence level using a coverage factor of k=2.



1.2 TEST SITE AND INSTRUMENTS

Equipment	Manufacturer	Model No.	Serial No.	Last Cal.	Next Cal.
MXE EMI Receiver	KEYSIGHT	N9038A-544	MY54450026	Apr. 27,20	Apr. 26,21
EXA Signal Analyzer	KEYSIGHT	N9010A-526	MY54510322	Feb. 26,20	Feb. 25,21
Bilog Antenna	ETS-LINDGREN	3143B	00161965	Mar. 27,20	Mar. 26,21
Horn Antenna (1GHz-18GHz)	ETS-LINDGREN	3117	00168692	Mar. 27,20	Mar. 26,21
Horn Antenna (18GHz-40GHz)	N/A	QWH-SL-18-40 -K-SG/QMS-00 361	15433	Nov. 24, 20	Nov. 23, 21
Radio Communication Analyzer	ANRITSU	MT8820C	6201465426	Feb. 27,20	Feb. 26,21
Signal Pre-Amplifier	EMSI	EMC 9135	980249	Jun. 02,20	Jun. 01,21
Signal Pre-Amplifier	EMSI	EMC 012645B	980257	Jun. 02,20	Jun. 01,21
Signal Pre-Amplifier	EMSI	EMC 184045B	980259	Apr. 30,20	Apr. 29,21
3m Semi-anechoic Chamber	ETS-LINDGREN	9m*6m*6m	Euroshieldpn- CT0001143-1216	May. 19,20	May. 18,23
Test Software	E3	V 9.160323	N/A	N/A	N/A
Test Software	ADT	ADT_Radiated _V7.6.15.9.2	N/A	N/A	N/A
10dB Attenuator	JFW/USA	50HF-010-SM A	1505	Jun. 03,20	Jun. 02,21
Power Meter	Anritsu	ML2495A	1506002	Feb. 26,20	Feb. 25,21
Power Sensor	Anritsu	MA2411B	1339352	Feb. 26,20	Feb. 25,21
Humid & Temp Programmable Tester	Juyi	ITH-120-45-CP -AR	IAA1504-001	Jun. 02,20	Jun. 01,21
MXG Analog Microvave Signal Generator	KEYSIGHT	N5183A	MY50143024	Mar. 11,20	Mar. 10,21
Power Divider	MCLI/USA	PS2-15	24880	N/A	N/A

- NOTE:**
1. The calibration interval of the above test instruments is 12 months or 36 months and the calibrations are traceable to CEPREI/CHINA, GRGT/CHINA and NIM/CHINA.
 2. The test was performed in 3m Semi-anechoic Chamber and RF Oven Room.
 3. The horn antenna is used only for the measurement of emission frequency above 1GHz if tested.
 4. The IC test Site Registration No. is 21771-1; The Designation No. is CN0007.



2 GENERAL INFORMATION

2.1 GENERAL DESCRIPTION OF EUT

PRODUCT	Tracker One LTE M1	
BRAND NAME	Particle	
MODEL NAME	ONE402M, ONE404M, ONE402M-NB, ONE404M-NB	
POWER SUPPLY	DC 3.7V from Battery or DC 5V from USB Host Unit or DC 12V from Adapter (support unit)	
MODULATION TECHNOLOGY	LTE	QPSK, 16QAM
FREQUENCY RANGE	LTE Band 12 Channel Bandwidth: 1.4MHz	699.7MHz ~ 715.3MHz
	LTE Band 12 Channel Bandwidth: 3MHz	700.5MHz ~ 714.5MHz
	LTE Band 12 Channel Bandwidth: 5MHz	701.5MHz ~ 713.5MHz
	LTE Band 12 Channel Bandwidth: 10MHz	704.0MHz ~ 711.0MHz
	LTE Band 13 Channel Bandwidth: 5MHz	779.5MHz ~ 784.5MHz
	LTE Band 13 Channel Bandwidth: 10MHz	782.0MHz
EMISSION DESIGNATOR	LTE Band 12 Channel Bandwidth: 1.4MHz	QPSK: 1M11G7D
		16QAM: 939KW7D
	LTE Band 12 Channel Bandwidth: 3MHz	QPSK: 1M15G7D
		16QAM: 985KW7D
	LTE Band 12 Channel Bandwidth: 5MHz	QPSK: 1M14G7D
		16QAM: 976KW7D
	LTE Band 12 Channel Bandwidth: 10MHz	QPSK: 1M21G7D
		16QAM: 1M08W7D
	LTE Band 13 Channel Bandwidth: 5MHz	QPSK: 1M15G7D
		16QAM: 977KW7D
	LTE Band 13 Channel Bandwidth: 10MHz	QPSK: 1M18G7D
		16QAM: 1M03W7D



MAX. ERP/EIRP POWER	LTE Band 12 Channel Bandwidth: 1.4MHz	184mW
	LTE Band 12 Channel Bandwidth: 3MHz	184mW
	LTE Band 12 Channel Bandwidth: 5MHz	185mW
	LTE Band 12 Channel Bandwidth: 10MHz	186mW
	LTE Band 13 Channel Bandwidth: 5MHz	185mW
	LTE Band 13 Channel Bandwidth: 10MHz	185mW
ANTENNA TYPE	External Antenna with 1.98dBi gain for LTE B12/LTE B13	
HW VERSION	V1.1	
SW VERSION	V1.5.4	
I/O PORTS	Refer to user's manual	
DATA CABLE	USB cable: non-shielded, detachable,2meter	

NOTE:

- For a more detailed features description, please refer to the manufacturer's specifications or the user's manual.
- The EUT was powered by the following Battery:

BATTERY	
BRAND:	Zhaoneng
MODEL:	113450
MANUFACTURER	Zhaoneng Battery Industrial Co., Ltd
POWER RATING:	3.7V, 2000mAh

- The EUT matched the following USB cable:

USB CABLE	
RAND:	KAWEEI
MODEL:	CBUSB31-AM-CM-2000
SIGNAL LINE:	2.0 METER

- The EUT incorporates a SISO function. Physically, the EUT provides one completed transmitter and one receiver.

MODULATION MODE	TX FUNCTION
LTE	1TX/1RX

- The schematic and PCB of each model is same, and the HW&SW used is the same. The only difference is ONE402M uses eSIM of Kore, ONE404M uses eSIM of Twilio. At the same time, we add two product models on v1.1, ONE402M-NB, ONE404M-NB, please see the table below for the differences of different model.

Product name	e-SIM company	Built-in LiPo battery
ONE402M	Kore	Yes
ONE404M	Twilio	Yes
ONE402M-NB	Kore	No
ONE404M-NB	Twilio	No

- For the test results, the EUT had been tested with all conditions. But only the worst case was shown in test report.



2.2 CONFIGURATION OF SYSTEM UNDER TEST

FOR RADIATION EMISSION TEST

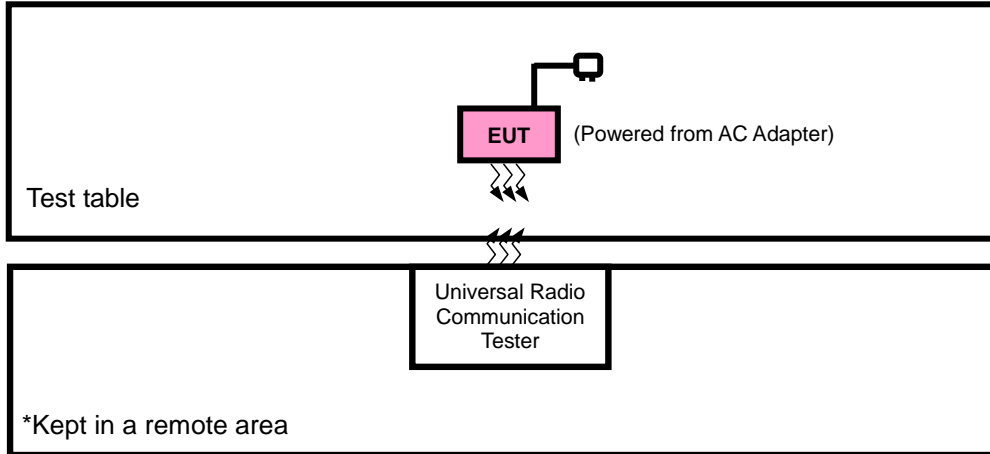

FOR CONDUCTED & E.R.P. TEST

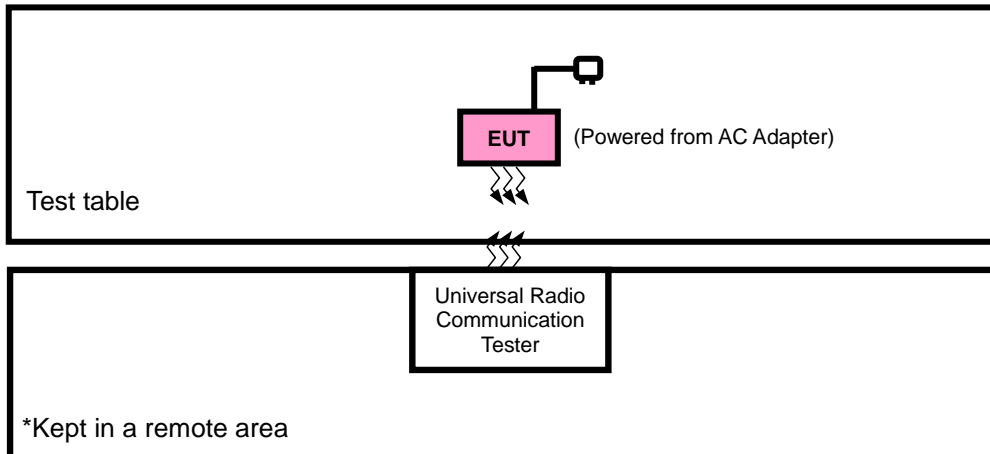



2.3 DESCRIPTION OF SUPPORT UNITS

The EUT has been tested as an independent unit together with other necessary accessories or support units. The following support units or accessories were used to form a representative test configuration during the tests.

NO.	PRODUCT	BRAND	MODEL NO.	SERIAL NO.	FCC ID
1	DC source	LONG WEI	PS-6403D	010934269	N/A

NO.	SIGNAL CABLE DESCRIPTION OF THE ABOVE SUPPORT UNITS
1	DC Line: Unshielded, Detachable 1.0m

NOTE:

1. All power cords of the above support units are non shielded.

2.4 DESCRIPTION OF TEST MODES

Pre-Scan has been conducted to determine the worst-case mode from all possible combinations between available modulations, data rates, XYZ axis and antenna ports. The worst case was found when positioned on Y-plane for ERP and X-axis for radiated emission. Following channel(s) was (were) selected for the final test as listed below:

EUT CONFIGURE MODE	DESCRIPTION
A	EUT + Adapter + USB Cable with LTE link
B	EUT + Battery with LTE link



LTE BAND 12

EUT CONFIGURE MODE	TEST ITEM	AVAILABLE CHANNEL	TESTED CHANNEL	CHANNEL BANDWIDTH	MODULATION	MODE
A	RADIATED EMISSION	23017 to 23173	23095	1.4MHz	QPSK	1 RB / 0 RB Offset
		23025 to 23165	23095	3MHz	QPSK	1 RB / 0 RB Offset
		23035 to 23155	23095	5MHz	QPSK	1 RB / 0 RB Offset
		23060 to 23130	23060, 23095 ,23130	10MHz	QPSK	1 RB / 0 RB Offset

Note: This device was tested under all bandwidths, RB configurations and modulations. The worst case was found in QPSK modulation.

LTE BAND 13

EUT CONFIGURE MODE	TEST ITEM	AVAILABLE CHANNEL	TESTED CHANNEL	CHANNEL BANDWIDTH	MODULATION	MODE
A	RADIATED EMISSION	23205 to 23255	23205, 23230, 23255	5MHz	QPSK	1 RB / 0 RB Offset
		23230	23230	10MHz	QPSK	1 RB / 0 RB Offset

Note: This device was tested under all bandwidths, RB configurations and modulations. The worst case was found in QPSK modulation.

TEST CONDITION:

TEST ITEM	ENVIRONMENTAL CONDITIONS	INPUT POWER	TESTED BY
RADIATED EMISSION	23deg. C, 70%RH	DC 5V from USB Host Unit	Jace Hu



2.5 GENERAL DESCRIPTION OF APPLIED STANDARDS

The EUT is a RF product. According to the specifications of the manufacturer, it must comply with the requirements of the following standards:

Canada RSS-130, Issue 2, February 2019

Canada RSS-Gen, Issue 5, Amendment 1, March 2019

ANSI C63.26 - 2015

NOTE: All test items have been performed and recorded as per the above standards.

2.6 TRANSMIT ANTENNA

The applicant for equipment certification shall provide a list of all antenna types that may be used with the transmitter, where applicable (i.e. for transmitters with detachable antenna), indicating the maximum permissible antenna gain (in dBi) and the required impedance for each antenna. The test report shall demonstrate the compliance of the transmitter with the limit for maximum equivalent isotropically radiated power (e.i.r.p.) specified in the applicable RSS, when the transmitter is equipped with any antenna type, selected from this list.

Antenna Type	External Antenna
Antenna Gain	1.98 dBi
Impedance	50 Ω



3 TEST TYPES AND RESULTS

3.1 OUTPUT POWER MEASUREMENT

3.1.1 LIMITS OF OUTPUT POWER MEASUREMENT

For frequency bands 617-652MHz and 663-698MHz:

The e.r.p. shall not exceed 3 watts for mobile equipment, fixed subscriber equipment and portable equipment.

For frequency bands 698-756MHz and 777-787MHz:

The e.r.p. shall not exceed 30 watts for mobile equipment and outdoor fixed subscriber equipment. The e.r.p. shall not exceed 3 watts for portable equipment and indoor fixed subscriber equipment.

3.1.2 TEST PROCEDURES

ERP MEASUREMENT:

Per KDB 971168 D01 Power Meas License Digital Systems v03r01 or subclause 5.2.5.5 of ANSI C63.26-2015, the relevant equation for determining the ERP or EIRP from the conducted RF output power measured using the guidance provided above is:

$$\text{ERP or EIRP} = P_{\text{Meas}} + G_{\text{T}} - L_{\text{C}}$$

Where:

ERP or EIRP = effective radiated power or equivalent isotropically radiated power, respectively

(expressed in the same units as P_{Meas} , typically dBW or dBm);

P_{Meas} = measured transmitter output power or PSD, in dBm or dBW;

G_{T} = gain of the transmitting antenna, in dBd (ERP) or dBi (EIRP);

L_{C} = signal attenuation in the connecting cable between the transmitter and antenna, in dB.

$$\text{ERP} = \text{EIRP} - 2.15$$

CONDUCTED POWER MEASUREMENT:

- The EUT was set up for the maximum power with LTE link data modulation and link up with simulator.
- Set the EUT to transmit under low, middle and high channel and record the power level shown on simulator.



3.1.3 TEST SETUP

CONDUCTED POWER MEASUREMENT:

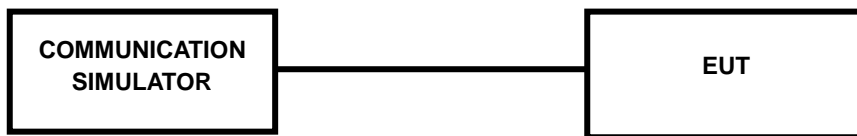



**BUREAU
VERITAS**

Test Report No.: IC200927W002-3

3.1.4 TEST RESULTS

N/A



3.2 FREQUENCY STABILITY MEASUREMENT

3.2.1 LIMITS OF FREQUENCY STABILITY MEASUREMENT

The frequency stability shall be sufficient to ensure that the fundamental emissions stay within the authorized bands of operation.

3.2.2 TEST PROCEDURE

- Device is placed at the oven room. The oven room could control the temperatures and humidity. Power warm up is at least 15 min and power applied should perform before recording frequency error.
- EUT is connected the external power supply to control the DC input power. The test voltage range is from minimum to maximum working voltage. Each step shall be record the frequency error rate.
- The temperature range step is 10 degrees in this test items. All temperature levels shall be hold the $\pm 0.5^{\circ}\text{C}$ during the measurement testing. The each temperature step shall be at least 0.5 hours, consider the EUT could be test under the stability condition.

NOTE: The frequency error was recorded frequency error from the communication simulator.

3.2.3 TEST SETUP

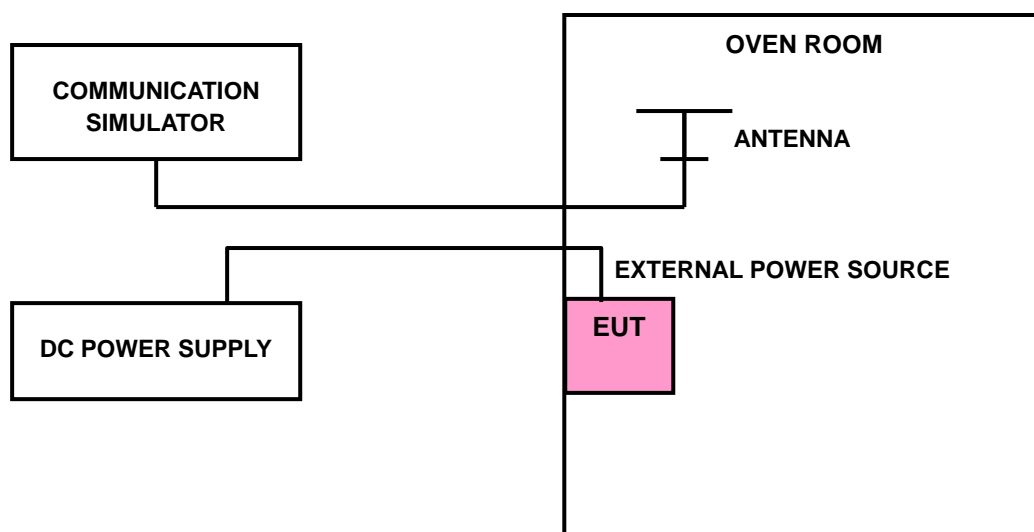



Test Report No.: IC200927W002-3

3.2.4 TEST RESULTS

N/A



3.3 OCCUPIED BANDWIDTH MEASUREMENT

3.3.1 LIMITS OF OCCUPIED BANDWIDTH MEASUREMENT

The width of a frequency band such that, below the lower and above the upper frequency limits, the mean powers emitted are each equal to a specified percentage 0.5 %of the total mean power of a given emission.

3.3.2 TEST SETUP

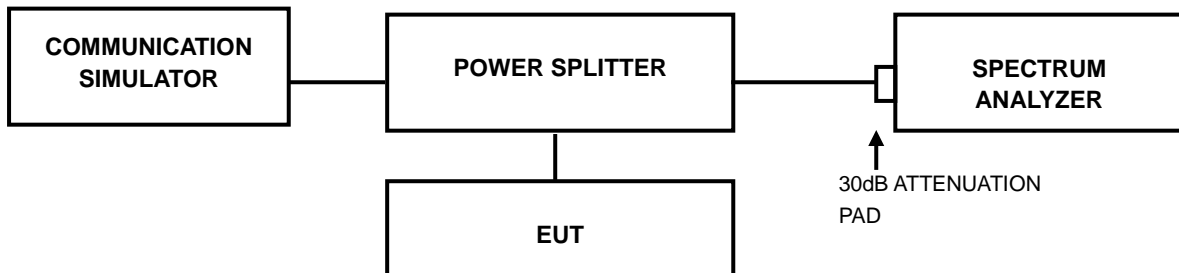

3.3.3 TEST PROCEDURES

- a. The conducted occupied bandwidth used the power splitter via EUT RF power connector between simulation base station and spectrum analyzer.
- b. Use OBW measurement function of Spectrum analyzer to measure 99 % occupied bandwidth.



**BUREAU
VERITAS**

Test Report No.: IC200927W002-3

3.3.4 TEST RESULTS

N/A



3.4 PEAK TO AVERAGE RATIO

3.4.1 LIMITS OF PEAK TO AVERAGE RATIO MEASUREMENT

In measuring transmissions in this band using an average power technique, the peak to-average ratio (PAR) of the transmission may not exceed 13 dB

3.4.2 TEST SETUP

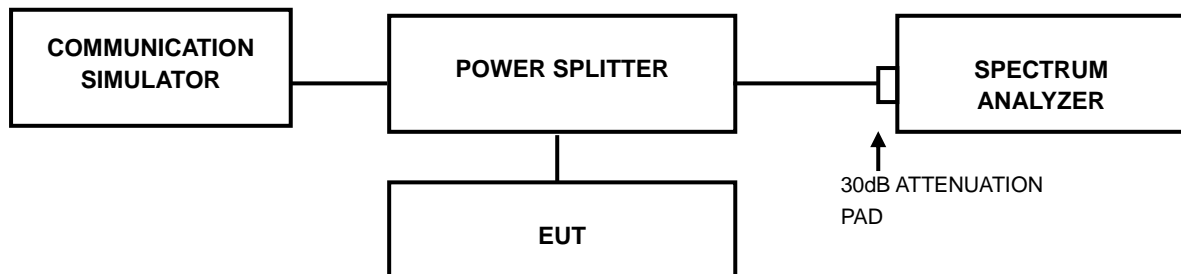

3.4.3 TEST PROCEDURES

1. Set resolution/measurement bandwidth \geq signal's occupied bandwidth;
2. Set the number of counts to a value that stabilizes the measured CCDF curve;
3. Record the maximum PAPR level associated with a probability of 0.1%.



Test Report No.: IC200927W002-3

3.4.4 TEST RESULTS

N/A



3.5 BAND EDGE MEASUREMENT

3.5.1 LIMITS OF BAND EDGE MEASUREMENT

The power of any emission outside a licensee's frequency band(s) of operation shall be attenuated below the transmitter power (P) within the licensed band(s) of operation, measured in watts, by at least $43 + 10 \log (P)$ dB. Compliance with this provision is based on the use of measurement instrumentation employing a resolution bandwidth of 100 kilohertz or greater.

However, in the 100 kilohertz bands immediately outside and adjacent to a licensee's frequency block, a resolution bandwidth of at least 30 kHz may be employed.

3.5.2 TEST SETUP

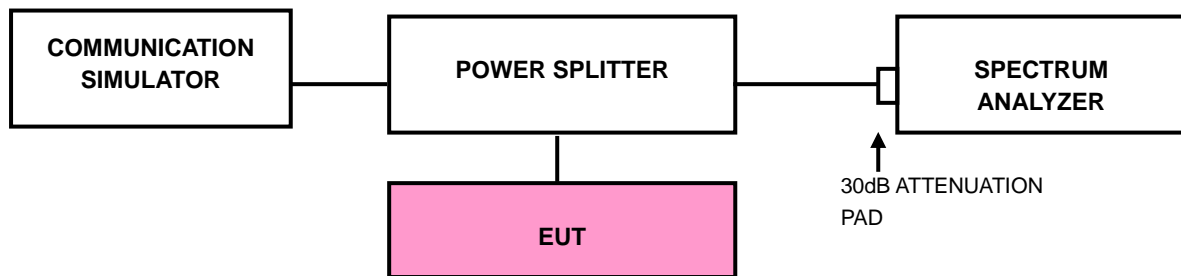



3.5.3 TEST PROCEDURES

- a. The EUT was set up for the maximum peak power with LTE link data modulation. The power was measured with R&S Spectrum Analyzer. All measurements were done at 2 channels (low and high operational frequency range.).
- b. The band edge measurement used the power splitter via EUT RF power connector between simulation base station and spectrum analyzer.
- c. The center frequency of spectrum is the band edge frequency and span is 1~5 MHz. RBW of the spectrum is 20kHz and VBW of the spectrum is 100 kHz. (LTE bandwidth 1.4MHz)
- d. The center frequency of spectrum is the band edge frequency and span is 1~5 MHz. RBW of the spectrum is 30kHz and VBW of the spectrum is 100kHz. (LTE bandwidth 3MHz)
- e. The center frequency of spectrum is the band edge frequency and span is 1~5 MHz. RBW of the spectrum is 50kHz and VBW of the spectrum is 200kHz. (LTE bandwidth 5MHz)
- f. The center frequency of spectrum is the band edge frequency and span is 1~5 MHz. RBW of the spectrum is 100kHz and VBW of the spectrum is 300kHz. (LTE bandwidth 10MHz)
- g. Record the max trace plot into the test report.



**BUREAU
VERITAS**

Test Report No.: IC200927W002-3

3.5.4 TEST RESULTS

N/A



3.6 CONDUCTED SPURIOUS EMISSIONS

3.6.1 LIMITS OF CONDUCTED SPURIOUS EMISSIONS MEASUREMENT

The power of any emission outside a licensee's frequency block shall be attenuated below the transmitter power (P) by at least $43 + 10 \log_{10}(P)$ dB. The limit of emission equal to -13dBm

Additional unwanted emissions limits

In addition to the limit outlined in [section 4.7.1](#) above, equipment operating in the frequency bands 746-756 MHz and 777-787 MHz shall also comply with the following restrictions:

- a. the power of any unwanted emissions in any 6.25 kHz bandwidth for all frequencies between 763-775 MHz and 793-806 MHz shall be attenuated below the transmitter power, P (dBW), by at least:
 - i. $76 + 10 \log_{10} p$ (watts), dB, for base and fixed equipment and
 - ii. $65 + 10 \log_{10} p$ (watts), dB, for mobile and portable equipment
- b. the e.i.r.p. in the band 1559-1610 MHz shall not exceed -70 dBW/MHz for wideband signal and -80 dBW for discrete emission with bandwidth less than 700 Hz.

3.6.2 TEST PROCEDURE

- a. The EUT makes a phone call to the communication simulator. All measurements were done at middle operational frequency range.
- b. Measuring frequency range is from 30 MHz to 8GHz for LTE Band 12&13. 10dB attenuation pad is connected with spectrum. RBW=1MHz and VBW=3MHz are used for conducted emission measurement.



3.6.3 TEST SETUP

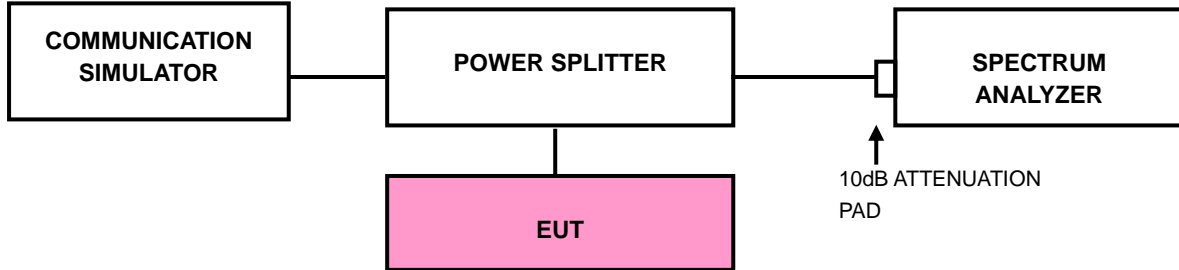



Test Report No.: IC200927W002-3

3.6.4 TEST RESULTS

N/A



3.7 RADIATED EMISSION MEASUREMENT

3.7.1 LIMITS OF RADIATED EMISSION MEASUREMENT

The power of any emission outside a licensee's frequency block shall be attenuated below the transmitter power (P) by at least $43 + 10 \log_{10}(P)$ dB. The limit of emission equal to -13dBm

3.7.2 TEST PROCEDURES

- a. Substitution method is used for E.I.R.P measurement. In the semi-anechoic chamber, EUT placed on the 0.8m/1.5m height of Turn Table, rotated the table around 360 degrees to search the maximum radiation power and receiver antenna shall be rotated vertical and horizontal polarization and moved height from 1m to 4m to find the maximum polar radiated power. The "Read Value" is the spectrum reading the maximum power value.
- b. The substitution horn antenna is substituted for EUT at the same position and signals generator export the CW signal to the substitution antenna via a TX cable. Rotated the Turn Table and moved receiving antenna to find the maximum radiation power. Adjust output power level of S.G to get a Value of spectrum reading equal to "Read Value" of step a. Record the power level of S.G
- c. $\text{EIRP} = \text{Output power level of S.G} - \text{TX cable loss} + \text{Antenna gain of substitution horn.}$
- d. E.R.P power can be calculated form E.I.R.P power by subtracting the gain of dipole, $\text{E.R.P power} = \text{E.I.P.R power} - 2.15\text{dBi.}$

NOTE: The resolution bandwidth of spectrum analyzer is 1 MHz and the video bandwidth is 3 MHz.

3.7.3 DEVIATION FROM TEST STANDARD

No deviation



3.7.4 TEST SETUP

< Frequency Range below 30MHz >

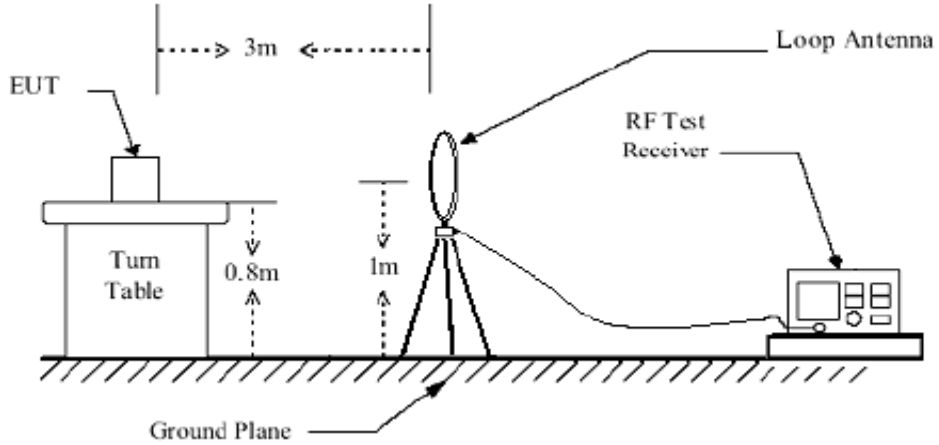

< Frequency Range 30MHz~1GHz >

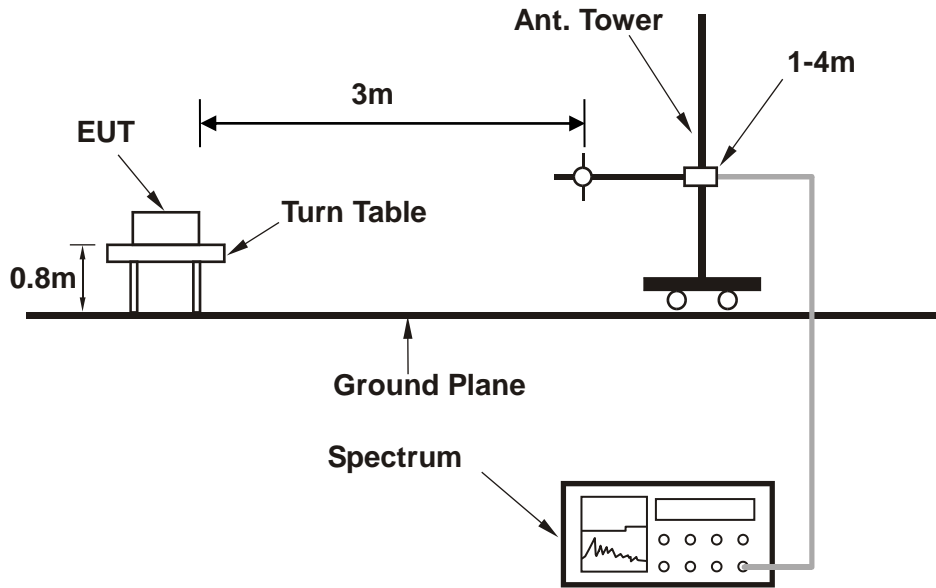



< Frequency Range above 1GHz >

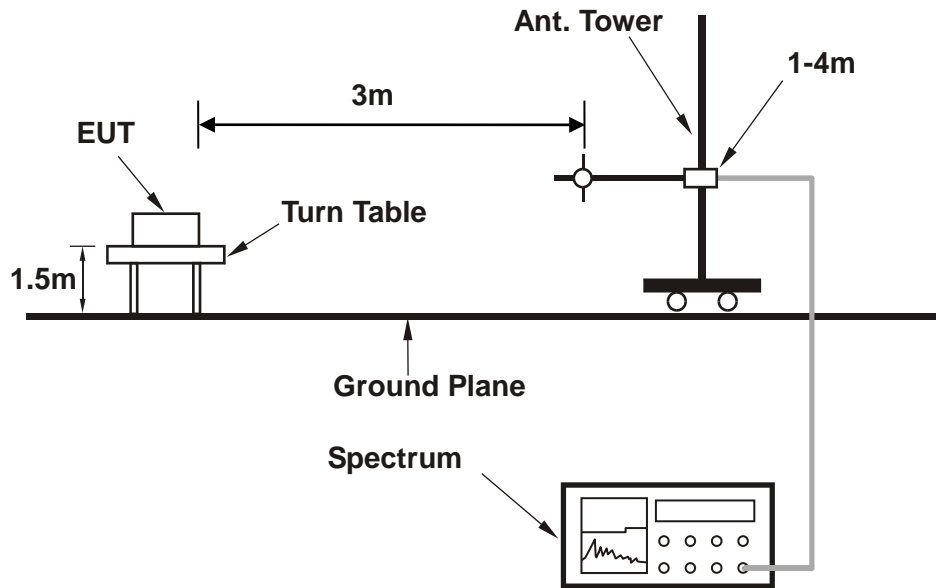

For the actual test configuration, please refer to the attached file (Test Setup Photo).



3.7.5 TEST RESULTS

BELOW 1GHz WORST-CASE DATA

30 MHz – 1GHz data:

LTE BAND 13

CHANNEL BANDWIDTH: 5MHz / QPSK

MODE	TX channel 23230	FREQUENCY RANGE	Below 1000MHz
ENVIRONMENTAL CONDITIONS	23deg. C, 70%RH	INPUT POWER	DC 5V from USB Host Unit
TESTED BY	Jace Hu		
ANTENNA POLARITY & TEST DISTANCE: HORIZONTAL AT 3 M			

	Freq	Level	Read Level	Limit Line	Over Limit	Factor	Remark	Pol/Phase	
	MHz	dBm/m	dBm	dBm/m	dB	dB/m			
1	PP	31.940	-43.57	-60.24	-13.00	-30.57	16.67	Peak	Horizontal
2		63.340	-59.22	-50.32	-13.00	-46.22	-8.90	Peak	Horizontal
3		122.650	-52.82	-37.23	-13.00	-39.82	-15.59	Peak	Horizontal
4		146.720	-54.85	-35.69	-13.00	-41.85	-19.16	Peak	Horizontal
5		189.640	-59.87	-42.36	-13.00	-46.87	-17.51	Peak	Horizontal
6		389.230	-54.08	-43.26	-13.00	-41.08	-10.82	Peak	Horizontal

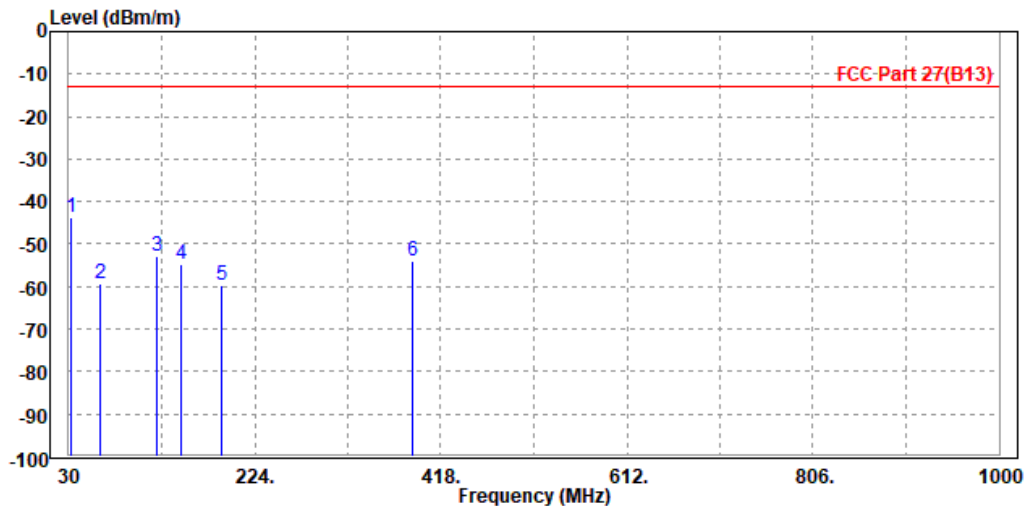



MODE	TX channel 23230	FREQUENCY RANGE	Below 1000MHz
ENVIRONMENTAL CONDITIONS	23deg. C, 70%RH	INPUT POWER	DC 5V from USB Host Unit
TESTED BY	Jace Hu		
ANTENNA POLARITY & TEST DISTANCE: VERTICAL AT 3 M			

	Freq	Level	Read Level	Limit Line	Over Limit	Factor	Remark	Pol/Phase
	MHz	dBm/m	dBm	dBm/m	dB	dB/m		
1 PP	31.940	-46.88	-49.63	-13.00	-33.88	2.75	Peak	Vertical
2	68.590	-57.49	-42.36	-13.00	-44.49	-15.13	Peak	Vertical
3	112.320	-47.95	-35.65	-13.00	-34.95	-12.30	Peak	Vertical
4	147.310	-57.73	-41.75	-13.00	-44.73	-15.98	Peak	Vertical
5	230.850	-54.44	-43.26	-13.00	-41.44	-11.18	Peak	Vertical
6	390.420	-57.27	-46.30	-13.00	-44.27	-10.97	Peak	Vertical

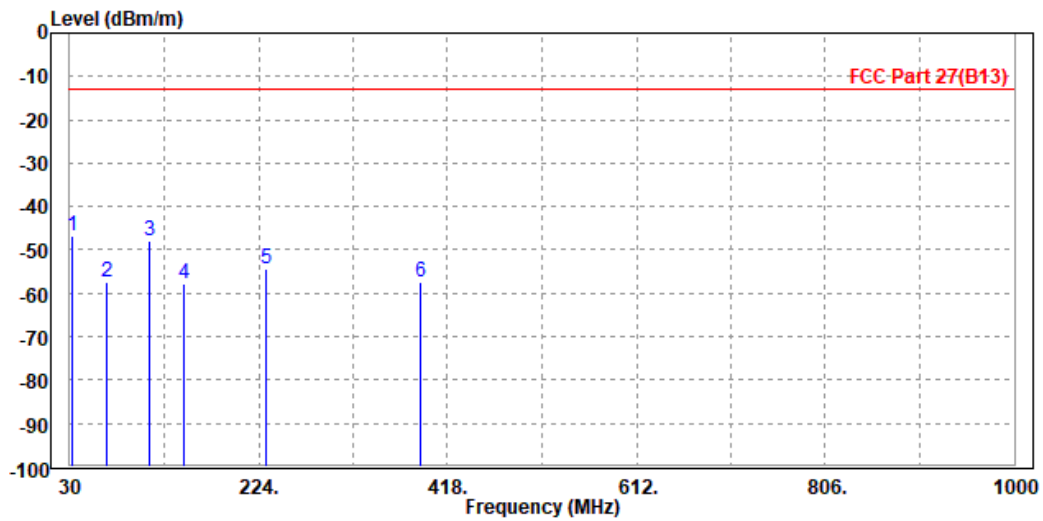



**BUREAU
VERITAS**

Test Report No.: IC200927W002-3

ABOVE 1GHz

Note: For higher frequency, the emission is too low to be detected.

N/A



4 INFORMATION ON THE TESTING LABORATORIES

We, BV 7Layers Communications Technology (Shenzhen) Co. Ltd, were founded in 2015 to provide our best service in EMC, Radio, and Telecom. Our laboratories are accredited and approved according to ISO/IEC 17025.

If you have any comments, please feel free to contact us at the following:

Shenzhen EMC/RF Lab:

Tel: +86 755 8869 6566

Fax: +86 755 8869 6577

Email: customerservice.dg@cn.bureauveritas.com

Web Site: www.adt.com.tw

The address and road map of all our labs can be found in our web site also.



5 APPENDIX A – MODIFICATIONS RECORDERS FOR ENGINEERING CHANGES TO THE EUT BY THE LAB

No modifications were made to the EUT by the lab during the test.

---END---