



Test Report No.: RE2209WDG0276-5



# TEST REPORT



Applicant	Particle Industries, Inc
Address	325 9th Street, San Francisco, CA 94103 United States

Manufacturer or Supplier	Particle Industries, Inc
Address	325 9th Street, San Francisco, CA 94103 United States
Product	Photon 2
Brand Name	Particle
Model	PHN2
Additional Model & Model Difference	N/A
Date of tests	Feb. 21, 2021 ~ Apr. 06, 2022

The submitted sample of the above equipment has been tested according to the requirements of the following standard:

- EN 301 893 V2.1.1 (2017-05)
- Dynamic Frequency Selection (Clause 4.2.6)

**CONCLUSION: The submitted sample was found to COMPLY with the test requirement**

Tested by Lucas Chen Project Engineer / EMC Department	Approved by Glyn He Assistant Manager / EMC Department
	
	Date: Mar. 20, 2023

This report is governed by, and incorporates by reference, the Conditions of Testing as posted at the date of issuance of this report at <http://www.bureauveritas.com/home/about-us/our-business/cps/about-us/terms-conditions/> and is intended for your exclusive use. Any copying or replication of this report to or for any other person or entity, or use of our name or trademark, is permitted only with our prior written permission. This report sets forth our findings solely with respect to the test samples identified herein. The results set forth in this report are not indicative or representative of the quality or characteristics of the lot from which a test sample was taken or any similar or identical product unless specifically and expressly noted. Our report includes all of the tests requested by you and the results thereof based upon the information that you provided to us. Measurement uncertainty is only provided upon request for accredited tests. Statements of conformity are based on simple acceptance criteria without taking measurement uncertainty into account, unless otherwise requested in writing. You have 60 days from date of issuance of this report to notify us of any material error or omission caused by our negligence or if you require measurement uncertainty; provided, however, that such notice shall be in writing and shall specifically address the issue you wish to raise. A failure to raise such issue within the prescribed time shall constitute your unqualified acceptance of the completeness of this report, the tests conducted and the correctness of the report contents.



## TABLE OF CONTENTS

<b>RELEASE CONTROL RECORD .....</b>	<b>3</b>
<b>1. GENERAL DESCRIPTION OF EUT .....</b>	<b>4</b>
<b>2. DYNAMIC FREQUENCY SELECTION .....</b>	<b>6</b>
2.1 TEST LIMITS AND RADAR SIGNAL PARAMETERS .....	7
2.2 EUT INFORMATION .....	10
2.3 TEST INSTRUMENTS .....	11
2.4 DESCRIPTION OF SUPPORT UNITS .....	11
2.5 TEST PROCEDURE .....	12
2.6 DEVIATION FROM TEST STANDARD .....	12
2.7 TEST SETUP CONFIGURATION .....	13
2.8 LIST OF MEASUREMENTS .....	13
2.9 TEST RESULT .....	14
2.9.1 INTERFERENCE THRESHOLD VALUES .....	14
2.10 CHANNEL SHUTDOWN .....	15
<b>3. PHOTOGRAPHS OF THE TEST CONFIGURATION .....</b>	<b>17</b>
<b>4. APPENDIX A – MODIFICATIONS RECORDERS FOR ENGINEERING CHANGES TO THE EUT     BY THE LAB.....</b>	<b>18</b>



Test Report No.: RE2209WDG0276-5

## RELEASE CONTROL RECORD

ISSUE NO.	REASON FOR CHANGE	DATE ISSUED
RE2202WDG0092-5	Original release	May 19, 2022
RE2209WDG0276-5	Based on the original report RF2202WDG0092-5, changed the applicant/manufacture address, product name, model number and added the debugging base, but it doesn't need to be retested after engineer evaluated	Mar. 20, 2023

## 1. GENERAL DESCRIPTION OF EUT

<b>PRODUCT</b>	Photon 2
<b>MODEL NO.</b>	PHN2
<b>ADDITIONAL MODELS</b>	N/A
<b>NOMINAL VOLTAGE</b>	5.0Vdc (Adapter) 3.7Vdc (Li-ion, Battery)
<b>MODULATION TECHNOLOGY</b>	OFDM
<b>MODULATION TYPE</b>	256QAM, 64QAM, 16QAM, QPSK, BPSK for OFDM
<b>TRANSMISSION RATE</b>	802.11a: 54.0/ 48.0/ 36.0/ 24.0/ 18.0/ 12.0/ 9.0/ 6.0Mbps 802.11n: up to 150.0Mbps 802.11ac : up to 200.0Mbps
<b>OPERATING FREQUENCY</b>	5260MHz ~ 5320MHz, 5500MHz ~ 5700MHz
<b>EIRP POWER</b>	21.23 dBm (Measured Max.)
<b>ANTENNA TYPE</b>	5260 ~ 5320MHz: PCB antenna with 1.60dBi gain External PCB Antenna with -0.08dBi gain 5500 ~ 5700MHz: PCB antenna with 1.74dBi gain External PCB Antenna with 0.87dBi gain
<b>I/O PORTS</b>	Refer to user's manual
<b>CABLE SUPPLIED</b>	N/A

### NOTES:

- For a more detailed features description, please refer to the manufacturer's specifications or the user's manual.
- For the test results, the EUT had been tested with all conditions, but only the worst case was shown in test report.
- Please refer to the EUT photo document (Reference No.: 2209WDG0276) for detailed product photo.
- The Photon 2 uses two antennas, but couldn't transmit simultaneously, only the antenna type and gain are different. EIRP, PSD and radiation spurious emission have been evaluated for both antennas respectively. EIRP data and PSD data for both antennas are shown in the report, but only the worst antenna data (PCB antenna) is shown in the test report for the radiation spurious emission test.



5. The EUT provides completed transmitters and receivers, the EUT uses only one antenna at any time.

<b>MODULATION MODE</b>	<b>TX FUNCTION</b>
802.11a	1TX/1RX
802.11n (HT20) 802.11ac (VHT20)	1TX/1RX
802.11n (HT40) 802.11ac (VHT40)	1TX/1RX

\* The modulation and bandwidth are similar for 802.11n mode for HT20 / HT40 and 802.11ac mode for VHT20 / VHT40, therefore investigated worst case for final test were chosen 802.11n (HT20/HT40) and record in the report.

## 2. DYNAMIC FREQUENCY SELECTION

The manufacturer shall state whether the UUT is capable of operating as a Master and/or a Slave. If the UUT is capable of operating in more than one operating mode then each operating mode shall be tested separately. See tables A for the applicability of DFS requirements for each of the operational modes.

### Applicability of DFS requirements

Requirement	Operational Mode		
	Master	Slave (without radar detection)	Slave (with radar detection)
Channel Availability Check	✓	Not required	✓ (see note 2)
Off-Channel CAC (see note 1)	✓	Not required	✓ (see note 2)
In-Service Monitoring	✓	Not required	✓
Channel Shutdown	✓	✓	✓
Non-Occupancy Period	✓	Not required	✓
Uniform Spreading	✓	Not required	Not required

NOTE 1: Where implemented by the manufacturer.  
 NOTE 2: A slave with radar detection is not required to perform a CAC or Off-Channel CAC at initial use of the channel but only after the slave has detected a radar signal on the Operating Channel by In-Service Monitoring.

The radar detection requirements specified in EN 301 893 clauses 4.2.6.2.2 to 4.2.6.2.4 assume that the centre frequencies of the radar signals fall within the central 80 % of the Occupied Channel Bandwidth of the RLAN.

## 2.1 TEST LIMITS AND RADAR SIGNAL PARAMETERS

### DFS requirement values

Parameter	Value
Channel Availability Check Time	60 s (see note 1)
Minimum Off-Channel CAC Time	6 minutes (see note 2)
Maximum Off-Channel CAC Time	4 hours (see note 2)
Channel Move Time	10 s
Channel Closing Transmission Time	1 s
Non-Occupancy Period	30 minutes

NOTE 1: For channels whose nominal bandwidth falls completely or partly within the band 5 600 MHz to 5 650 MHz, the Channel Availability Check Time shall be 10 minutes.

NOTE 2: For channels whose nominal bandwidth falls completely or partly within the band 5 600 MHz to 5 650 MHz, the Maximum Off-Channel CAC Time shall be within the range 1 to 24 hours.

### Interference threshold values

EIRP Spectral Density dBm/MHz	Value (see notes 1 and 2)
10	-62 dBm

NOTE 1: This is the level at the input of the receiver of a RLAN device with a maximum EIRP density of 10 dBm/MHz and assuming a 0 dBi receive antenna. For devices employing different EIRP spectral density and/or a different receive antenna gain G (dBi) the DFS threshold level at the receiver input follows the following relationship:  

$$\text{DFS Detection Threshold (dBm)} = -62 + 10 \cdot \text{EIRP Spectral Density (dBm/MHz)} + G \text{ (dBi)}$$
 however the DFS threshold level shall not be lower than -64 dBm assuming a 0 dBi receive antenna gain.

NOTE 2: Slave devices with a maximum EIRP of less than 23 dBm do not have to implement radar detection.

### Parameters of the reference DFS test signal

Pulse width W [μs]	Pulse repetition frequency PRF [pps]	Pulses per burst [PPB]
1	700	18

### Parameters of radar test signals

Radar Test Signal # (see notes 1 to 3)	Pulse width W [μs]		Pulse Repetition Frequency (pps)		Number of different PRFs	Pulses per Burst for each PRF(PPB) (see notes 5)
	Min	Max	Min	Max		
1	0.5	5	200	1000	1	10 (see note 6)
2	0.5	15	200	1600	1	15 (see note 6)
3	0.5	15	2300	4000	1	25
4	20	30	2000	4000	1	20
5	0.5	2	300	400	2/3	10 (see note 6)
6	0.5	2	400	1200	2/3	15 (see note 6)

NOTE 1: Radar test signals 1 to 4 are constant PRF based signals. See figure D.1. These radar test signals are intended to simulate also radars using a packet based Staggered PRF. See figure D.2.

NOTE 2: Radar test signal 4 is a modulated radar test signal. The modulation to be used is a chirp modulation with a  $\pm 2,5$  MHz frequency deviation which is described below.

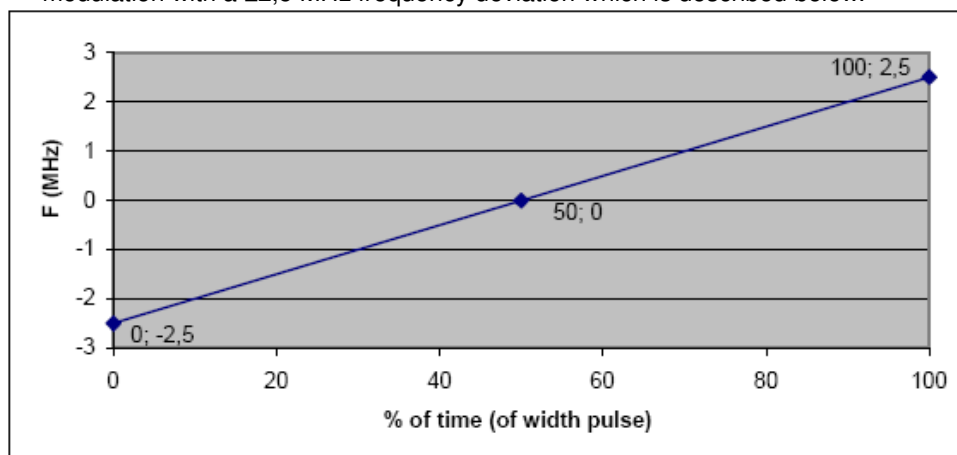

NOTE 3: Radar test signals 5 and 6 are single pulse based Staggered PRF radar test signals using 2 or 3 different PRF values. For radar test signal 5, the difference between the PRF values chosen shall be between 20 pps and 50 pps. For radar test signal 6, the difference between the PRF values chosen shall be between 80 pps and 400 pps. See figure D.3

NOTE 4: Apart for the Off-Channel CAC testing, the radar test signals above shall only contain a single burst of pulses. See figures D.1, D.3 and D.4. For the Off-Channel CAC testing, repetitive bursts shall be used for the total duration of the test. See figures D.2 and D.5. See also clause 4.7.2.2. , 5.3.8.2.1.3.1 and 5.3.8.2.1.3.2.

NOTE 5: The total number of pulses in a burst is equal to the number of pulses for a single PRF multiplied by the number of different PRFs used.

NOTE 6: For the CAC and Off-Channel CAC requirements, the minimum number of pulses (for each PRF) for any of the radar test signals to be detected in the band 5 600 MHz to 5 650 MHz shall be 18.



**Detection probability**

Parameter	Detection Probability (Pd)	
	Channels whose nominal bandwidth falls partly or completely within the 5600 MHz to 5650 MHz band	Other channels
CAC, Off-Channel CAC	99,99 %	60 %
In-Service Monitoring	60 %	60 %
<p>NOTE: Pd gives the probability of detection per simulated radar burst and represents a minimum level of detection performance under defined conditions. Therefore Pd does not represent the overall detection probability for any particular radar under real life conditions.</p>		

## 2.2 EUT INFORMATION

### OPERATING FREQUENCY BANDS AND MODE OF EUT

Operational Mode	Operating Frequency Range	
	5250~5350MHz	5470~5725MHz
Slave without radar detection	✓	✓

### EUT SOFTWARE AND FIRMWARE VERSION

Platform	No.	Product	Model Name	Software/Firmware Version
--	1	Photon 2	PHN2	v1.0/ v1.0

### DESCRIPTION OF AVAILABLE ANTENNAS TO THE EUT

ANT.	BRAND	MODEL	CONNECTOR TYPE	ANT TYPE	FREQUENCY RANGE (MHZ TO MHZ)	NET GAIN(dBi)	CABLE LOSS(dBi)
1	N/A	N/A	N/A	PCB	5250 - 5350	1.60	0
					5470 - 5725	1.74	0
2	N/A	N/A	i-pex	External PCB	5250 - 5350	-0.08	0
					5470 - 5725	0.87	0

## 2.3 TEST INSTRUMENTS

DESCRIPTION & MANUFACTURER	MODEL NO.	BRAND	CALIBRATED UNTIL
Spectrum Analyzer	N9020A	MY55400499	Mar. 20, 23
R&S Spectrum	FSV7	R&S	Nov 24, 22
MXG-B RF Vector Signal Generator	N5182B	MY56200288	Jan. 01, 23
Signal generator	8645A	Agilent	Aug.31, 22

## 2.4 DESCRIPTION OF SUPPORT UNITS

### Support Unit information.

NO.	PRODUCT	BRAND	MODEL NO.	SOFTWARE/FIRMWARE VERSION
1	wireless router	LINKSYS	WRT-3200ACM	1.0.0.174361

**NOTE:** This device was functioned as a Master Slave device during the DFS test.

## 2.5 TEST PROCEDURE

The measured channel is 5300MHz and 5500MHz in 20MHz Bandwidth and 5270MHz and 5510MHz in 40MHz Bandwidth. The radar signal was the same as transmitted channels, and injected into the antenna port of AP (master) with radar signal, measured the channel shutdown. The slave transmitted the test data to master, the transmitted duty cycle is 40.79%.

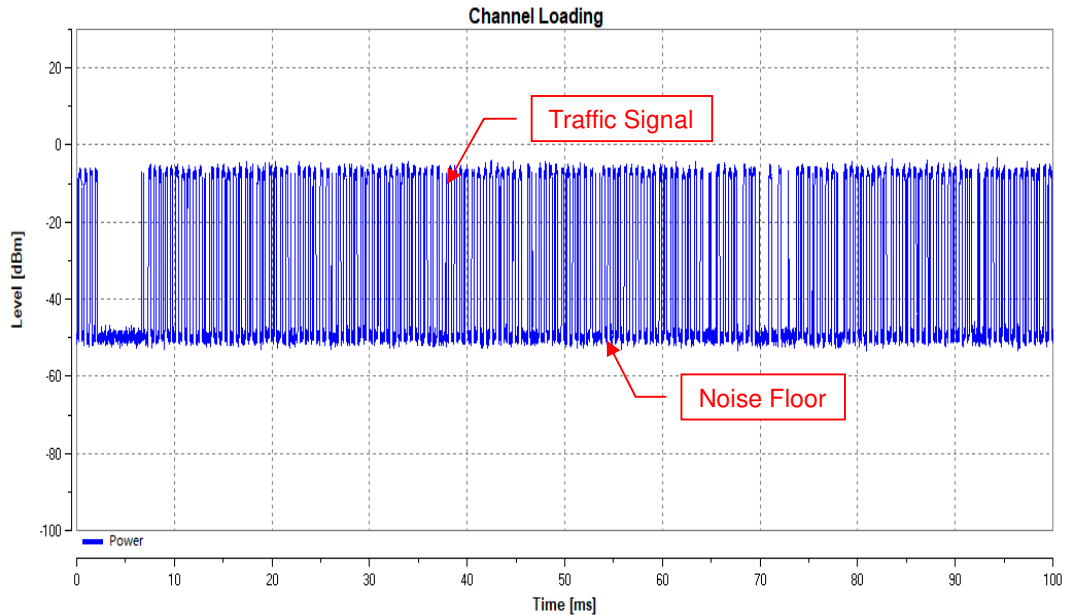

Note: Traffic signal: from slave transmit to master.

## 2.6 DEVIATION FROM TEST STANDARD

No deviation.

## 2.7 TEST SETUP CONFIGURATION

Conducted setup configuration of DFS Measurement System

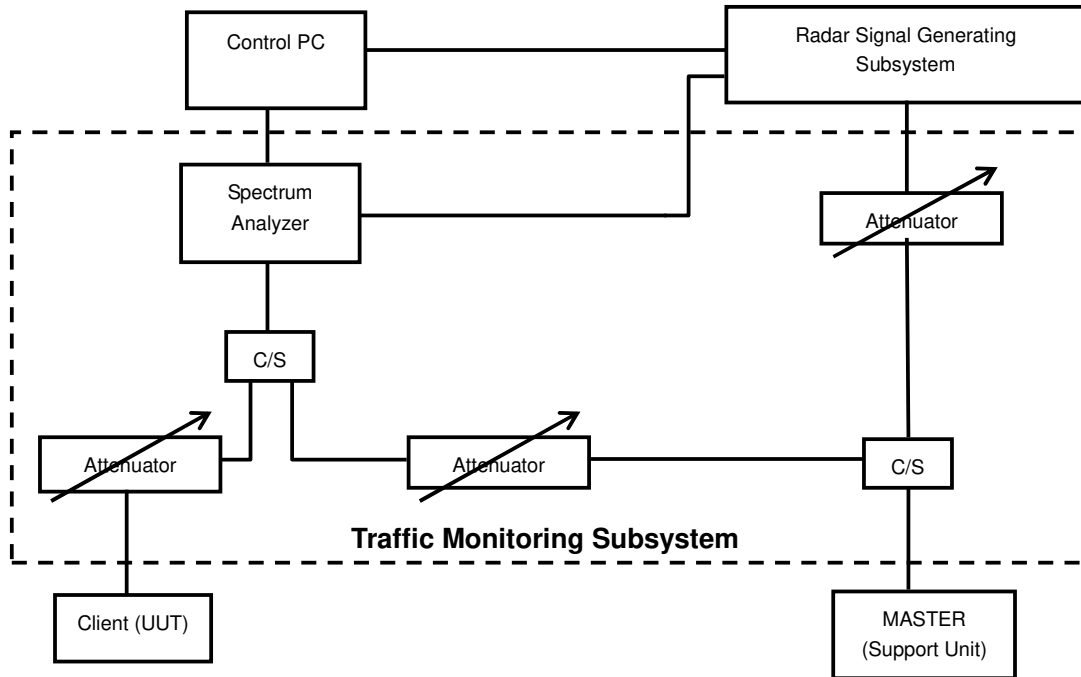

The UUT is a RLAN device operating in slave mode, without Radar Interference Detection function. The radar test signals are injected into the master device.

## 2.8 LIST OF MEASUREMENTS

The EUT is capable of operating as a slave (without radar detection).

Clause	Test Parameter	Remarks	Pass/Fail
4.7.2.1	Channel Availability Check Time	Not Applicable	N/A
4.7.2.2	Off-Channel CAC	Not implemented	N/A
4.7.2.3	In-Service Monitoring	Not Applicable	N/A
4.7.2.4	Channel Shutdown	Applicable	Pass
4.7.2.5	Non- Occupancy Period	Not Applicable	N/A
4.7.2.6	Uniform Spreading	Not Applicable	N/A

## 2.9 TEST RESULT

### 2.9.1 INTERFERENCE THRESHOLD VALUES

The AP Maximum EIRP Spectral Density is 11.22dBm/MHz and antenna gain is 3dBi.  
 DFS Detection Threshold =  $-62 + 10 - \text{EIRP Spectral Density (11.22dBm/MHz)} + G$   
 (3dBi) =  $-60.22\text{dBm}$

The radar burst signal level to the AP connector is  $-60.51\text{dBm}$

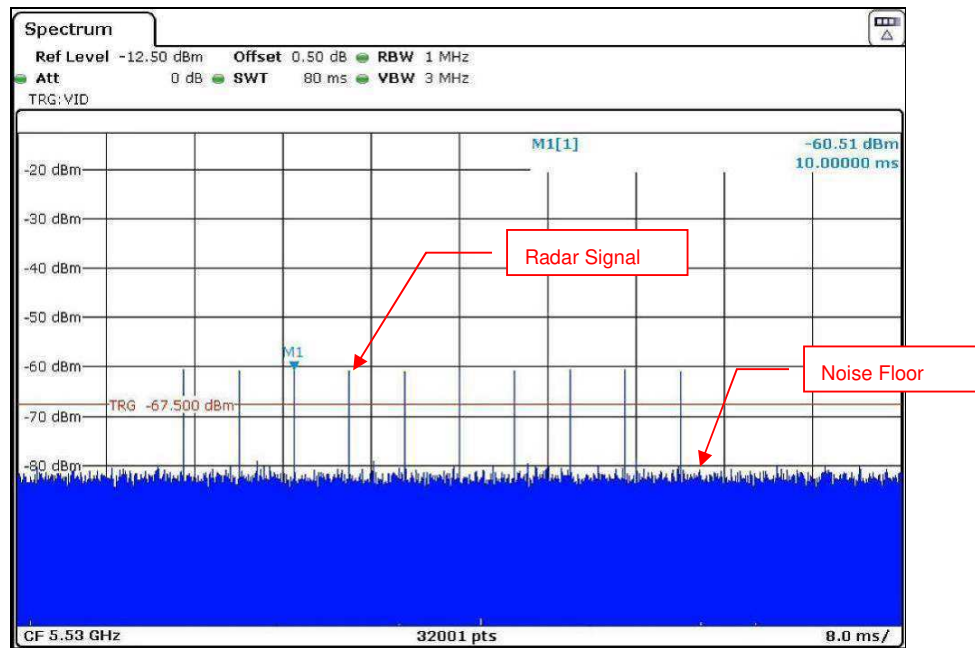

Reference DFS test signal

## 2.10 CHANNEL SHUTDOWN

802.11a

CH60

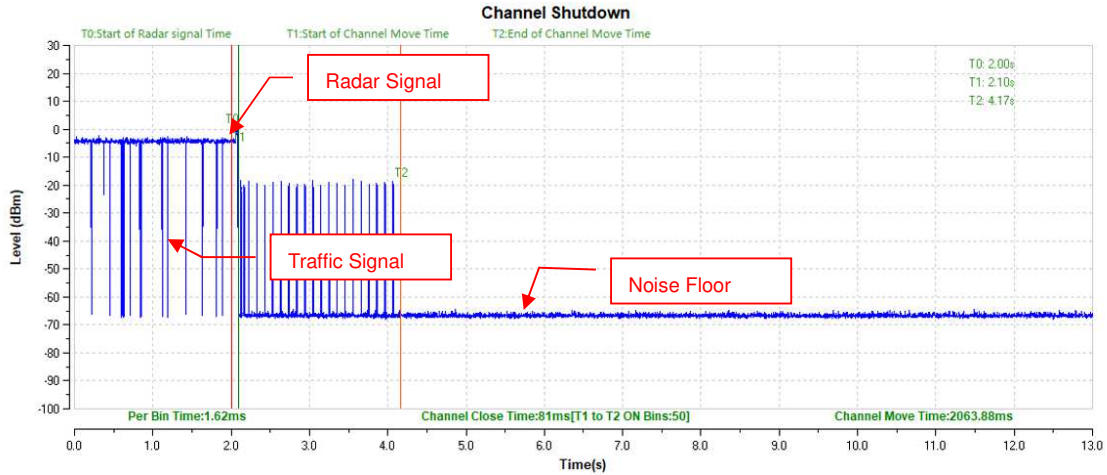

**NOTE:** T0 denotes the start of Radar signal time.  
T1 denotes the data transmissions complete time.  
T2 denotes the end of Channel Move Time.

CH100

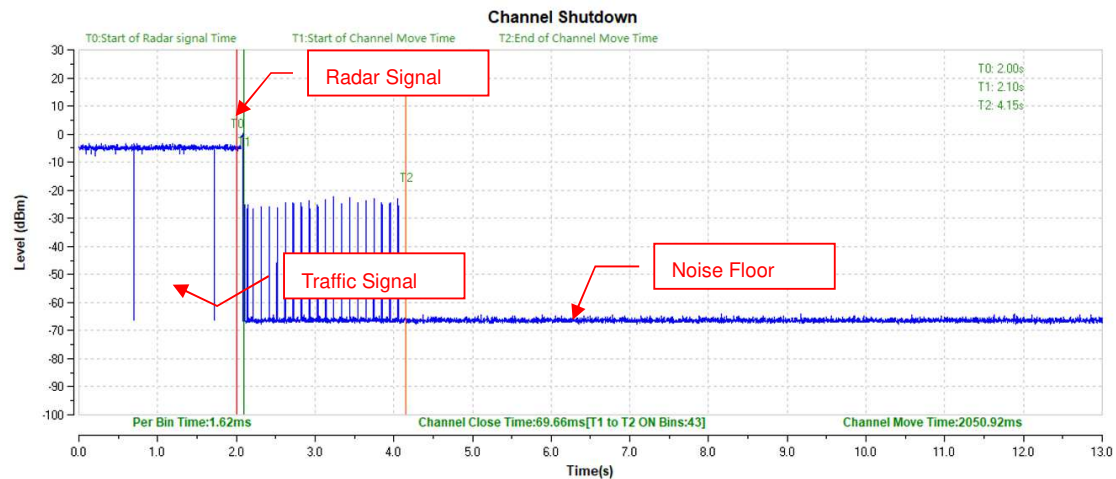

**NOTE:** T0 denotes the start of Radar signal time.  
T1 denotes the data transmissions complete time.  
T2 denotes the end of Channel Move Time.

## 802.11n (HT40) mode CH54

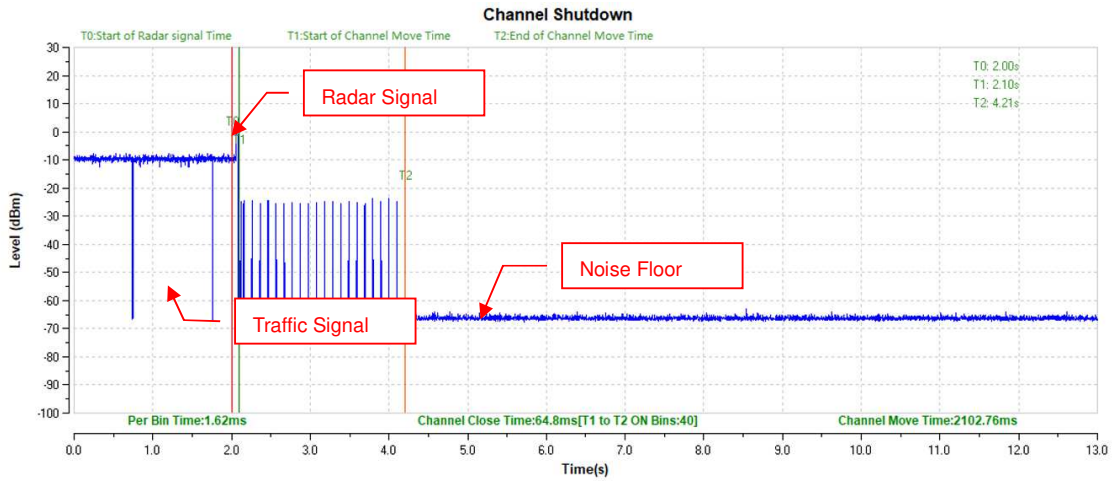

**NOTE:** T0 denotes the start of Radar signal time.  
T1 denotes the data transmissions complete time.  
T2 denotes the end of Channel Move Time.

## CH102

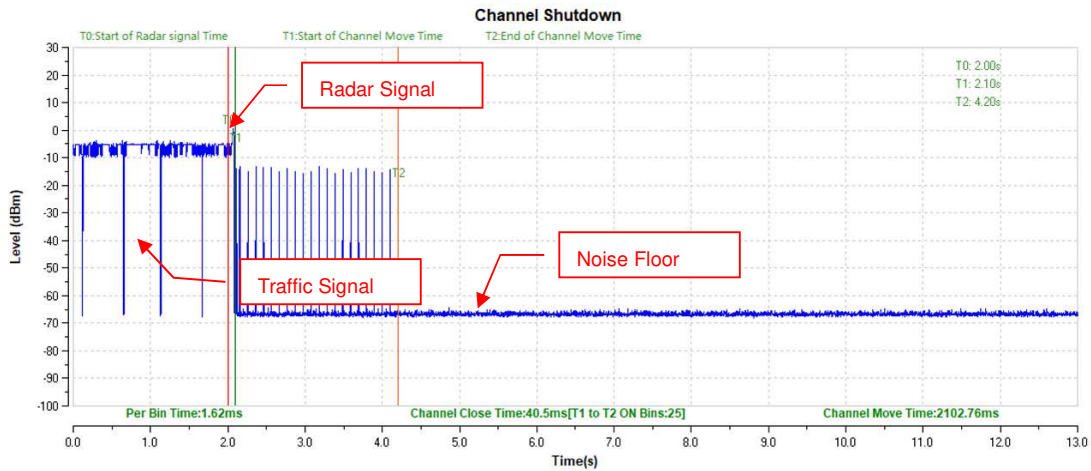

**NOTE:** T0 denotes the start of Radar signal time.  
T1 denotes the data transmissions complete time.  
T2 denotes the end of Channel Move Time.



### 3. PHOTOGRAPHS OF THE TEST CONFIGURATION

#### Dynamic Frequency Selection Test

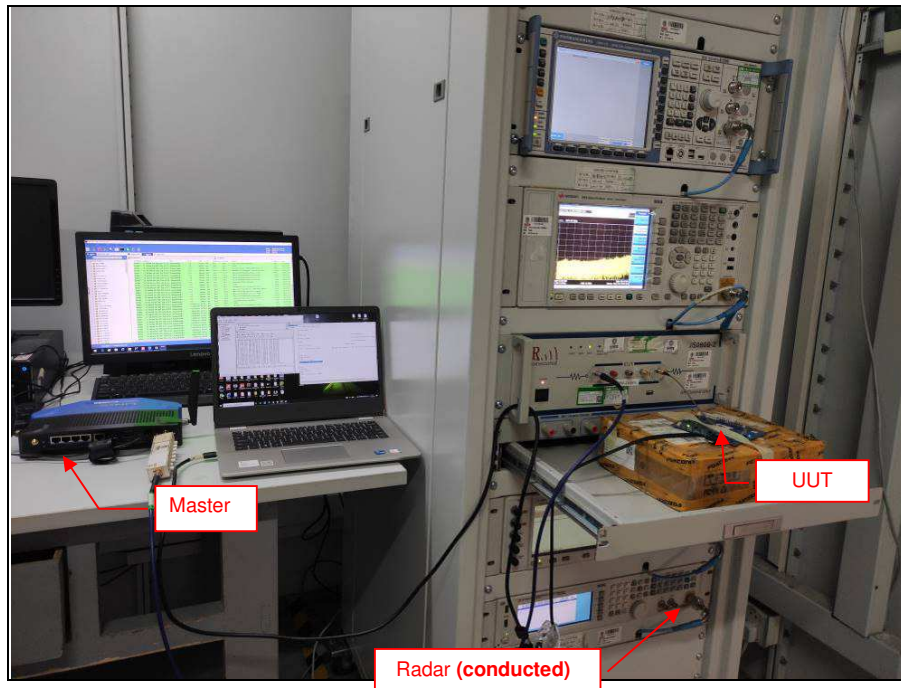



Test Report No.: RE2209WDG0276-5

#### **4. APPENDIX A – MODIFICATIONS RECORDERS FOR ENGINEERING CHANGES TO THE EUT BY THE LAB**

No any modifications were made to the EUT by the lab during the test.

**--- END ---**