

EMC TEST REPORT



Applicant	Particle Industries, Inc
Address	126 Post St, 4th floor, San Francisco, CA 94108 USA

Manufacturer or Supplier	Particle Industries, Inc
Address	126 Post St, 4th floor, San Francisco, CA 94108 USA
Product	Tracker SoM LTE CAT1/3G/2G
Brand Name	Particle
Model Name	T523M/T524M
Date of tests	May. 21, 2020 ~ Jun. 08, 2020

The submitted sample of the above equipment has been tested according to the requirements of the following standards:

- EN 301 489-1 V2.2.3 (2019-11)
- EN 301 489-52 V1.1.0 (2016-11) Draft

CONCLUSION: The submitted sample was found to COMPLY with the test requirement

Prepared by Alex Chen Engineer / Mobile Department	Approved by Luke Lu Manager / Mobile Department
	
Date: Jun. 09, 2020	Date: Jun. 09, 2020

This report is governed by, and incorporates by reference, CPS Conditions of Service as posted at the date of issuance of this report at <http://www.bureauveritas.com/home/about-us/our-business/cps/about-us/terms-conditions> and is intended for your exclusive use. Any copying or replication of this report to or for any other person or entity, or use of our name or trademark, is permitted only with our prior written permission. This report sets forth our findings solely with respect to the test samples identified herein. The results set forth in this report are not indicative or representative of the quality or characteristics of the lot from which a test sample was taken or any similar or identical product unless specifically and expressly noted. Our report includes all of the tests requested by you and the results thereof based upon the information that you provided to us. Measurement uncertainty is only provided upon request for accredited tests. You have 60 days from date of issuance of this report to notify us of any material error or omission caused by our negligence or if you require measurement uncertainty; provided, however, that such notice shall be in writing and shall specifically address the issue you wish to raise. A failure to raise such issue within the prescribed time shall constitute your unqualified acceptance of the completeness of this report, the tests conducted and the correctness of the report contents.



TABLE OF CONTENTS

RELEASE CONTROL RECORD	3
1 SUMMARY OF TEST RESULTS	4
1.1 MEASUREMENT UNCERTAINTY	5
2 GENERAL INFORMATION	6
2.1 GENERAL DESCRIPTION OF EUT	6
2.2 DESCRIPTION OF TEST MODES	7
2.3 TEST PROGRAM USED AND OPERATION DESCRIPTION	9
2.4 PRIMARY CLOCK FREQUENCIES OF INTERNAL SOURCE	9
2.5 CONFIGURATION OF SYSTEM UNDER TEST	10
2.6 DESCRIPTION OF SUPPORT UNIT	11
3 EMISSION TEST	12
3.1 RADIATED DISTURBANCE MEASUREMENT	12
3.1.1 LIMITS OF RADIATED EMISSION MEASUREMENT	12
3.1.2 TEST INSTRUMENTS	13
3.1.3 TEST PROCEDURE	14
3.1.4 DEVIATION FROM TEST STANDARD	15
3.1.5 TEST SETUP	16
3.1.6 EUT OPERATING CONDITIONS	16
3.1.7 TEST RESULTS	17
4 IMMUNITY TEST	20
4.1 GENERAL DESCRIPTION	20
4.2 PERFORMANCE CRITERIA	21
4.3 ELECTROSTATIC DISCHARGE IMMUNITY TEST (ESD)	25
4.3.1 TEST SPECIFICATION	25
4.3.2 TEST INSTRUMENT	25
4.3.3 TEST PROCEDURE	26
4.3.4 DEVIATION FROM TEST STANDARD	26
4.3.5 TEST SETUP	27
4.3.6 TEST RESULTS	28
ESD TEST POINTS	29
4.4 RADIATED, RADIO-FREQUENCY, ELECTROMAGNETIC FIELD IMMUNITY TEST (RS) ...	30
4.4.1 TEST SPECIFICATION	30
4.4.2 TEST INSTRUMENT	30
4.4.3 TEST PROCEDURE	31
4.4.4 DEVIATION FROM TEST STANDARD	31
4.4.5 TEST SETUP	31
4.4.6 TEST RESULTS	32
4.4.7 DATA TRANSFER MEASUREMENT RESULTS	34
5 PHOTOGRAPHS OF THE TEST CONFIGURATION	37
6 APPENDIX A – MODIFICATIONS RECORDERS FOR ENGINEERING CHANGES TO THE EUT BY THE LAB	40



**BUREAU
VERITAS**

Test Report No.: RM200520W002

RELEASE CONTROL RECORD

ISSUE NO.	REASON FOR CHANGE	DATE ISSUED
RM200520W002	Original release	Jun. 09, 2020



1 SUMMARY OF TEST RESULTS

EN 301 489-1 V2.2.3 (2019-11) / Draft EN 301 489-52 V1.1.0 (2016-11), Emission				
Clause	Basic Standard	Phenomenon	Application	Result
8.2	EN 55032:2015 +AC:2016	Radiated emission 30-1000 MHz	Enclosure of ancillary equipment measured on a stand alone basis	Compliance
		Radiated emission 1-6 GHz		Compliance

EN 301 489-1 V2.2.3 (2019-11) / Draft EN 301 489-52 V1.1.0 (2016-11), Immunity				
Clause	Basic Standard	Phenomenon	Application	Result
9.2	EN 61000-4-3:2006 +A1:2008 +A2:2010	RF Electromagnetic Field (80 MHz to 6000) (RS)	Enclosure	Compliance
9.3	EN 61000-4-2:2009	Electrostatic Discharges (ESD)	Enclosure	Compliance



1.1 MEASUREMENT UNCERTAINTY

Where relevant, the following measurement uncertainty levels have been estimated for tests performed on the EUT as specified in CISPR 16-4-2:

The listed uncertainties are the worst case uncertainty for the entire range of measurement. Please note that the uncertainty values are provided for informational purposes only and are not used in determining the PASS/FAIL results.

Measurement	Frequency	Uncertainty
Radiated emissions	30MHz ~1000MHz	±4.98dB
	1GHz ~ 6GHz	±4.70dB

This uncertainty represents an expanded uncertainty expressed at approximately the 95% confidence level using a coverage factor of k=2.



2 GENERAL INFORMATION

2.1 GENERAL DESCRIPTION OF EUT

PRODUCT	Tracker SoM LTE CAT1/3G/2G	
BRAND NAME	Particle	
MODEL NAME	T523M/T524M	
NOMINAL VOLTAGE	Li+ PIN: DC +3.3V--4.3V or Vusb PIN: DC +4.35V--5.5V or Vin PIN: DC +3.9V--17V	
MODULATION TYPE	GSM/GPRS/EDGE	GMSK, 8PSK
	WCDMA	BPSK/QPSK
	LTE	QPSK/16QAM
OPERATING FREQUENCY	GSM	880.2MHz ~ 914.8MHz (FOR GSM 900) 1710.2MHz ~ 1784.8MHz (FOR DCS 1800)
	WCDMA	1922.6MHz~ 1977.4MHz (FOR WCDMA Band 1) 882.4MHz ~ 912.6MHz (FOR WCDMA Band 8)
	LTE	1922.5MHz~ 1977.5MHz (FOR LTE Band1) 1710.7MHz ~ 1784.3MHz (FOR LTE Band3) 2502.5MHz~ 2567.5MHz (FOR LTE Band7) 880.7MHz ~ 914.3MHz (FOR LTE Band8) 834.5MHz~ 859.5MHz (FOR LTE Band20) 704.5MHz ~ 746.5MHz (FOR LTE Band28)
HW VERSION	V1.0	
SW VERSION	V1.5.4	
I/O PORTS	Refer to user's manual	
CABLE SUPPLIED	N/A	

NOTE:

1. For a more detailed features description, please refer to the manufacturer's specifications or the user's manual.
2. The schematic and PCB of the two models T523M and T524M used by our company for the Certification is completely the same ,and the HW&SW used is the same. Because the product is sold in different market using different models eSIM, different models are named. the differences are as follows:T523M uses eSIM of Kore.T524M uses eSIM of Twilio.
3. For the test results, the EUT had been tested with all conditions. But only the worst case was shown in test report.



2.2 DESCRIPTION OF TEST MODES

For Radiated Emission evaluation, the worst data was found at **230Vac/50Hz** and recorded in the applied test report.

For Conducted Emission evaluation, the worst data was found at **230Vac/50Hz** and recorded in the applied test report.

Test Mode	Test Condition
Radiated emission test	
1	GSM 900 Link + Adapter + Battery
2	GSM 1800 Link + Adapter + Battery
3	WCDMA B1 Link + Adapter + Battery
4	WCDMA B8 Link + Adapter + Battery
5	LTE B1 Link + Adapter + Battery
6	LTE B3 Link + Adapter + Battery
7	LTE B7 Link + Adapter + Battery
8	LTE B8 Link + Adapter + Battery
9	LTE B20 Link + Adapter + Battery
10	LTE B28 Link + Adapter + Battery
11	GSM 900 Link + Laptop + Battery
NOTE:	
1. For radiated emission test, test mode 1 was the worst case and only this mode was presented in this report.	

Test Mode	Test Condition
ESD test	
1	GSM 900 Link + Adapter + Battery
2	GSM 1800 Link + Adapter + Battery
3	WCDMA B1 Link + Adapter + Battery
4	WCDMA B8 Link + Adapter + Battery
5	LTE B1 Link + Adapter + Battery
6	LTE B3 Link + Adapter + Battery
7	LTE B7 Link + Adapter + Battery
8	LTE B8 Link + Adapter + Battery
9	LTE B20 Link + Adapter + Battery
10	LTE B28 Link + Adapter + Battery
11	GSM 900 Link + Laptop + Battery



RS test	
1	GSM 900 Link + Adapter + Battery + BLER
2	GSM 1800 Link + Adapter + Battery + BLER
3	WCDMA B1 Link + Adapter + Battery + BLER
4	WCDMA B8 Link + Adapter + Battery + BLER
5	LTE B1 Link + Adapter + Battery + Throughput
6	LTE B3 Link + Adapter + Battery + Throughput
7	LTE B7 Link + Adapter + Battery + Throughput
8	LTE B8 Link + Adapter + Battery + Throughput
9	LTE B20 Link + Adapter + Battery + Throughput
10	LTE B28 Link + Adapter + Battery + Throughput
11	GSM 900 Link + Laptop + Battery + Throughput



2.3 TEST PROGRAM USED AND OPERATION DESCRIPTION

<Emission Tests>

- a. The EUT was charged from the adapter when the mode was tested.
- b. The computer was applied for monitoring purpose when the mode was tested

<Immunity Tests>

- a. The EUT was charged from the adapter when the mode was tested.
- b. The computer was applied for monitoring purpose when the mode was tested

2.4 PRIMARY CLOCK FREQUENCIES OF INTERNAL SOURCE

The highest frequency generated or used within the EUT or on which the EUT operates or tunes is 5000 MHz, provided by the manufacturer, for detailed internal source, please refer to the manufacturer's specifications.



2.5 CONFIGURATION OF SYSTEM UNDER TEST

FOR EMISSION TESTS

Radiation Worst Case Mode 1

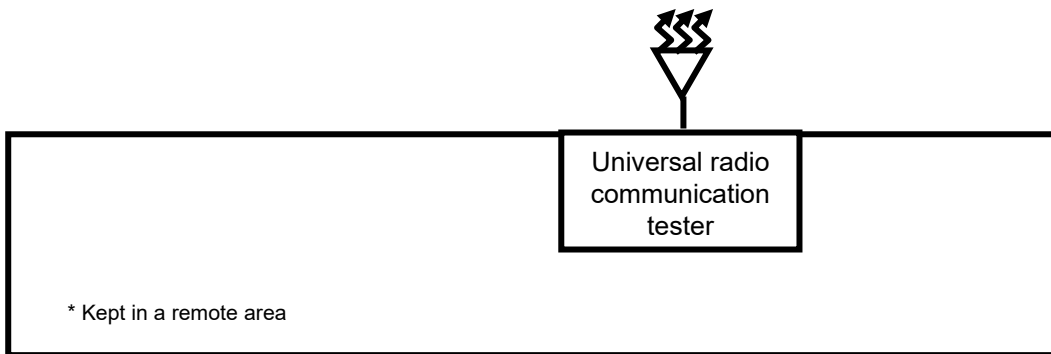
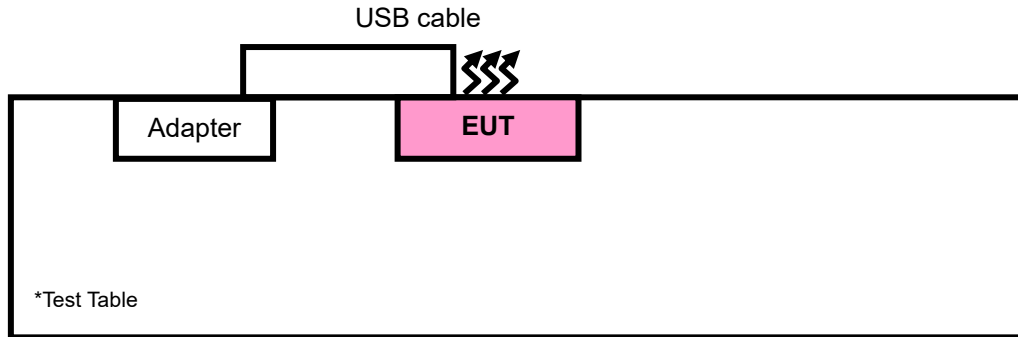



2.6 DESCRIPTION OF SUPPORT UNIT

The EUT has been tested as an independent unit together with other necessary accessories or support units. The following support units or accessories were used to form a representative test configuration during the tests.

FOR ALL TESTS

NO.	PRODUCT	BRAND	MODEL NO.	SERIAL NO.	FCC ID
1	Adapter	VIVO	V0510B-EU	N/A	N/A
2	Universal radio communication tester	Rohde&Schwarz	CMW500	N/A	N/A

NO.	SIGNAL CABLE DESCRIPTION OF THE ABOVE SUPPORT UNITS
1	N/A
2	N/A



3 EMISSION TEST

3.1 RADIATED DISTURBANCE MEASUREMENT

3.1.1 LIMITS OF RADIATED EMISSION MEASUREMENT

FOR FREQUENCY BELOW 1000 MHz

Frequency (MHz)	Class A (at 10m)	Class B (at 10m)
	Quasi-peak (dBuV/m)	Quasi-peak (dBuV/m)
30-230	40	30
230-1000	47	37
Frequency (MHz)	Class A (at 3m)	Class B (at 3m)
	Quasi-peak (dBuV/m)	Quasi-peak (dBuV/m)
30-230	50	40
230-1000	57	47

FOR FREQUENCY ABOVE 1000 MHz

Frequency (MHz)	Class A (at 3m)		Class B (at 3m)	
	Peak (dBuV/m)	Average (dBuV/m)	Peak (dBuV/m)	Average (dBuV/m)
1000-3000	76	56	70	50
3000-6000	80	60	74	54

- NOTE:**
1. The lower limit shall apply at the transition frequencies.
 2. Emission level (dBuV/m) = 20 log Emission level (uV/m).
 3. All emanations from a class A/B digital device or system, including any network of conductors and apparatus connected thereto, shall not exceed the level of field strengths specified above.



FREQUENCY RANGE OF RADIATED MEASUREMENT

Highest frequency generated or used within the EUT or on which the EUT operates or tunes (MHz)	Upper frequency of measurement range (MHz)
Below 108	1000
108-500	2000
500-1000	5000
Above 1000	Up to 5 times of the highest frequency or 6 GHz, whichever is less

3.1.2 TEST INSTRUMENTS

Frequency range below 1GHz

Equipment	Manufacturer	Model No.	Serial No.	Last Cal.	Next Cal.
3m Semi-anechoic Chamber	ETS-LINDGREN	9m*6m*6m	Euroshieldpn-CT0001143-1216	Feb. 28,20	Feb. 27,21
Bilog Antenna	ETS-LINDGREN	3143B	00161965	Feb. 28,20	Feb. 27,21
MXE EMI Receiver	KEYSIGHT	N9038A-544	MY54450026	Feb. 28,20	Feb. 27,21
Signal Pre-Amplifier	EMSI	EMC 9135	980249	Jun. 24,19	Jun. 23,20

Frequency range above 1GHz

Equipment	Manufacturer	Model No.	Serial No.	Last Cal.	Next Cal.
3m Semi-anechoic Chamber	ETS-LINDGREN	9m*6m*6m	Euroshieldpn-CT0001143-1216	Feb. 28,20	Feb. 27,21
Horn Antenna	ETS-LINDGREN	3117	00168728	Feb. 28,20	Feb. 27,21
MXE EMI Receiver	KEYSIGHT	N9038A-544	MY54450026	Feb. 28,20	Feb. 27,21
Signal Pre-Amplifier	EMSI	EMC 012645B	980257	Jun. 24,19	Jun. 23,20

NOTE: The test was performed in 3m Chamber.



3.1.3 TEST PROCEDURE

Frequency range 30MHz~1GHz

- a. The EUT was placed on the top of a rotating table 0.8 meters above the ground at a 3 meter semi-anechoic chamber room. The table was rotated 360 degrees to determine the position of the highest radiation.
- b. The EUT was set 3 meters away from the interference-receiving antenna, which was mounted on the top of a variable-height antenna tower.
- c. The height of antenna is varied from 1 meter to 4 meters above the ground to determine the maximum value of the field strength. Both horizontal and vertical polarizations of the antenna are set to make the measurement.
- d. For each suspected emission, the EUT was arranged to its worst case and then the antenna was tuned to heights from 1 meter to 4 meters and the rotatable table was turned from 0 degrees to 360 degrees to find the maximum reading.
- e. The test-receiver system was set to quasi-peak detect function and specified bandwidth with maximum hold mode when the test frequency is below 1GHz.

NOTE:

1. The resolution bandwidth of test receiver/spectrum analyzer is 120kHz for Quasi-peak detection (QP) at frequency below 1GHz.
2. Emission level(dBuV/m)=Raw Value(dBuV) + Correction Factor(dB/m)
3. Correction Factor(dB/m) = Antenna Factor (dB/m) + Cable Factor (dB) (if the raw value not contains the amplifier);
4. Correction Factor (dB/m) = Antenna Factor (dB/m) + Cable Factor (dB) – Amplifier Gain (dB) (if the raw value contains the amplifier).
5. Margin value = Emission level – Limit value.



Frequency range above 1GHz

- a. The EUT was placed on the top of a rotating table 0.8 meters above the ground at a 3 meter Fully-anechoic chamber room. The table was rotated 360 degrees to determine the position of the highest radiation.
- b. The EUT was set 3 meters away from the interference-receiving antenna, which was mounted on the top of a variable-height antenna tower.
- c. The height of antenna can be varied from 1 meter to 4 meters, the height of adjustment depends on the EUT height and the antenna 3dB beamwidth both, to detect the maximum value of the field strength. Both horizontal and vertical polarizations of the antenna are set to make the measurement. The bore sight should be used during the test above 1GHz.
- d. For each suspected emission, the EUT was arranged to its worst case and then the antenna was tuned to heights and the rotatable table was turned from 0 degrees to 360 degrees to find the maximum reading.
- e. The test receiver/spectrum was set to peak and average detect function and specified bandwidth with maximum hold mode when the test frequency is above 1GHz.

NOTE:

1. The resolution bandwidth is 1MHz and video bandwidth of test receiver/spectrum analyzer is 3MHz for Peak detection at frequency above 1GHz. The resolution bandwidth of test receiver/spectrum analyzer is 1 MHz for Average detection (AV) at frequency above 1GHz.
2. For measurement of frequency above 1000 MHz, the EUT was set 3 meters away from the receiver antenna.
3. Emission level(dBuV/m)=Raw Value(dBuV) + Correction Factor(dB/m)
4. Correction Factor(dB/m) = Antenna Factor (dB/m) + Cable Factor (dB) (if the raw value not contains the amplifier);
5. Correction Factor (dB/m) = Antenna Factor (dB/m) + Cable Factor (dB) – Amplifier Gain(dB) (if the raw value contains the amplifier).
6. Margin value = Emission level – Limit value.

3.1.4 DEVIATION FROM TEST STANDARD

No deviation.



3.1.5 TEST SETUP

<Frequency Range below 1GHz>

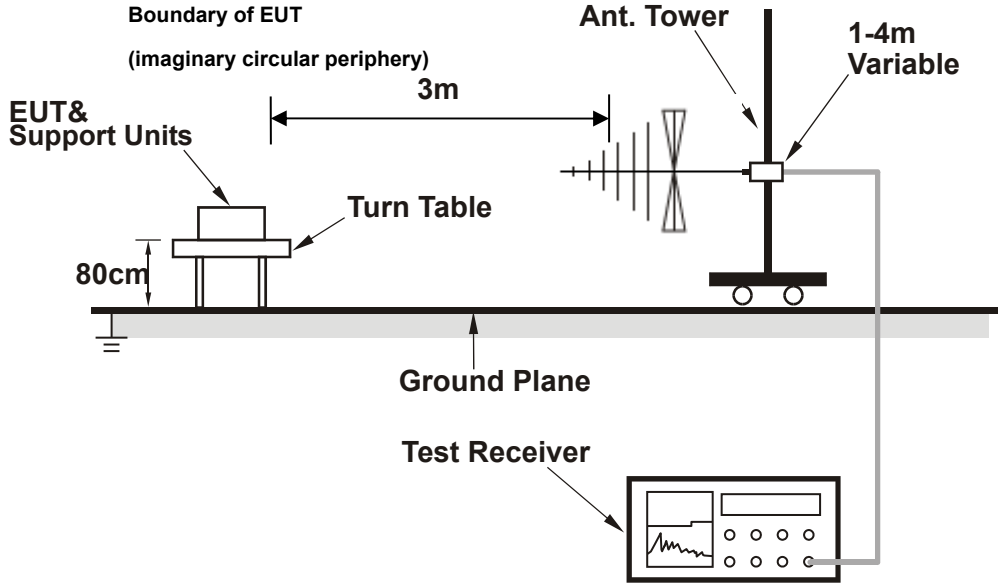

<Frequency Range above 1GHz>

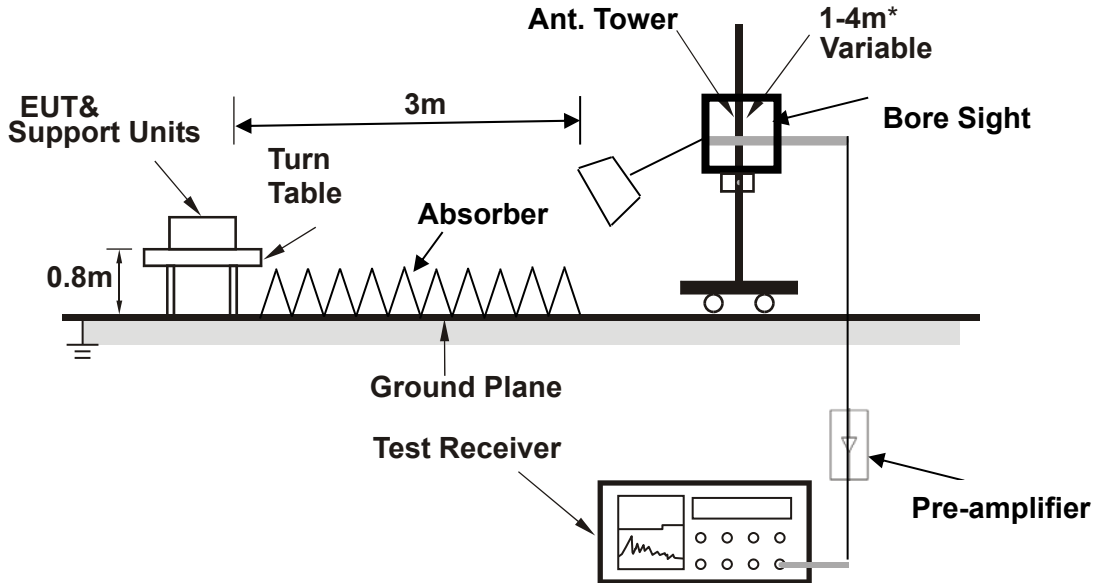

Note: Above 1G is a directional antenna

* depends on the EUT height and the antenna 3dB beam width both, refer to section 7.3 of CISPR

16-2-3.

3.1.6 EUT OPERATING CONDITIONS

Same as clause 3.3



3.1.7 TEST RESULTS

Below 1GHz worst case data

TEST VOLTAGE	Input 230 Vac, 50 Hz	FREQUENCY RANGE	30-1000 MHz
ENVIRONMENTAL CONDITIONS	23deg. C, 70% RH	DETECTOR FUNCTION & RESOLUTION BANDWIDTH	Quasi-Peak , 120 kHz
TESTED BY	Tony		

ANTENNA POLARITY & TEST DISTANCE: HORIZONTAL AT 3 M										
FREQ. (MHz)	EMISSION LEVEL (dBuV/m)	READ LEVEL (dBuV)	LIMIT (dBuV/m)	MARGIN (dB)	ANTENNA FACTOR (dB /m)	CABLE LOSS (dB)	PREAMP FACTOR (dB)	ANTENNA HEIGHT (cm)	TABLE ANGLE (Degree)	REMARK
36.79	34.71	57.39	40	-5.29	14.01	0.88	37.57	200	123	QP
73.65	22.53	50.94	40	-17.47	7.72	1.2	37.33	200	88	QP
166.77	30.65	55.25	40	-9.35	10.43	1.67	36.7	200	100	QP
249.22	34.43	56.07	47	-12.57	12.97	2.04	36.65	200	165	QP
288.99	27.58	48.28	47	-19.42	13.86	2.17	36.73	200	201	QP
422.85	25.67	42.34	47	-21.33	17.5	2.7	36.87	200	235	QP

- REMARKS:**
1. Emission level(dBuV/m)=Read Value(dBuV) + Correction Factor(dB/m)
 2. Correction Factor(dB/m) = Antenna Factor (dB/m) + Cable Factor (dB)– Amplifier Gain
 3. The other emission levels were very low against the limit.
 4. Margin value = Emission level – Limit value.

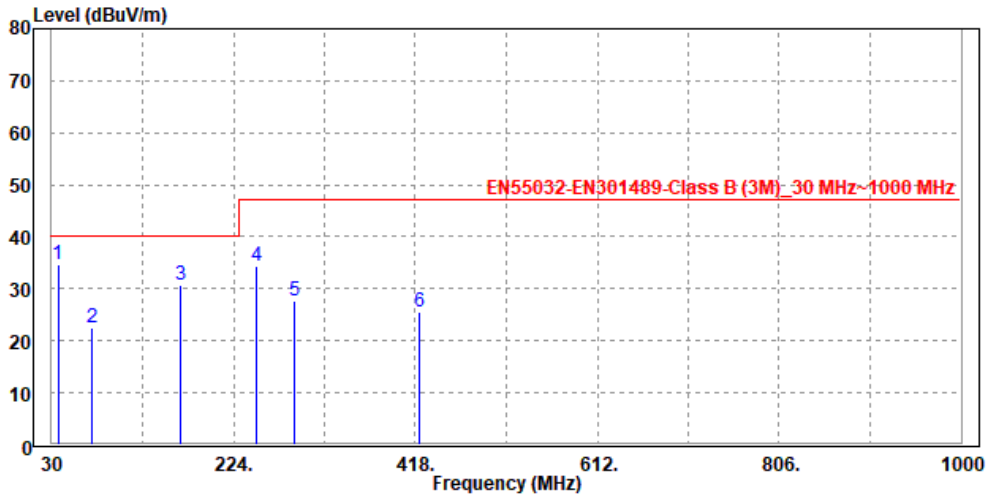



TEST VOLTAGE	Input 230 Vac, 50 Hz	FREQUENCY RANGE	30-1000 MHz
ENVIRONMENTAL CONDITIONS	23deg. C, 70% RH	DETECTOR FUNCTION & RESOLUTION BANDWIDTH	Quasi-Peak , 120 kHz
TESTED BY	Tony		

ANTENNA POLARITY & TEST DISTANCE: VERTICAL AT 3 M										
FREQ. (MHz)	EMISSION LEVEL (dBuV/m)	READ LEVEL (dBuV)	LIMIT (dBuV/m)	MARGIN (dB)	ANTENNA FACTOR (dB /m)	CABLE LOSS (dB)	PREAMP FACTOR (dB)	ANTENNA HEIGHT (cm)	TABLE ANGLE (Degree)	REMARK
31.94	32.19	52.67	40	-7.81	16.14	0.8	37.42	100	65	QP
68.8	31.88	60.53	40	-8.12	7.5	1.18	37.33	100	133	QP
164.83	31.55	56.19	40	-8.45	10.4	1.67	36.71	100	102	QP
191.99	29.57	53.77	40	-10.43	10.64	1.75	36.59	100	97	QP
211.39	27.05	50.42	40	-12.95	11.35	1.85	36.57	100	135	QP
289.96	26.1	46.65	47	-20.9	14	2.18	36.73	100	198	QP

- REMARKS:**
1. Emission level(dBuV/m)=Read Value(dBuV) + Correction Factor(dB/m)
 2. Correction Factor(dB/m) = Antenna Factor (dB/m) + Cable Factor (dB) –Amplifier Gain
 3. The other emission levels were very low against the limit.
 4. Margin value = Emission level – Limit value.

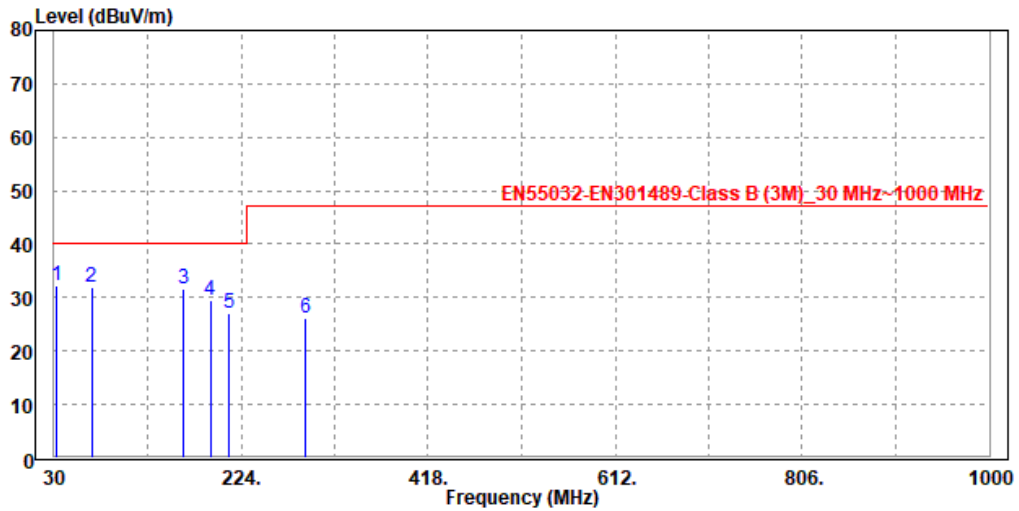



Above 1GHz worst case data

TEST VOLTAGE	Input 230 Vac, 50 Hz	FREQUENCY RANGE	1-6 GHz
ENVIRONMENTAL CONDITIONS	23deg. C, 70% RH	DETECTOR FUNCTION & RESOLUTION BANDWIDTH	Peak/Average, 1 MHz
TESTED BY	Tony		

ANTENNA POLARITY & TEST DISTANCE: HORIZONTAL AT 3 M

FREQ. (MHz)	EMISSION LEVEL (dBuV/m)	READ LEVEL (dBuV)	LIMIT (dBuV/m)	MARGIN (dB)	ANTENNA FACTOR (dB /m)	CABLE LOSS (dB)	PREAMP FACTOR (dB)	ANTENNA HEIGHT (cm)	TABLE ANGLE (Degree)	REMARK
1925	54.57	64.74	70	-15.43	31.82	4.41	46.4	100	0	Peak
1925	28.73	38.9	50	-21.27	31.82	4.41	46.4	100	0	Average
2320	51.02	59.6	70	-18.98	32.98	4.81	46.37	100	0	Peak
2320	29.85	38.43	50	-20.15	32.98	4.81	46.37	100	0	Average
2740	44.27	51.62	70	-25.73	33.35	5.25	45.95	100	0	Peak
2740	31.17	38.52	50	-18.83	33.35	5.25	45.95	100	0	Average
3265	44.45	50.56	74	-29.55	34.14	5.72	45.97	100	0	Peak
3265	32.42	38.53	54	-21.58	34.14	5.72	45.97	100	0	Average
3590	54.53	59.6	74	-19.47	35.36	5.95	46.38	100	0	Peak
3590	33.23	38.3	54	-20.77	35.36	5.95	46.38	100	0	Average
3985	47.55	50.61	74	-26.45	37.81	5.51	46.38	100	0	Peak
3985	34.9	37.96	54	-19.1	37.81	5.51	46.38	100	0	Average

ANTENNA POLARITY & TEST DISTANCE: VERTICAL AT 3 M

FREQ. (MHz)	EMISSION LEVEL (dBuV/m)	READ LEVEL (dBuV)	LIMIT (dBuV/m)	MARGIN (dB)	ANTENNA FACTOR (dB /m)	CABLE LOSS (dB)	PREAMP FACTOR (dB)	ANTENNA HEIGHT (cm)	TABLE ANGLE (Degree)	REMARK
2335	49.04	58.52	70	-20.96	32.07	4.82	46.37	200	0	Peak
2335	28.74	38.22	50	-21.26	32.07	4.82	46.37	200	0	Average
2920	43.75	51.2	70	-26.25	32.75	5.44	45.64	200	0	Peak
2920	30.85	38.3	50	-19.15	32.75	5.44	45.64	200	0	Average
3595	53.57	60.04	74	-20.43	33.95	5.96	46.38	200	0	Peak
3595	31.59	38.06	54	-22.41	33.95	5.96	46.38	200	0	Average
4005	45.73	50.3	74	-28.27	36.3	5.51	46.38	200	0	Peak
4005	33.01	37.58	54	-20.99	36.3	5.51	46.38	200	0	Average
4545	44.99	49.67	74	-29.01	35.93	5.78	46.39	200	0	Peak
4545	33.27	37.95	54	-20.73	35.93	5.78	46.39	200	0	Average
5100	47.18	49.88	74	-26.82	36.26	7.41	46.37	200	0	Peak
5100	35.27	37.97	54	-18.73	36.26	7.41	46.37	200	0	Average

- REMARKS:
1. Emission level(dBuV/m)=Raw Value(dBuV) + Correction Factor(dB/m)
 2. Correction Factor(dB/m) = Antenna Factor (dB/m) + Cable Factor (dB)- Amplifier Gain
 3. The other emission levels were very low against the limit.
 4. Margin value = Emission level – Limit value.



4 IMMUNITY TEST

4.1 GENERAL DESCRIPTION

EN 301 489-1 V2.2.3 (2019-11) / Draft EN 301 489-52 V1.1.0 (2016-11), Immunity requirements			
Clause	Reference standard	Test specification	Performance Criterion
9.3	EN 61000-4-2 ESD	Enclosure port: ±8 kV Air discharge, ±4 kV Contact discharge	TT/TR
9.2	EN 61000-4-3 RS	Enclosure port: 80-6000 MHz, 3 V/m, 80 % AM (1 kHz)	CT/CR



4.2 PERFORMANCE CRITERIA

General Performance Criteria

- Performance criteria for continuous phenomena applied to transmitters and receivers (CT/CR)
During and after the test, the apparatus shall continue to operate as intended. No degradation of performance or loss of function is allowed below a permissible performance level specified by the manufacturer when the apparatus is used as intended. In some cases this permissible performance level may be replaced by a permissible loss of performance.
During the test the EUT shall not unintentionally transmit or change its actual operating state and stored data.
If the minimum performance level or the permissible performance loss is not specified by the manufacturer, then either of these may be deduced from the product description and documentation and what the user may reasonably expect from the apparatus if used as intended.
- Performance criteria for transient phenomena applied to transmitters and receivers (TT/TR)
After the test, the apparatus shall continue to operate as intended. No degradation of performance or loss of function is allowed below a permissible performance level specified by the manufacturer, when the apparatus is used as intended. In some cases this permissible performance level may be replaced by a permissible loss of performance.
During the EMC exposure to an electromagnetic phenomenon, a degradation of performance is, however, allowed. No change of the actual mode of operation (e.g. unintended transmission) or stored data is allowed.
If the minimum performance level or the permissible performance loss is not specified by the manufacturer, then either of these may be deduced from the product description and documentation and what the user may reasonably expect from the apparatus if used as intended.
- Performance criteria for equipment which does not provide a continuous communication Link
For radio equipment which does not provide a continuous communication Link, the performance criteria described in CT/CR and TT/TR are not appropriate, then the manufacturer shall declare, for inclusion in the test report, his own specification for an acceptable level of performance or degradation of performance during and/or after the immunity tests.
The performance criteria specified by the manufacturer shall give the same degree of immunity protection as called for in CT/CR and TT/TR.
- Performance criteria for ancillary equipment tested on a stand alone basis
If ancillary equipment is intended to be tested on a stand alone basis, the performance criteria described in CT/CR and TT/TR are not appropriate, then the manufacturer shall declare, for inclusion in the test report, his own specification for an acceptable level of performance or degradation of performance during and/or after the immunity tests.
The performance criteria specified by the manufacturer shall give the same degree of immunity protection as called for in CT/CR and TT/TR.



Product Specific Performance Criteria

The particular performance criteria which are specified in the relevant part of EN 301 489 series dealing with the particular type of radio equipment, take precedence over the corresponding parts of the general performance criteria.

Where particular performance criteria for specific functions are not given, then the general performance criteria shall apply.

EN 301 489-52, GSM and DCS

The equipment shall meet the performance criteria specified in this clause.

Portable equipment intended for use whilst powered by the main battery of a vehicle shall additionally fulfill the applicable requirements set out in EN 301 489-1, clauses 7.1 and 7.2 for mobile equipment.

Portable or mobile equipment powered by the AC mains shall additionally fulfill the applicable requirements of

EN 301 489-1, clauses 7.1 and 7.2 for radio and ancillary equipment for fixed use.

The establishment and maintenance of a communications Link, the assessment of RXQUAL, and the assessment of the audio breakthrough by monitoring the speech output signal level, are used as performance criteria to ensure that all primary functions of the transmitter and receiver are evaluated during the immunity tests. In addition, the test shall also be performed in idle mode to ensure the transmitter does not unintentionally operate.

The maintenance of a communications Link shall be assessed using an indicator which may be part of the test system or the EUT.

If an equipment is of a specialized nature, such that the performance criteria described in the following clauses are not appropriate, then the manufacturer shall declare, for inclusion in the test report, his own specification for an acceptable level of performance or degradation of performance during and/or after the immunity tests. The performance specification shall be included in the product description and documentation.

The performance criteria specified by the manufacturer shall give the same degree of immunity protection as called for in the following clauses.



The phenomena allowed during and after test are stated in the following table.

Special conditions for EN301489-52	
Criteria	During / After Test
CT	<p>A communication Link shall be established at the start of the test, and maintained during the test, see clauses 4.2.3 and 4.2.4.</p> <p>During the test, the upLink speech output level shall be at least 35 dB less than the previously recorded reference levels, when measured through an audio band pass filter of width 200 Hz, centred on 1 kHz.</p> <p>Note: When there is a high level background noise present the filter bandwidth can be reduced down to a minimum of 40 Hz.</p> <p>At the conclusion of the test, the EUT shall operate as intended with no loss of user control functions or stored data, and the communication Link shall have been maintained. In addition to confirming the above performance during a call, the test shall also be performed in idle mode, and the transmitter shall not unintentionally operate.</p>
TT	<p>A communications Link shall be established at the start of the test, see clauses 4.2 to 4.2.4.</p> <p>At the conclusion of each exposure the EUT shall operate with no user noticeable loss of the communication Link.</p> <p>At the conclusion of the total test comprising the series of individual exposures, the EUT shall operate as intended with no loss of user control functions or stored data, as declared by the manufacturer, and the communication Link shall have been maintained.</p> <p>In addition to confirming the above performance during a call, the test shall also be performed in idle mode, and the transmitter shall not unintentionally operate.</p>
CR	<p>A communications Link shall be established at the start of the test, clauses 4.2 to 4.2.6.</p> <p>During the test, the RXQUAL of the downLink shall not exceed the value of three, measured during each individual exposure in the test sequence.</p> <p>During the test, the downLink speech output level shall be at least 35 dB less than the previously recorded reference levels, when measured through an audio band pass filter of width 200 Hz, centred on 1 kHz.</p> <p>Note: When there is a high level background noise present the filter bandwidth can be reduced down to a minimum of 40 Hz.</p> <p>At the conclusion of the test, the EUT shall operate, as intended with no loss of user control functions or stored data, and the communication Link shall have been maintained.</p>
TR	<p>A communications Link shall be established at the start of the test, clauses 4.2 to 4.2.6.</p> <p>At the conclusion of each exposure the EUT shall operate with no user noticeable loss of the communication Link.</p> <p>At the conclusion of the total test comprising the series of individual exposures, the EUT shall operate as intended with no loss of user control functions or stored data, as declared by the manufacturer, and the communication Link shall have been maintained.</p>
Ancillary equipment tested on a stand alone bases	The provision of EN 301 489-1, clause 6.4 shall apply.



EN 301 489-52, UTRA and E-UTRA, Mobile and Portable UE

The equipment shall meet the performance criteria specified in this clause.

The maintenance of a communications Link shall be assessed by using an indicator, which may be part of the test system or the equipment under test.

If an equipment is of a specialized nature, that the performance criteria described in the following clauses are not appropriate, then the manufacturer shall declare, for inclusion in the test report, his own specification for an acceptable level of performance or degradation of performance during and/or after testing, as required by the present document.

The performance criteria specified by the manufacturer shall give the same degree of immunity protection as called for in the following clauses.

In addition, the test shall also be performed in idle mode to ensure the transmitter does not unintentionally operate.

The requirements apply to all types of UTRA and E-UTRA (FDD or TDD) for the UE.

Special conditions for EN301489-52	
Criteria	During / After Test
CT/CR	<p>A communication Link shall be established at the start of the test, and maintained during the test. In the speech mode, the performance criteria shall be that the Up Link and Down Link speech output levels shall be at least 35 dB less than the recorded reference levels, when measured through an audio band pass filter of width 200 Hz, centred on 1 kHz (annex B).</p> <p>Note: When there is a high level of background audio noise present, the filter bandwidth can be reduced down to a minimum of 40 Hz.</p> <p>At the conclusion of the test, the EUT shall operate as intended with no loss of user control functions or stored data, and the communication Link shall have been maintained.</p> <p>In addition to confirming the above performance in traffic mode, the test shall be performed in idle mode, and the transmitter shall not unintentionally operate.</p> <ul style="list-style-type: none"> • UTRA <p>In the data transfer mode, the performance criteria can be one of the following:</p> <ul style="list-style-type: none"> - if the BER (as referred in TS 134 109) is used, it shall not exceed 0,001 during the test sequence; - if the BLER (as referred in TS 134 109) is used, it shall not exceed 0,01 during the test sequence. <p>The BLER calculation shall be based on evaluating the CRC on each transport block.</p> <ul style="list-style-type: none"> • E-UTRA <p>In the data transfer mode, the performance criteria shall be that the throughput shall be $\geq 95\%$ of the maximum throughput of the reference measurement channel as specified in annex C in TS 136 101 with parameters specified in tables 7.3.1-1 and 7.3.1-2 in TS 136 101 during the test sequence.</p>
TT/TR	<p>A communications Link shall be established at the start of the test.</p> <p>At the conclusion of each exposure the EUT shall operate with no user noticeable loss of the communication Link.</p> <p>At the conclusion of the total test comprising the series of individual exposures, the EUT shall operate as intended with no loss of user control functions or stored data, as declared by the manufacturer, and the communication Link shall have been maintained.</p> <p>In addition to confirming the above performance in traffic mode, the test shall also be performed</p>



4.3 ELECTROSTATIC DISCHARGE IMMUNITY TEST (ESD)

4.3.1 TEST SPECIFICATION

Basic Standard:	EN 61000-4-2
Discharge Impedance:	330 ohm / 150 pF
Discharge Voltage:	Air Discharge: 2, 4, 8 kV (Direct) Contact Discharge: 2, 4 kV Indirect Discharge: 2, 4kV
Polarity:	Positive & Negative
Number of Discharge:	Minimum 20 times at each test point
Discharge Mode:	Single Discharge
Discharge Period:	1 second minimum

4.3.2 TEST INSTRUMENT

Equipment	Manufacturer	Model No.	Serial No.	Last Cal.	Next Cal.
ESD GUN	TESEQ	NSG 438	1399	Feb. 28,20	Feb. 27,21
ESD GUN-POWER	TESEQ	NSG 438-ACC	NA	Feb. 28,20	Feb. 27,21

NOTE: 1. The test was performed in EMS Room.



4.3.3 TEST PROCEDURE

- a. Electrostatic discharges were applied only to those points and surfaces of the EUT that are accessible to users during normal operation.
- b. The test was performed with at least ten single discharges on the pre-selected points in the most sensitive polarity.
- c. The time interval between two successive single discharges was at least 1 second.
- d. The ESD generator was held perpendicularly to the surface to which the discharge was applied and the return cable was at least 0.2 meters from the EUT.
- e. Contact discharges were applied to the non-insulating coating, with the pointed tip of the generator penetrating the coating and contacting the conducting substrate.
- f. Air discharges were applied with the round discharge tip of the discharge electrode approaching the EUT as fast as possible (without causing mechanical damage) to touch the EUT. After each discharge, the ESD generator was removed from the EUT and re-triggered for a new single discharge. The test was repeated until all discharges were complete.
- g. At least ten single discharges (in the most sensitive polarity) were applied to the **Horizontal Coupling Plane** at points on each side of the EUT. The ESD generator was positioned horizontally at a distance of 0.1 meters from the EUT with the discharge electrode touching the **HCP**.
- h. At least ten single discharges (in the most sensitive polarity) were applied to the center of one vertical edge of the **Vertical Coupling Plane** in sufficiently different positions that the four faces of the EUT were completely illuminated. The **VCP** (dimensions 0.5m x 0.5m) was placed vertically to and 0.1 meters from the EUT.

4.3.4 DEVIATION FROM TEST STANDARD

No deviation.

4.3.5 TEST SETUP

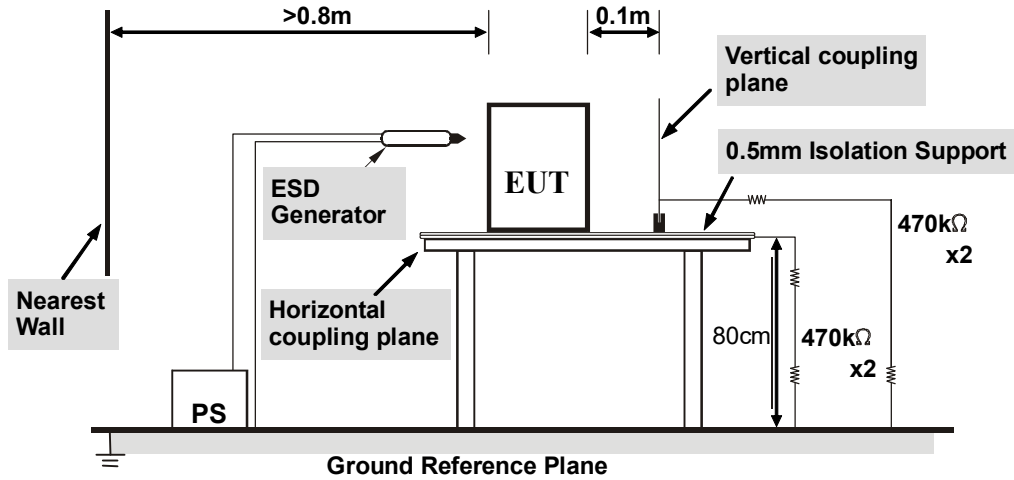

NOTE:

TABLE-TOP EQUIPMENT

The configuration consisted of a wooden table 0.8 meters high standing on the **Ground Reference Plane**. The **GRP** consisted of a sheet of aluminum or copper at least 0.25mm thick, and 2.5 meters square connected to the protective grounding system. A **Horizontal Coupling Plane** (1.6m x 0.8m) was placed on the table and attached to the **GRP** by means of a cable with 940kΩ total impedance. The equipment under test, was installed in a representative system as described in section 7 of IEC 61000-4-2, and its cables were placed on the **HCP** and isolated by an insulating support of 0.5mm thickness. A distance of 0.8 meter minimum was provided between the EUT and the walls of the laboratory and any other metallic structure.

FLOOR-STANDING EQUIPMENT

The equipment under test was installed in a representative system as described in section 7 of IEC 61000-4-2, and its cables were isolated from the Ground Reference Plane by an insulating support of 0.1-meter thickness. The GRP consisted of a sheet of aluminum or copper that is at least 0.25mm thick, and 2.5 meters square connected to the protective grounding system and extended at least 0.5 meters from the EUT on all sides.



4.3.6 TEST RESULTS

TEST VOLTAGE	Input 230 Vac, 50 Hz	ENVIRONMENTAL CONDITIONS	23deg. C, 53% RH, 101kpa
TEST MODE	See section 2.2	TESTED BY	Chase Zhou

Discharge Level	Polarity	Test Points	Contact Discharge	Air Discharge	Performance Criterion	Test Result
2,4	+/-	HCP	Apply	N/A	TT/TR	Complied
2,4	+/-	VCP	Apply	N/A	TT/TR	Complied

NOTE: 1. The EUT function was correct during the test.



**BUREAU
VERITAS**

Test Report No.: RM200520W002

ESD TEST POINTS





4.4 RADIATED, RADIO-FREQUENCY, ELECTROMAGNETIC FIELD IMMUNITY TEST (RS)

4.4.1 TEST SPECIFICATION

Basic Standard:	EN 61000-4-3
Frequency Range:	80 MHz ~ 6000 MHz
Field Strength:	3 V/m
Modulation:	1 kHz Sine Wave, 80%, AM Modulation
Frequency Step:	1 % of preceding frequency value
Polarity of Antenna:	Horizontal and Vertical
Antenna Height:	1.5 m
Dwell Time:	3 seconds

4.4.2 TEST INSTRUMENT

Equipment	Manufacturer	Model No.	Serial No.	Last Cal.	Next Cal.
Base station R&S CMW500	Rohde&Schwarz	CMW500	153084	Feb. 28,20	Feb. 27, 21
Audio Analyzer	Rohde&Schwarz	UPV	104035	Feb. 28,20	Feb. 27, 21
RS Test System TS9982	Rohde&Schwarz	SMB100A + SMB-B106	109279	Feb. 28,20	Feb. 27, 21
EMC32 test software	Rohde&Schwarz	EMC32	NA	NA	NA
POWER AMPLIFIER RS	Rohde&Schwarz	BBA100-B250	101805	Feb. 28,20	Feb. 27, 21
POWER AMPLIFIER RS	Rohde&Schwarz	BBA150-D110	101823	Feb. 28,20	Feb. 27, 21
RS Antenna_LF	Rohde&Schwarz	R&S® HL046E	HL064E	NA	NA
RS Antenna_HF	Rohde&Schwarz	STLP 9149	9149-329	NA	NA
3m Fully-anechoic Chamber	ETS-LINDGREN	10m*10m*5m	Euroshieldpn-CT0001143-1217	Feb. 28,20	Feb. 27, 21
Ear Simulator	Rohde&Schwarz	4182	2981654	Feb. 28,20	Feb. 27, 21
Mouth Simulator	Rohde&Schwarz	4227	2837781	NA	NA
conditioning Amplifier	Rohde&Schwarz	Type 5935	2997236	Feb. 28,20	Feb. 27, 21
power sensor	Rohde&Schwarz	NRP-Z91	102958	Aug. 26,19	Aug. 25,20
power sensor	Rohde&Schwarz	NRP-Z91	102959	Aug. 26,19	Aug. 25,20

NOTE: 1. The test was performed in RS Room.



4.4.3 TEST PROCEDURE

The test procedure was in accordance with EN 61000-4-3.

- a. The testing was performed in a fully-anechoic chamber.
- b. The frequency range is swept from 80 MHz to 6000 MHz with the signal 80% amplitude modulated with a 1 kHz sine wave.
- c. The dwell time at each frequency shall not be less than the time necessary for the EUT to be exercised and to respond, but shall in no case be less than 0.5s.
- d. The field strength level was 3 V/m.
- e. The test was performed with the EUT exposed to both vertically and horizontally polarized fields on each of the four sides.

4.4.4 DEVIATION FROM TEST STANDARD

No deviation.

4.4.5 TEST SETUP

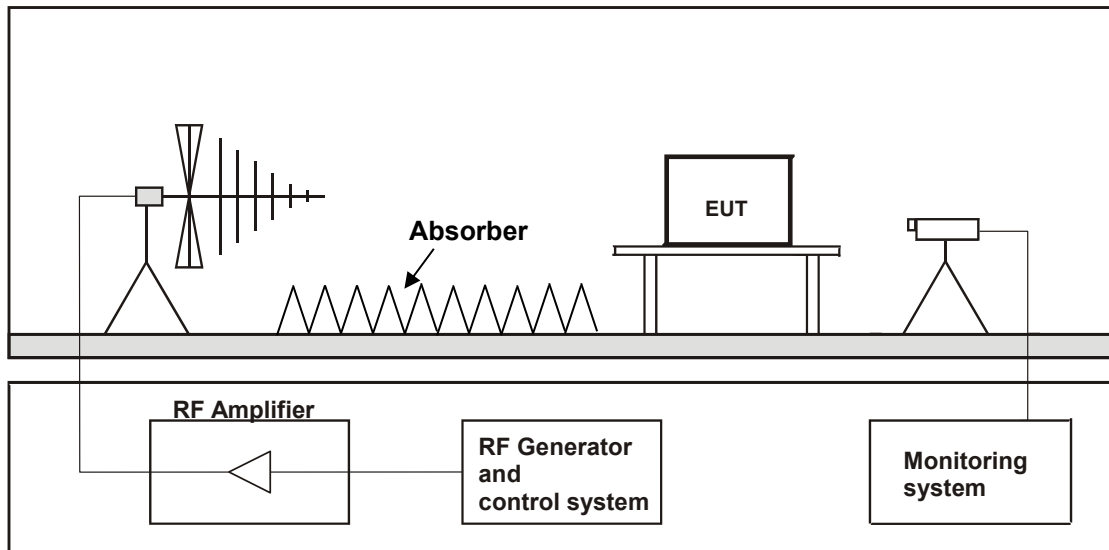

For the actual test configuration, please refer to the related item – Photographs of the Test Configuration.

NOTE:

TABLETOP EQUIPMENT

The EUT installed in a representative system as described in section 7 of EN 61000-4-3 was placed on a non-conductive table 0.8 meters in height. The system under test was connected to the power and signal wire according to relevant installation instructions.



4.4.6 TEST RESULTS

TEST VOLTAGE	Input 230 Vac, 50 Hz	ENVIRONMENTAL CONDITIONS	21.5deg. C, 50.6% RH
TEST MODE	1~4	TESTED BY	Star Le

Field Strength (V/m)	Test Frequency Note#1 (MHz)	Polarization of antenna (Horizontal / Vertical)	Azimuth (°)	Test Distance (m)	Performance Criterion	Test Result
3	80 - 6000	H&V	0/90/180/270	3	CT/CR	Complied

* The exclusion band for transmitters is 250 % of the channel width either side of the nominal operating frequency of the transmitter.

* The exclusion band for receivers shall be calculated by using the following formulae:

For the lower edge for the exclusion band: $EXband(lower) = Band_{RX}(lower) - ChW_{RX}$

For the upper edge of the exclusion band: $EXband(upper) = Band_{RX}(upper) + ChW_{RX}$

* UTRA Channel Width 5MHz

NOTE:

- For normal operating function: There was no change compared with the initial operation during and after the test.
- For the BLER Measurement: During the test, the measured BLER shall not exceed 0.01 during the test sequence.
For the BER Measurement: During the test, the measured BER shall not exceed 0.001 during the test sequence.
- Test mode 1 was the worst case of BLER and only this mode was presented in the report.
Test mode 3 was the worst case of BER and only this mode was presented in the report.



TEST VOLTAGE	Input 230 Vac, 50 Hz	ENVIRONMENTAL CONDITIONS	21.5deg. C, 50.6% RH
TEST MODE	5~11	TESTED BY	Star Le

Field Strength (V/m)	Test Frequency Note#1 (MHz)	Polarization of antenna (Horizontal / Vertical)	Azimuth (°)	Test Distance (m)	Performance Criterion	Test Result
3	80 - 6000	H&V	0/90/180/270	3	CT/CR	Complied

* The exclusion band for transmitters is 250 % of the channel width either side of the nominal operating frequency of the transmitter.

* The exclusion band for receivers shall be calculated by using the following formulae:

For the lower edge for the exclusion band: $EXband(lower) = Band_{RX}(lower) - ChW_{RX}$

For the upper edge of the exclusion band: $EXband(upper) = Band_{RX}(upper) + ChW_{RX}$

* E-UTRA Channel Width 20MHz

NOTE:

1. For normal operating function: There was no change compared with the initial operation during and after the test.
2. For throughput Measurement: During the test, the measured Throughput shall not found less than 95% of the maximum throughput of the reference measurement channel.
3. Test mode 5 was the worst case and only this mode was presented in the report.



4.4.7 DATA TRANSFER MEASUREMENT RESULTS

Worst case of the test modes:

FOR BLER

mode 1

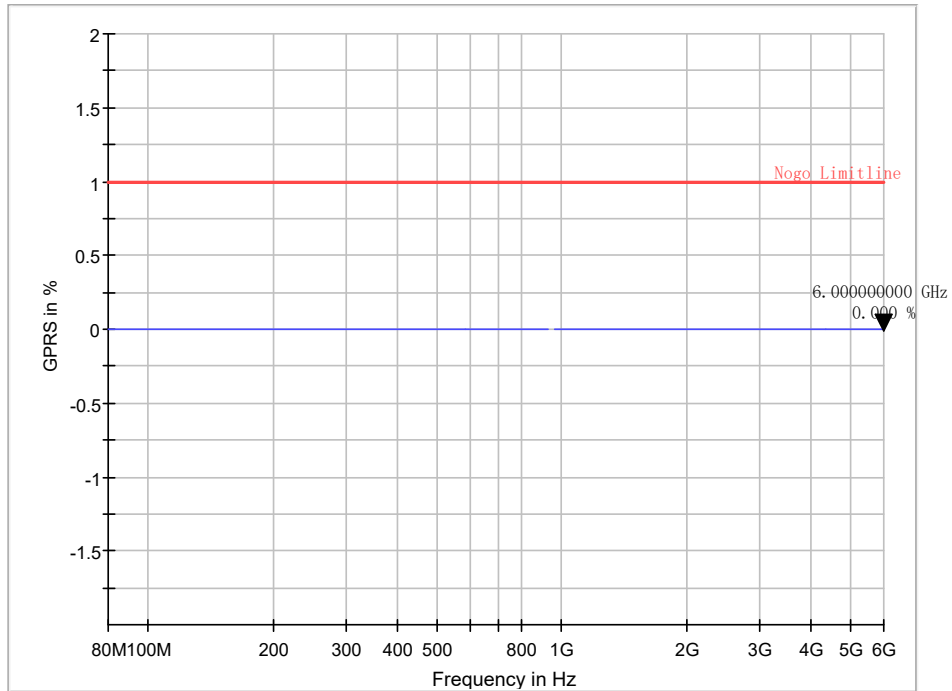



**BUREAU
VERITAS**

Test Report No.: RM200520W002

Worst case of the test modes:

For BER

Mode 3

Horizontal (0 degree)

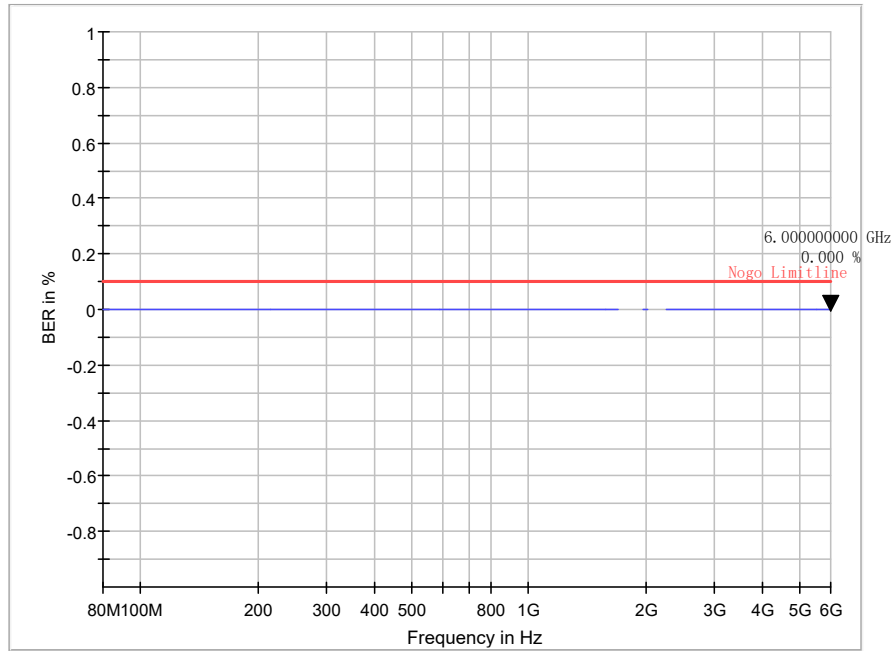



BUREAU
VERITAS

Test Report No.: RM200520W002

For Throughput
Mode 5
Horizontal (0 degree)

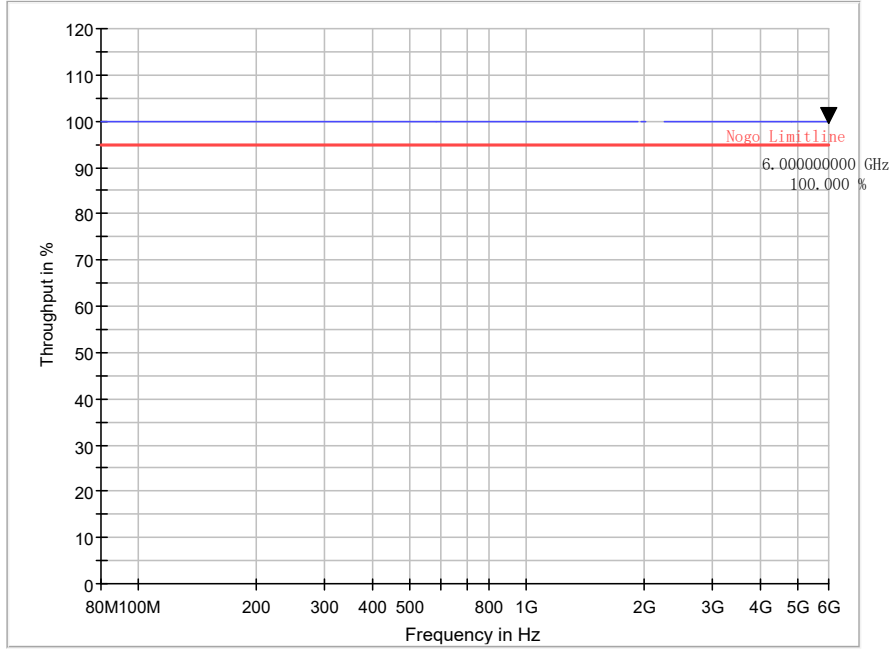



5 PHOTOGRAPHS OF THE TEST CONFIGURATION

Radiated Emission Test (Frequency range 30MHz ~1GHz)

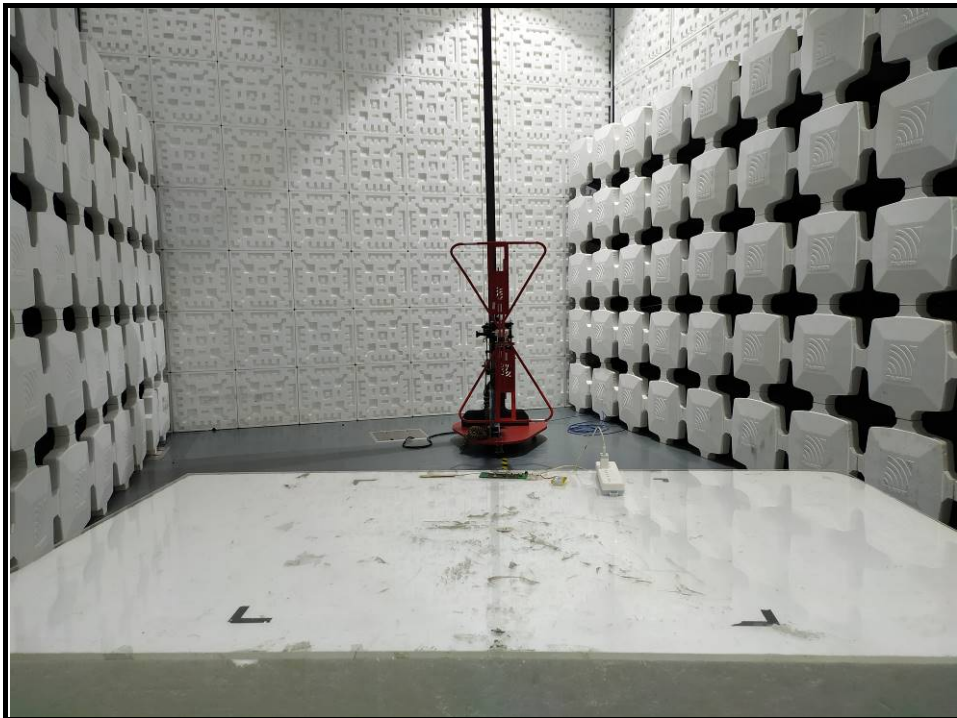
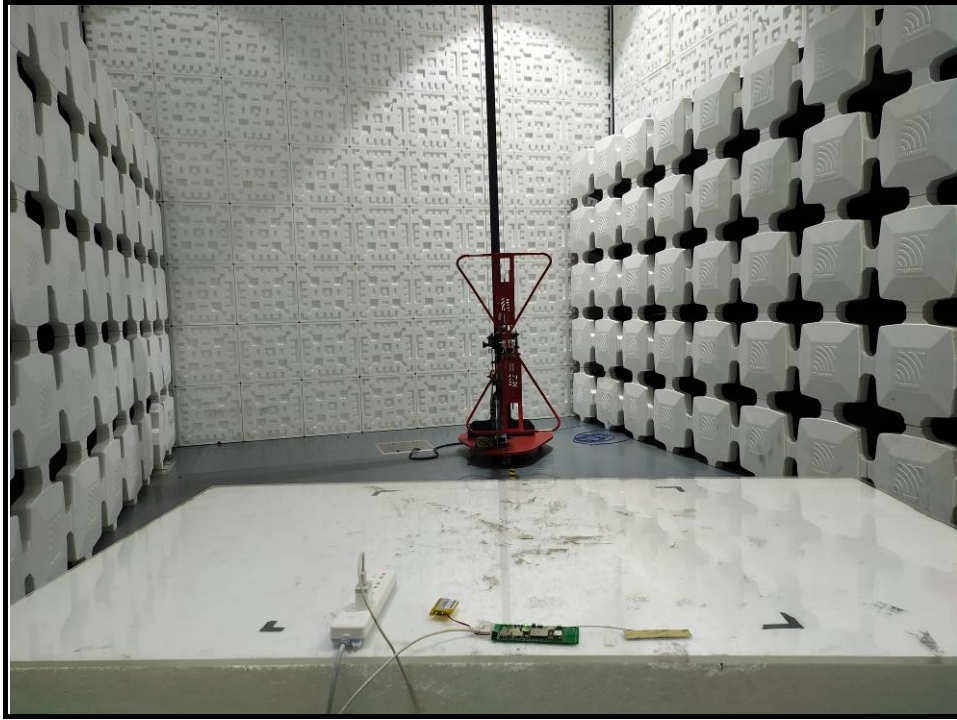

Radiated Emission Test (Frequency range above 1GHz)

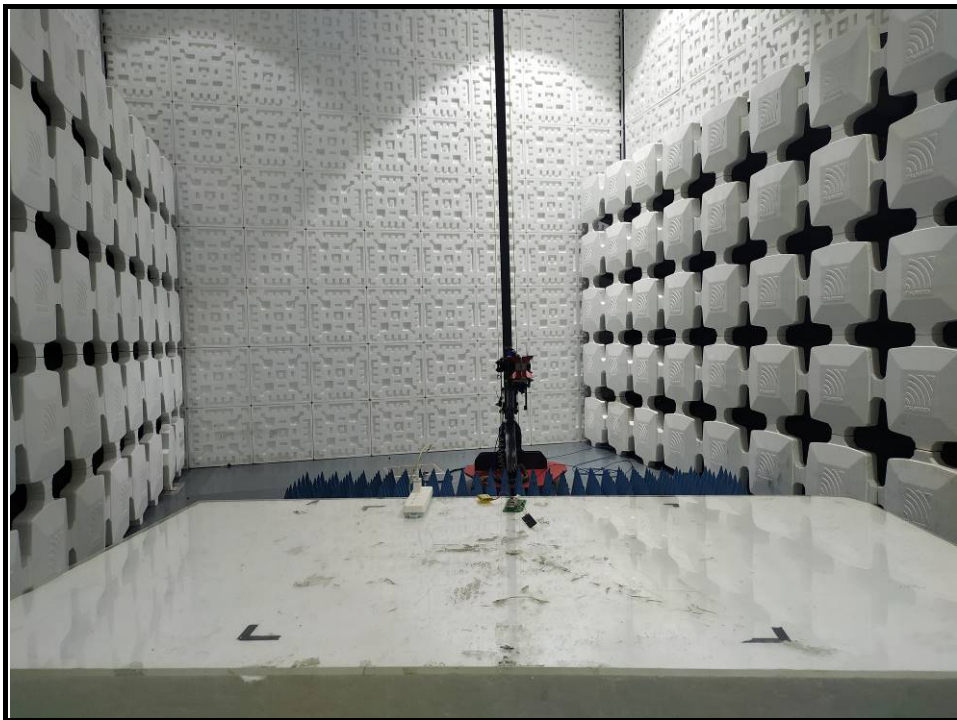
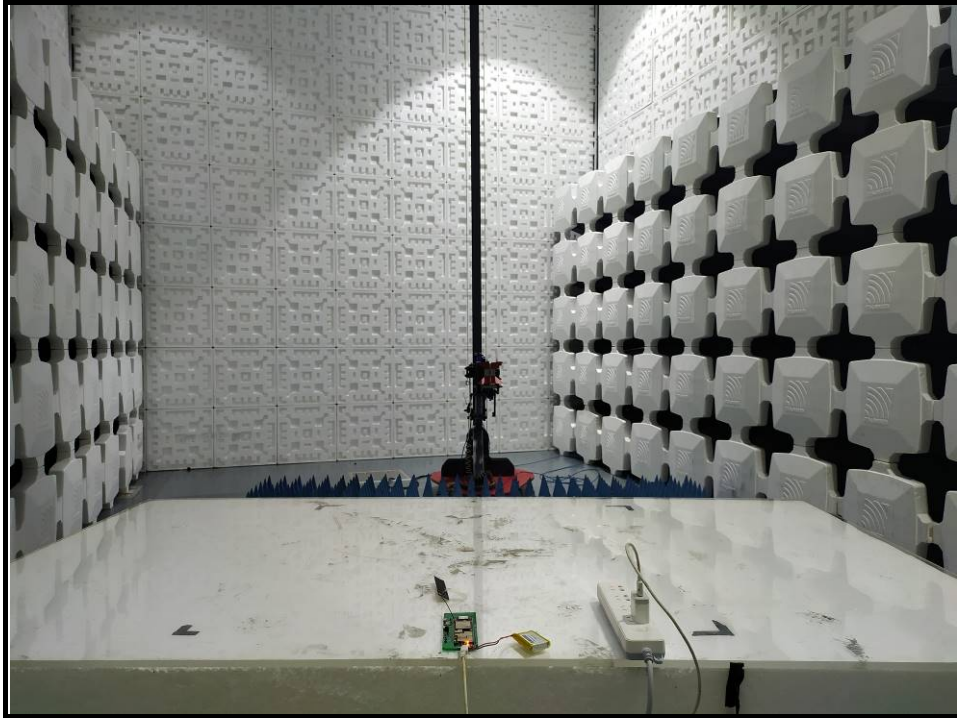

ESD Test



RS Test

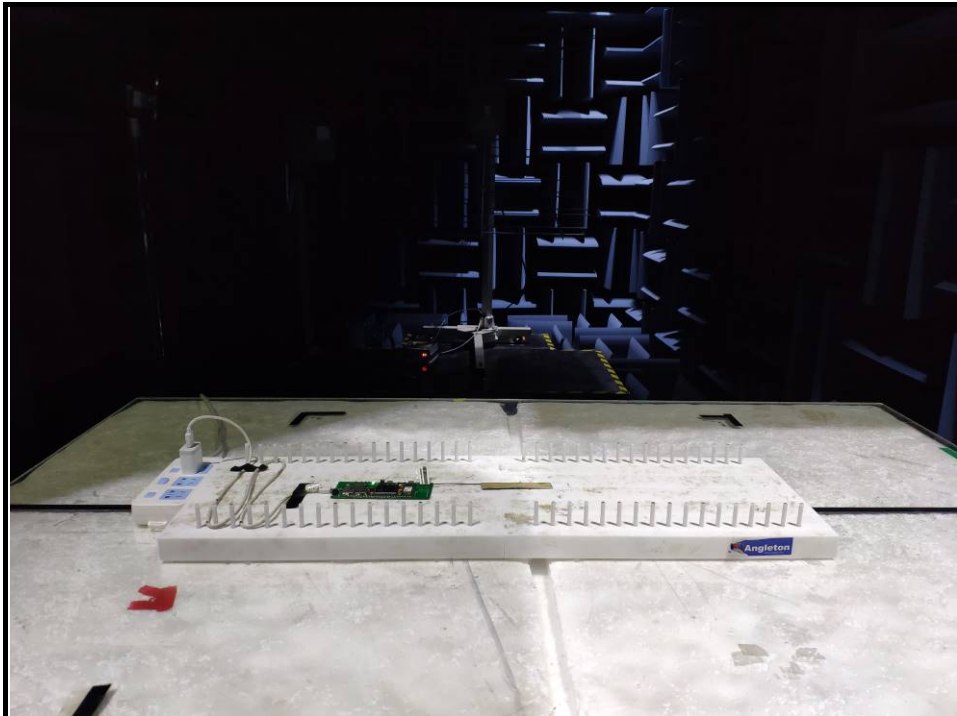



**BUREAU
VERITAS**

Test Report No.: RM200520W002

6 APPENDIX A – MODIFICATIONS RECORDERS FOR ENGINEERING CHANGES TO THE EUT BY THE LAB

No any modifications were made to the EUT by the lab during the test.

---END---