



Test Report No.: RFP20120006-3

# FCC TEST REPORT (PART 27)

Applicant:	Particle Industries, Inc
Address:	126 Post St, 4th floor, San Francisco, CA 94108 USA

Manufacturer or Supplier:	Particle Industries, Inc
Address:	126 Post St, 4th floor, San Francisco, CA 94108 USA
Product:	B Series
Brand Name:	Particle
Model Name:	B402, B404
FCC ID:	2AEMI-B402
Date of tests:	Jun. 07, 2019 ~ Jul. 10, 2019

The tests have been carried out according to the requirements of the following standard:

- FCC Part 27, Subpart C, L       ANSI/TIA/EIA-603- D
- FCC Part 2                               ANSI/TIA/EIA-603-E     ANSI C63.26-2015

**CONCLUSION:** The submitted sample was found to COMPLY with the test requirement

Prepared by Alex Chen Engineer / Mobile Department	Approved by Luke Lu Manager / Mobile Department
Date: Dec. 24, 2020	Date: Dec. 24, 2020

This report is governed by, and incorporates by reference, CPS Conditions of Service as posted at the date of issuance of this report at <http://www.bureauveritas.com/home/about-us/our-business/cps/about-us/terms-conditions> and is intended for your exclusive use. Any copying or replication of this report to or for any other person or entity, or use of our name or trademark, is permitted only with our prior written permission. This report sets forth our findings solely with respect to the test samples identified herein. The results set forth in this report are not indicative or representative of the quality or characteristics of the lot from which a test sample was taken or any similar or identical product unless specifically and expressly noted. Our report includes all of the tests requested by you and the results thereof based upon the information that you provided to us. Measurement uncertainty is only provided upon request for accredited tests. You have 60 days from date of issuance of this report to notify us of any material error or omission caused by our negligence or if you require measurement uncertainty; provided, however, that such notice shall be in writing and shall specifically address the issue you wish to raise. A failure to raise such issue within the prescribed time shall constitute your unqualified acceptance of the completeness of this report, the tests conducted and the correctness of the report contents.



# TABLE OF CONTENTS

**RELEASE CONTROL RECORD ..... 4**

**1 SUMMARY OF TEST RESULTS ..... 5**

1.1 MEASUREMENT UNCERTAINTY ..... 5

1.2 TEST SITE AND INSTRUMENTS ..... 6

**2 GENERAL INFORMATION..... 7**

2.1 GENERAL DESCRIPTION OF EUT ..... 7

2.2 CONFIGURATION OF SYSTEM UNDER TEST ..... 8

2.3 DESCRIPTION OF SUPPORT UNITS ..... 9

2.4 DESCRIPTION OF TEST MODES..... 9

2.5 GENERAL DESCRIPTION OF APPLIED STANDARDS ..... 11

**3 TEST TYPES AND RESULTS ..... 12**

3.1 OUTPUT POWER MEASUREMENT ..... 12

3.1.1 LIMITS OF OUTPUT POWER MEASUREMENT ..... 12

3.1.2 TEST PROCEDURES ..... 12

3.1.3 TEST SETUP ..... 13

3.1.4 TEST RESULTS ..... 14

3.2 FREQUENCY STABILITY MEASUREMENT ..... 18

3.2.1 LIMITS OF FREQUENCY STABILITY MEASUREMENT ..... 18

3.2.2 TEST PROCEDURE ..... 18

3.2.3 TEST SETUP ..... 18

3.2.4 TEST RESULTS ..... 18

3.3 OCCUPIED BANDWIDTH MEASUREMENT ..... 18

3.3.1 LIMITS OF OCCUPIED BANDWIDTH MEASUREMENT ..... 19

3.3.2 TEST SETUP ..... 19

3.3.3 TEST PROCEDURES ..... 19

3.3.4 TEST RESULTS ..... 19

3.4 PEAK TO AVERAGE RATIO ..... 20

3.4.1 LIMITS OF PEAK TO AVERAGE RATIO MEASUREMENT ..... 20

3.4.2 TEST SETUP ..... 20

3.4.3 TEST PROCEDURES ..... 20

3.4.4 TEST RESULTS ..... 20

3.5 BAND EDGE MEASUREMENT ..... 21

3.5.1 LIMITS OF BAND EDGE MEASUREMENT ..... 21

3.5.2 TEST SETUP ..... 21

3.5.3 TEST PROCEDURES ..... 22

3.5.4 TEST RESULTS ..... 22

3.6 CONDUCTED SPURIOUS EMISSIONS..... 23

3.6.1 LIMITS OF CONDUCTED SPURIOUS EMISSIONS MEASUREMENT ..... 23

3.6.2 TEST PROCEDURE ..... 23

3.6.3 TEST SETUP ..... 23

3.6.4 TEST RESULTS ..... 23

3.7 RADIATED EMISSION MEASUREMENT ..... 24

3.7.1 LIMITS OF RADIATED EMISSION MEASUREMENT ..... 24

3.7.2 TEST PROCEDURES ..... 24

3.7.3 DEVIATION FROM TEST STANDARD ..... 24

3.7.4 TEST SETUP ..... 25

3.7.5 TEST RESULTS ..... 26



**BUREAU  
VERITAS**

**Test Report No.: RFP20120006-3**

<b>4</b>	<b>INFORMATION ON THE TESTING LABORATORIES .....</b>	<b>46</b>
<b>5</b>	<b>APPENDIX A – MODIFICATIONS RECORDERS FOR ENGINEERING CHANGES TO THE EUT BY THE LAB .....</b>	<b>47</b>



Test Report No.: RFP20120006-3

## RELEASE CONTROL RECORD

ISSUE NO.	REASON FOR CHANGE	DATE ISSUED
RF190606W003-3	Original release	Jul. 19, 2019
RFP20120006-3	Based on the original report RF190606W003-3 change the product name and models, which not affect RF function. So all the test data re-use from RF190606W003-3.	Dec. 24, 2020

## 1 SUMMARY OF TEST RESULTS

The EUT has been tested according to the following specifications:

APPLIED STANDARD: FCC Part 27 & Part 2			
STANDARD SECTION	TEST TYPE AND LIMIT	RESULT	REMARK
2.1046 27.50(d)(4)	Maximum Peak Output Power	PASS	Meet the requirement of limit.
2.1055 27.54	Frequency Stability	N/A(see note)	Meet the requirement of limit.
2.1049 27.53(h)	Occupied Bandwidth	N/A(see note)	Meet the requirement of limit.
27.50(d)(5)	Peak to average ratio	N/A(see note)	Meet the requirement of limit.
27.53(h)	Band Edge Measurements	N/A(see note)	Meet the requirement of limit.
2.1051 27.53(h)	Conducted Spurious Emissions	N/A(see note)	Meet the requirement of limit.
2.1053 27.53(h)	Radiated Spurious Emissions	PASS	Meet the requirement of limit. Minimum passing margin is -14.49dB at 1572.000MHz.

Note: more detail please refer to the original report RF190606W003-3

\* Refer to KDB 971168 D01 Power Meas License Digital Systems v03r01

### 1.1 MEASUREMENT UNCERTAINTY

Where relevant, the following measurement uncertainty levels have been estimated for tests performed on the EUT as specified in CISPR 16-4-2:

MEASUREMENT	FREQUENCY	UNCERTAINTY
Conducted emissions	9kHz~30MHz	2.66dB
Radiated emissions	9KHz ~ 30MHz	2.68dB
	30MHz ~ 1GMHz	3.26dB
	1GHz ~ 18GHz	4.48dB
	18GHz ~ 40GHz	4.12dB

This uncertainty represents an expanded uncertainty expressed at approximately the 95% confidence level using a coverage factor of k=2.

## 1.2 TEST SITE AND INSTRUMENTS

Equipment	Manufacturer	Model No.	Serial No.	Last Cal.	Next Cal.
MXE EMI Receiver	KEYSIGHT	N9038A-544	MY54450026	Feb. 26,19	Feb. 25,20
EXA Signal Analyzer	KEYSIGHT	N9010A-526	MY54510322	Feb. 26,19	Feb. 25,20
Bilog Antenna 1	ETS-LINDGREN	3143B	00161964	Feb. 26,19	Feb. 25,20
Bilog Antenna 2	ETS-LINDGREN	3143B	00161965	Feb. 26,19	Feb. 25,20
Horn Antenna 1	ETS-LINDGREN	3117	00168728	Feb. 26,19	Feb. 25,20
Horn Antenna 2	ETS-LINDGREN	3117	00168692	Nov. 30, 18	Nov. 29, 19
Horn Antenna (18GHz-40GHz)	N/A	QWH-SL-18-40 -K-SG/QMS-00 361	15433	Nov. 21, 18	Nov. 20, 19
Radio Communication Analyzer	ANRITSU	MT8820C	6201465426	Feb. 26,19	Feb. 25,20
Signal Pre-Amplifier	EMSI	EMC 9135	980249	Jul. 09,19	Jul. 08,20
Signal Pre-Amplifier	EMSI	EMC 012645B	980257	Jul. 09,19	Jul. 08,20
Signal Pre-Amplifier	EMSI	EMC 184045B	980259	Jul. 09,19	Jul. 08,20
3m Semi-anechoic Chamber	ETS-LINDGREN	9m*6m*6m	Euroshieldpn- CT0001143-1216	Feb. 26,19	Feb. 25,20
Test Software	E3	V 9.160323	N/A	N/A	N/A
Test Software	ADT	ADT_Radiated _V7.6.15.9.2	N/A	N/A	N/A
10dB Attenuator	JFW/USA	50HF-010-SM A	1505	Jul. 09,19	Jul. 08,20
Power Meter	Anritsu	ML2495A	1506002	Feb. 26,19	Feb. 25,20
Power Sensor	Anritsu	MA2411B	1339352	Feb. 26,19	Feb. 25,20
Humid & Temp Programmable Tester	Juyi	ITH-120-45-CP -AR	IAA1504-001	Jul. 09,19	Jul. 08,20
MXG Analog Microvave Signal Generator	KEYSIGHT	N5183A	MY50143024	Feb. 26,19	Feb. 25,20

- NOTE:**
1. The calibration interval of the above test instruments is 12 months or 24 months and the calibrations are traceable to CEPREI/CHINA, GRGT/CHINA and NIM/CHINA.
  2. The test was performed in 3m Semi-anechoic Chamber and RF Oven Room.
  3. The horn antenna is used only for the measurement of emission frequency above 1GHz if tested.
  4. The FCC Site Registration No. is 525120; The Designation No. is CN1171.

## 2 GENERAL INFORMATION

### 2.1 GENERAL DESCRIPTION OF EUT

<b>PRODUCT</b>	B Series	
<b>MODEL NAME</b>	B402, B404	
<b>POWER SUPPLY</b>	3.8Vdc (Li-ion, battery)	
<b>MODULATION TECHNOLOGY</b>	LTE	QPSK, 16QAM
<b>FREQUENCY RANGE</b>	LTE Band 4 Channel Bandwidth: 1.4MHz	1710.7MHz ~ 1754.3MHz
	LTE Band 12 Channel Bandwidth: 1.4MHz	699.7MHz ~ 715.3MHz
	LTE Band 13 Channel Bandwidth: 1.4MHz	777.7MHz ~ 786.3MHz
<b>EMISSION DESIGNATOR</b>	LTE Band 4	QPSK: 1M24G7D 16QAM: 1M13W7D
	LTE Band 12	QPSK: 1M11G7D 16QAM: 1M11W7D
	LTE Band 13	QPSK: 1M13G7D 16QAM: 1M21W7D
<b>MAX. ERP/EIRP POWER</b>	LTE Band 4 Channel Bandwidth: 1.4MHz	276mW
	LTE Band 12 Channel Bandwidth: 1.4MHz	168mW
	LTE Band 13 Channel Bandwidth: 1.4MHz	222mW
<b>ANTENNA TYPE</b>	LTE Band 4	Fixed External Antenna with 3.5dBi
	LTE Band 12/ LTE Band 13	Fixed External Antenna with 1dBi
<b>HW VERSION</b>	V1.00	
<b>SW VERSION</b>	V1.2.1	
<b>ACCESSORY DEVICE</b>	Refer to user's manual	
<b>DATA CABLE</b>	N/A	

**NOTE:**

1. For a more detailed features description, please refer to the manufacturer's specifications or the user's manual.
2. For the test results, the EUT had been tested with all conditions. But only the worst case was shown in test report.
3. The differences of B402 and B404 are as follow: B402 uses eSIM of Kore.B404 uses eSIM of Twilio.

## 2.2 CONFIGURATION OF SYSTEM UNDER TEST

### FOR RADIATION EMISSION TEST

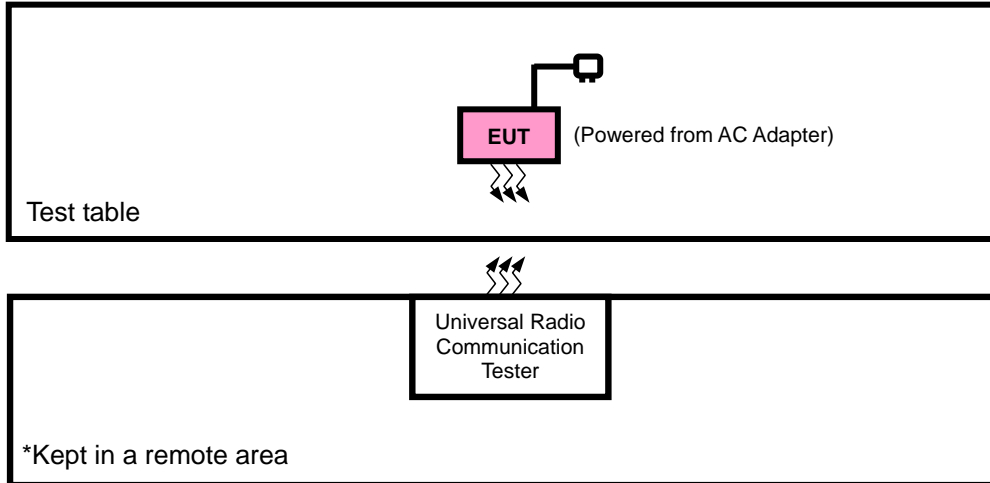

### FOR CONDUCTED & E.R.P./E.I.R.P TEST

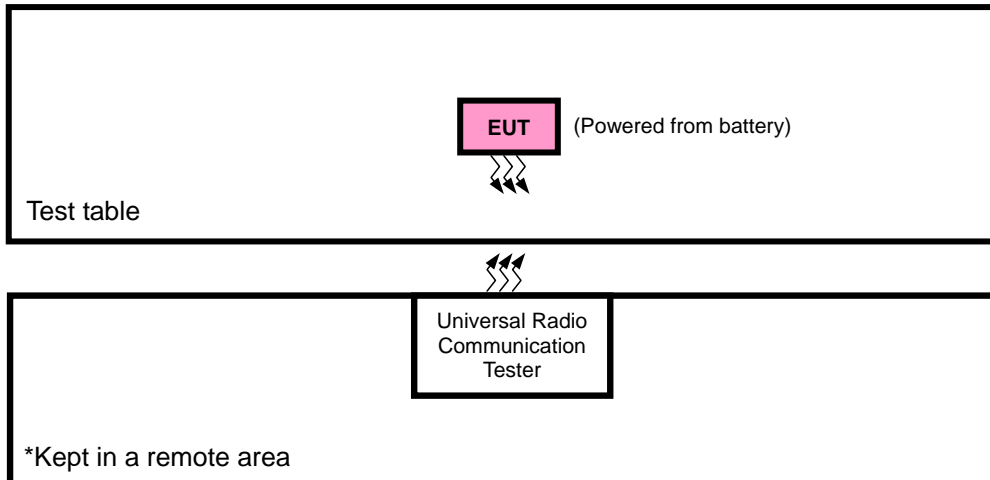



## 2.3 DESCRIPTION OF SUPPORT UNITS

The EUT has been tested as an independent unit together with other necessary accessories or support units. The following support units or accessories were used to form a representative test configuration during the tests.

NO.	PRODUCT	BRAND	MODEL NO.	SERIAL NO.	FCC ID
1	DC source	LONG WEI	PS-6403D	010934269	N/A
2	PC	HP	A6608CN	3CR83825X3	N/A
3	USB	N/A	N/A	N/A	N/A
4	Battery	N/A	N/A	N/A	N/A

NO.	SIGNAL CABLE DESCRIPTION OF THE ABOVE SUPPORT UNITS
1	DC Line: Unshielded, Detachable 1.0m
2	AC Line: Unshielded, Detachable 1.5m
3	N/A
4	N/A
5	N/A

**NOTE:**

1. All power cords of the above support units are non shielded (1.8m).

## 2.4 DESCRIPTION OF TEST MODES

Pre-Scan has been conducted to determine the worst-case mode from all possible combinations between available modulations, data rates, XYZ axis and antenna ports. The worst case in ERP/EIRP and radiated emission was found when positioned on X-plane for LTE. Following channel(s) was (were) selected for the final test as listed below:

EUT CONFIGURE MODE	DESCRIPTION
-	EUT + Battery with LTE link

#### LTE BAND 4

EUT CONFIGURE MODE	TEST ITEM	AVAILABLE CHANNEL	TESTED CHANNEL	CHANNEL BANDWIDTH	MODULATION	MODE
-	EIRP	19957 to 20393	19957, 20175, 20393	1.4MHz	QPSK, 16QAM	1 RB / 0 RB Offset
-	RADIATED EMISSION	19957 to 20393	19957, 20175, 20393	1.4MHz	QPSK	1 RB / 0 RB Offset

**Note:** This device was tested under all bandwidths, RB configurations and modulations. The worst case was found in QPSK modulation.

#### LTE BAND 12

EUT CONFIGURE MODE	TEST ITEM	AVAILABLE CHANNEL	TESTED CHANNEL	CHANNEL BANDWIDTH	MODULATION	MODE
-	ERP	23017 to 23173	23017, 23095 , 23173	1.4MHz	QPSK,16QAM	1 RB / 0 RB Offset
-	RADIATED EMISSION	23017 to 23173	23017, 23095 , 23173	1.4MHz	QPSK	1 RB / 0 RB Offset

**Note:** This device was tested under all bandwidths, RB configurations and modulations. The worst case was found in QPSK modulation.

#### LTE BAND 13

EUT CONFIGURE MODE	TEST ITEM	AVAILABLE CHANNEL	TESTED CHANNEL	CHANNEL BANDWIDTH	MODULATION	MODE
-	ERP	23187 to 23273	23187, 23230, 23273	1.4MHz	QPSK, 16QAM	1 RB / 0 RB Offset
-	RADIATED EMISSION	23187 to 23273	23187, 23230, 23273	1.4MHz	QPSK	1 RB / 0 RB Offset

**Note:** This device was tested under all bandwidths, RB configurations and modulations. The worst case was found in QPSK modulation.

#### TEST CONDITION:

TEST ITEM	ENVIRONMENTAL CONDITIONS	INPUT POWER	TESTED BY
EIRP(ERP)	24deg. C, 60%RH	3.8Vdc from Battery	Star Le
RADIATED EMISSION	24deg. C, 60%RH	3.8Vdc from Battery	Star Le



Test Report No.: RFP20120006-3

## 2.5 GENERAL DESCRIPTION OF APPLIED STANDARDS

The EUT is a RF product. According to the specifications of the manufacturer, it must comply with the requirements of the following standards:

**FCC 47 CFR Part 2**

**FCC 47 CFR Part 27**

**KDB 971168 D01 Power Meas License Digital Systems v03r01**

**ANSI/TIA/EIA-603-D**

**ANSI/TIA/EIA-603-E**

**ANSI C63.26-2015**

**NOTE:** All test items have been performed and recorded as per the above standards.



### 3 TEST TYPES AND RESULTS

#### 3.1 OUTPUT POWER MEASUREMENT

##### 3.1.1 LIMITS OF OUTPUT POWER MEASUREMENT

Fixed, mobile, and portable (hand-held) stations operating in the 1710–1755 MHz band are limited to 1 watt EIRP.

Portable stations (hand-held devices) operating in the 699-716 MHz bands are limited to 3 watts ERP.

##### 3.1.2 TEST PROCEDURES

###### EIRP / ERP MEASUREMENT:

- a. The EUT was set up for the maximum power with LTE link data modulation. The power was measured with R&S Spectrum Analyzer. All measurements were done at 3 channels (low, middle and high operational frequency range). RBW and VBW is 10MHz for LTE.
- b. E.I.R.P power measurement. In the semi-anechoic chamber, EUT placed on the 0.8m height of Turn Table, rotated the table around 360 degrees to search the maximum radiation power and receiver antenna shall be rotated vertical and horizontal polarization and moved height from 1m to 4m to find the maximum polar radiated power. The “Read Value” is the spectrum reading the maximum power value.
- c. The substitution horn antenna is substituted for EUT at the same position and signals generator export the CW signal to the substitution antenna via a TX cable. Rotated the Turn Table and moved receiving antenna to find the maximum radiation power. Adjust output power level of S.G to get a Value of spectrum reading equal to “Read Value” of step a. Record the power level of S.G
- d.  $EIRP = \text{Output power level of S.G} - \text{TX cable loss} + \text{Antenna gain of substitution horn}$
- e.  $E.R.P = E.I.R.P - 2.15 \text{ dB}$

###### CONDUCTED POWER MEASUREMENT:

- a. The EUT was set up for the maximum power with LTE link data modulation and link up with simulator.
- b. Set the EUT to transmit under low, middle and high channel and record the power level shown on simulator.

### 3.1.3 TEST SETUP

EIRP / ERP Measurement:

<Radiated Emission below or equal 1 GHz>

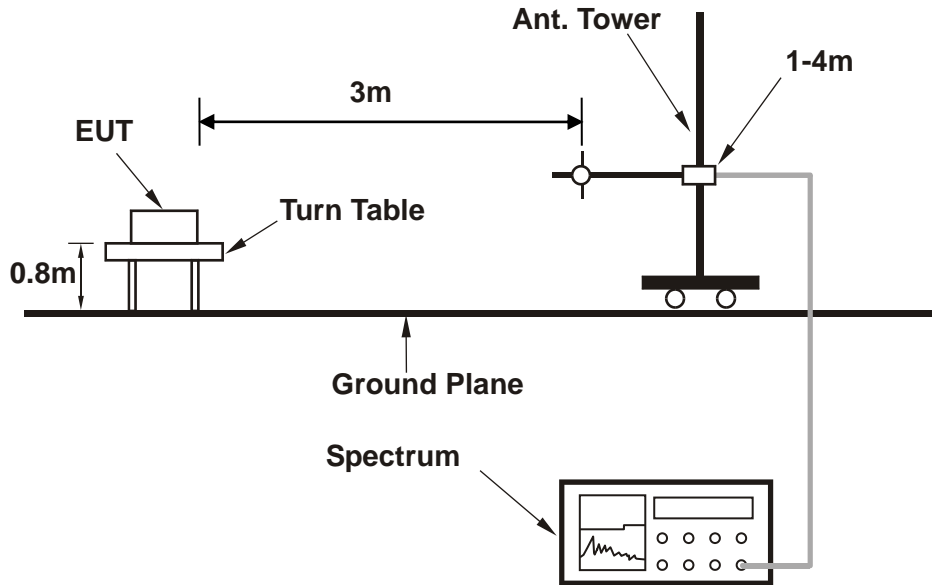

<Radiated Emission above 1 GHz>

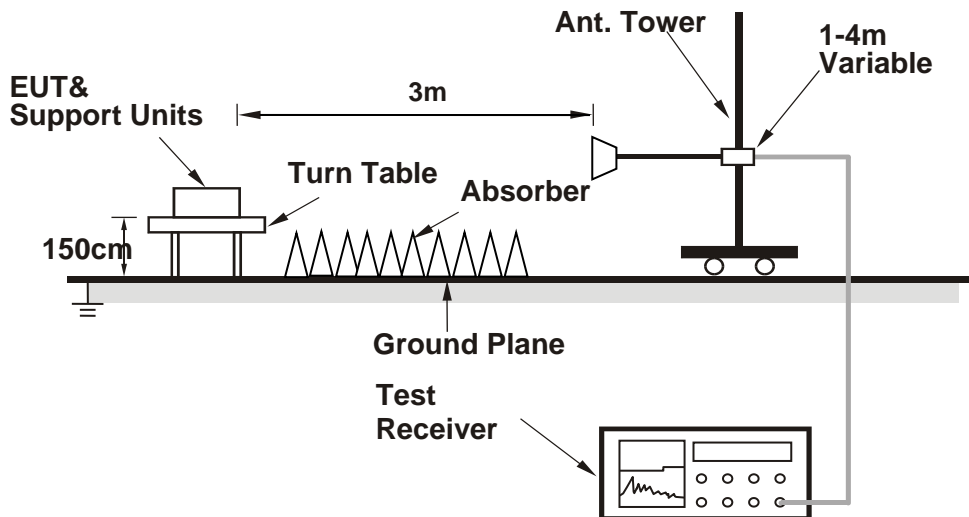

For the actual test configuration, please refer to the attached file (Test Setup Photo).

**CONDUCTED POWER MEASUREMENT:**

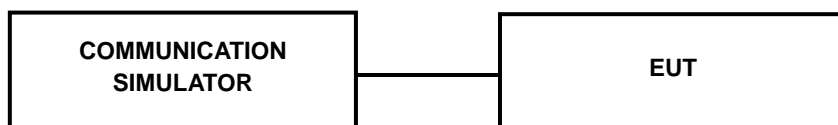

### 3.1.4 TEST RESULTS

#### AVERAGE CONDUCTED OUTPUT POWER (dBm)

Base on verify the Conducted Power is the same with module test report (SD72132148-1017A REV.1) by lab, the test results please refer the module Report No.: SD72132148-1017A REV.1, and the pre-scan data as below.

LTE Band 4				
modulation	bandwidth	channels	Frequency	Tx Average (dBm)
QPSK	1.4 MHz	19957	1710.7	23.77
		20175	1732.5	23.72
		20393	1754.3	23.40
16QAM	1.4 MHz	19957	1710.7	23.78
		20175	1732.5	23.74
		20393	1754.3	23.41

LTE Band 12				
modulation	bandwidth	channels	Frequency	Tx Average (dBm)
QPSK	1.4 MHz	23017	699.7	23.28
		23095	707.5	23.66
		23173	715.3	23.87
16QAM	1.4 MHz	23017	699.7	23.35
		23095	707.5	23.67
		23173	715.3	24.14

LTE Band 13				
modulation	bandwidth	channels	Frequency	Tx Average (dBm)
QPSK	1.4 MHz	23187	777.7	24.28
		23230	782.0	24.27
		23273	786.3	24.17
16QAM	1.4 MHz	23187	777.7	24.36
		23230	782.0	24.11
		23273	786.3	24.13



**BUREAU  
VERITAS**

Test Report No.: RFP20120006-3

**EIRP**

**LTE BAND 4**

**CHANNEL BANDWIDTH: 1.4MHz QPSK**

Channel	Frequency (MHz)	SPA LVL (dBm)	Correction Factor(dB)	EIRP(dBm)	EIRP(mW)	Polarization (H/V)	LIMIT (W)
19957	1710.7	-19.12	41.29	22.17	164.97	H	1
20175	1732.5	-18.74	41.36	22.62	182.81	H	1
20393	1754.3	-18.33	42.74	24.41	<b>275.93</b>	H	1
19957	1710.7	-22.71	44.25	21.54	142.40	V	1
20175	1732.5	-22.02	44.20	22.18	165.20	V	1
20393	1754.3	-22.44	44.09	21.65	146.05	V	1

**CHANNEL BANDWIDTH: 1.4MHz 16QAM**

Channel	Frequency (MHz)	SPA LVL (dBm)	Correction Factor(dB)	EIRP(dBm)	EIRP(mW)	Polarization (H/V)	LIMIT (W)
19957	1710.7	-19.99	41.29	21.30	135.02	H	1
20175	1732.5	-19.67	41.36	21.69	147.57	H	1
20393	1754.3	-19.29	42.74	23.45	221.21	H	1
19957	1710.7	-23.58	44.25	20.67	116.55	V	1
20175	1732.5	-22.95	44.20	21.25	133.35	V	1
20393	1754.3	-23.40	44.09	20.69	117.08	V	1

- REMARKS:** 1. EIRP Output Power (dBm) = SPA LVL (dBm) + Correction Factor (dB).  
2. Correction factor (dB) = Free Space Loss + Antenna Factor + Cable Loss

**LTE BAND 12**

**CHANNEL BANDWIDTH: 1.4MHz QPSK**

Channel	Frequency (MHz)	SPA LVL (dBm)	Correction Factor(dB)	ERP(dBm)	ERP(mW)	Polarization (H/V)	LIMIT (W)
23017	699.7	-9.96	32.77	20.66	116.41	H	3
23095	707.5	-8.82	33.23	22.26	<b>168.27</b>	H	3
23173	715.3	-9.35	33.14	21.64	145.81	H	3
23017	699.7	-20.18	32.42	10.09	10.20	V	3
23095	707.5	-19.60	32.60	10.85	12.16	V	3
23173	715.3	-20.63	32.19	9.41	8.72	V	3

**CHANNEL BANDWIDTH: 1.4MHz 16QAM**

Channel	Frequency (MHz)	SPA LVL (dBm)	Correction Factor(dB)	ERP(dBm)	ERP(mW)	Polarization (H/V)	LIMIT (W)
23017	699.7	-10.79	32.77	19.83	96.16	H	3
23095	707.5	-9.84	33.23	21.24	133.05	H	3
23173	715.3	-10.45	33.14	20.54	113.19	H	3
23017	699.7	-21.01	32.42	9.26	8.43	V	3
23095	707.5	-20.62	32.60	9.83	9.62	V	3
23173	715.3	-21.73	32.19	8.31	6.77	V	3

- REMARKS:** 1. ERP Output Power (dBm) = SPA LVL (dBm) + Correction Factor (dB) -2.15(dB).  
 2. Correction factor (dB) = Free Space Loss + Antenna Factor + Cable Loss





Test Report No.: RFP20120006-3

### LTE BAND 13

#### CHANNEL BANDWIDTH: 1.4MHz QPSK

Channel	Frequency (MHz)	SPA LVL (dBm)	Correction Factor(dB)	ERP(dBm)	ERP(mW)	Polarization (H/V)	LIMIT (W)
23187	777.7	-7.72	32.60	22.73	187.50	H	3
23230	782.0	-7.14	32.75	23.46	<b>221.82</b>	H	3
23273	786.3	-7.48	33.08	23.45	221.31	H	3
23187	777.7	-18.35	31.54	11.04	12.71	V	3
23230	782.0	-18.39	31.70	11.16	13.06	V	3
23273	786.3	-17.88	31.97	11.94	15.63	V	3

#### CHANNEL BANDWIDTH: 1.4MHz 16QAM

Channel	Frequency (MHz)	SPA LVL (dBm)	Correction Factor(dB)	ERP(dBm)	ERP(mW)	Polarization (H/V)	LIMIT (W)
23187	777.7	-8.08	32.60	22.37	172.58	H	3
23230	782.0	-7.62	32.75	22.98	198.61	H	3
23273	786.3	-7.98	33.08	22.95	197.24	H	3
23187	777.7	-18.55	31.54	10.84	12.13	V	3
23230	782.0	-18.98	31.70	10.57	11.40	V	3
23273	786.3	-19.02	31.97	10.80	12.02	V	3

**REMARKS:** 1. ERP Output Power (dBm) = SPA LVL (dBm) + Correction Factor (dB) -2.15(dB).  
2. Correction factor (dB) = Free Space Loss + Antenna Factor + Cable Loss

## 3.2 FREQUENCY STABILITY MEASUREMENT

### 3.2.1 LIMITS OF FREQUENCY STABILITY MEASUREMENT

The frequency stability shall be sufficient to ensure that the fundamental emissions stay within the authorized bands of operation.

### 3.2.2 TEST PROCEDURE

- a. Device is placed at the oven room. The oven room could control the temperatures and humidity. Power warm up is at least 15 min and power applied should perform before recording frequency error.
- b. EUT is connected the external power supply to control the DC input power. The test voltage range is from minimum to maximum working voltage. Each step shall be record the frequency error rate.
- c. The temperature range step is 10 degrees in this test items. All temperature levels shall be hold the  $\pm 0.5^{\circ}\text{C}$  during the measurement testing. The each temperature step shall be at least 0.5 hours, consider the EUT could be test under the stability condition.

**NOTE:** The frequency error was recorded frequency error from the communication simulator.

### 3.2.3 TEST SETUP

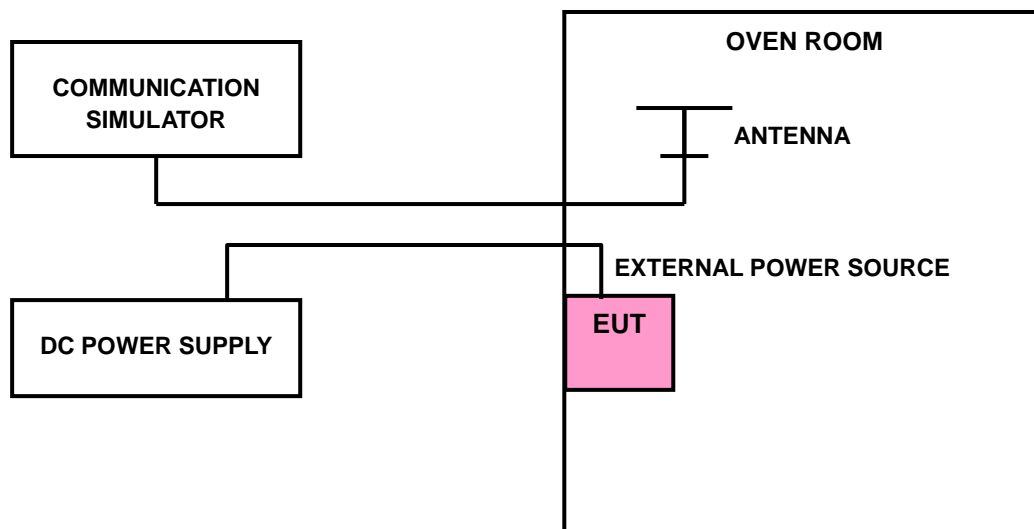

### 3.2.4 TEST RESULTS

The test results please refer the module Reports No.:SD72132148-1017A REV.1.

### 3.3 OCCUPIED BANDWIDTH MEASUREMENT

#### 3.3.1 LIMITS OF OCCUPIED BANDWIDTH MEASUREMENT

The width of a frequency band such that, below the lower and above the upper frequency limits, the mean powers emitted are each equal to a specified percentage 0.5 %of the total mean power of a given emission.

#### 3.3.2 TEST SETUP

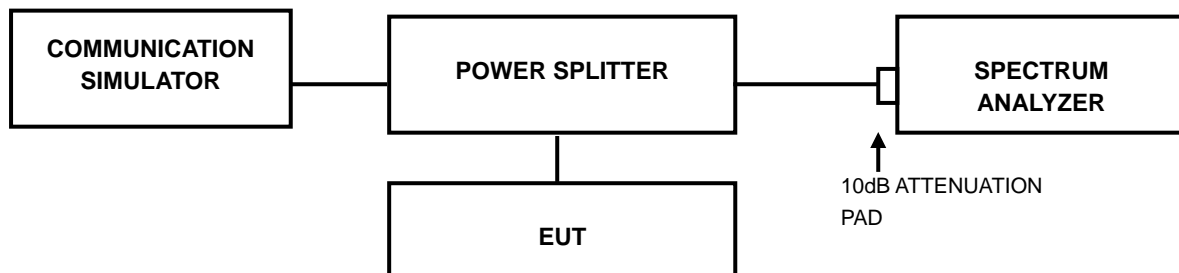

#### 3.3.3 TEST PROCEDURES

- The conducted occupied bandwidth used the power splitter via EUT RF power connector between simulation base station and spectrum analyzer.
- Use OBW measurement function of Spectrum analyzer to measure 99 % occupied bandwidth.

#### 3.3.4 TEST RESULTS

The test results please refer the module Reports No.:SD72132148-1017A REV.1.

### 3.4 PEAK TO AVERAGE RATIO

#### 3.4.1 LIMITS OF PEAK TO AVERAGE RATIO MEASUREMENT

In measuring transmissions in this band using an average power technique, the peak to-average ratio (PAR) of the transmission may not exceed 13 dB

#### 3.4.2 TEST SETUP

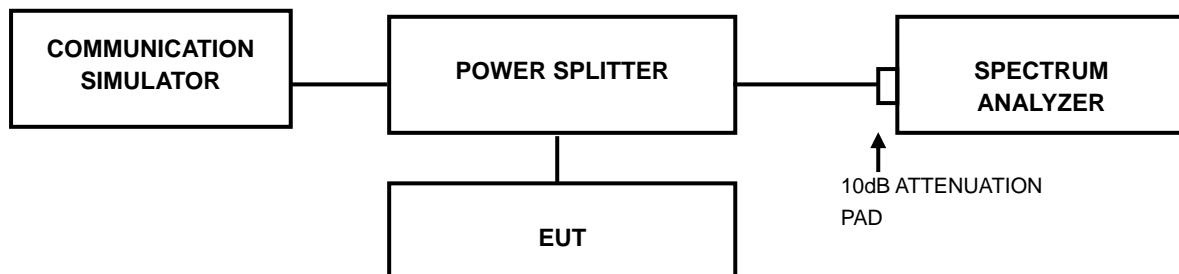

#### 3.4.3 TEST PROCEDURES

1. Set resolution/measurement bandwidth  $\geq$  signal's occupied bandwidth;
2. Set the number of counts to a value that stabilizes the measured CCDF curve;
3. Record the maximum PAPR level associated with a probability of 0.1%.

#### 3.4.4 TEST RESULTS

The test results please refer the module Reports No.:SD72132148-1017A REV.1.

### 3.5 BAND EDGE MEASUREMENT

#### 3.5.1 LIMITS OF BAND EDGE MEASUREMENT

The power of any emission outside a licensee's frequency band(s) of operation shall be attenuated below the transmitter power (P) within the licensed band(s) of operation, measured in watts, by at least  $43 + 10 \log (P)$  dB. Compliance with this provision is based on the use of measurement instrumentation employing a resolution bandwidth of 100 kilohertz or greater.

However, in the 100 kilohertz bands immediately outside and adjacent to a licensee's frequency block, a resolution bandwidth of at least 30 kHz may be employed.

#### 3.5.2 TEST SETUP

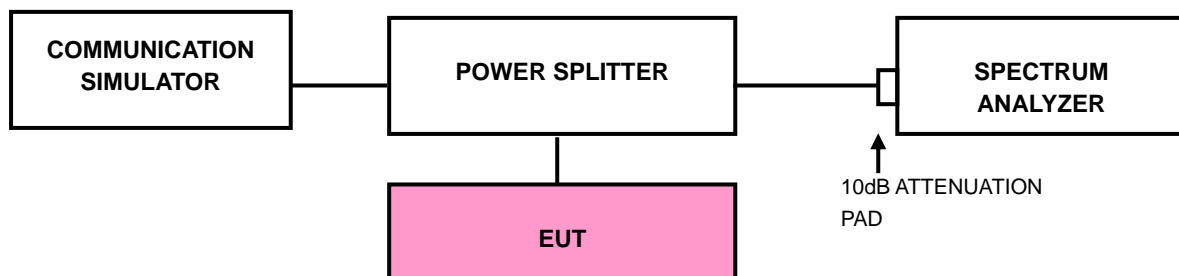



Test Report No.: RFP20120006-3

### 3.5.3 TEST PROCEDURES

- a. The EUT was set up for the maximum peak power with LTE link data modulation. The power was measured with R&S Spectrum Analyzer. All measurements were done at 2 channels (low and high operational frequency range.).
- b. The band edge measurement used the power splitter via EUT RF power connector between simulation base station and spectrum analyzer.
- c. The center frequency of spectrum is the band edge frequency and span is 1~5 MHz. RBW of the spectrum is 20kHz and VBW of the spectrum is 100 kHz. (LTE bandwidth 1.4MHz)
- d. Record the max trace plot into the test report.

### 3.5.4 TEST RESULTS

The test results please refer the module Reports No.:SD72132148-1017A REV.1.

### 3.6 CONDUCTED SPURIOUS EMISSIONS

#### 3.6.1 LIMITS OF CONDUCTED SPURIOUS EMISSIONS MEASUREMENT

The power of any emission outside a licensee's frequency block shall be attenuated below the transmitter power (P) by at least  $43 + 10 \log_{10}(P)$  dB. The limit of emission equal to  $-13\text{dBm}$

#### 3.6.2 TEST PROCEDURE

- a. The EUT makes a phone call to the communication simulator. All measurements were done at middle operational frequency range.
- b. Measuring frequency range is from 30 MHz to 19.1GHz for LTE Band 4 and 30 MHz to 9GHz for LTE Band 12& LTE Band 13. 10dB attenuation pad is connected with spectrum. RBW=1MHz and VBW=3MHz are used for conducted emission measurement.

#### 3.6.3 TEST SETUP

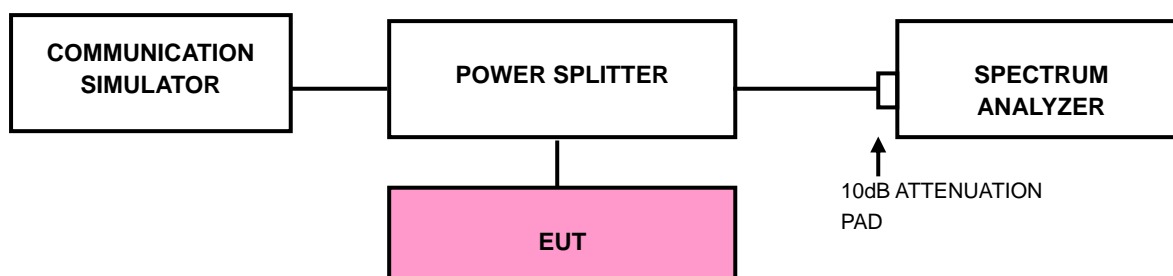

#### 3.6.4 TEST RESULTS

The test results please refer the module Reports No.:SD72132148-1017A REV.1.



### 3.7 RADIATED EMISSION MEASUREMENT

#### 3.7.1 LIMITS OF RADIATED EMISSION MEASUREMENT

The power of any emission outside a licensee's frequency block shall be attenuated below the transmitter power (P) by at least  $43 + 10 \log_{10}(P)$  dB. The limit of emission equal to  $-13\text{dBm}$

#### 3.7.2 TEST PROCEDURES

- a. Substitution method is used for E.I.R.P measurement. In the semi-anechoic chamber, EUT placed on the 0.8m height of Turn Table, rotated the table around 360 degrees to search the maximum radiation power and receiver antenna shall be rotated vertical and horizontal polarization and moved height from 1m to 4m to find the maximum polar radiated power. The "Read Value" is the spectrum reading the maximum power value.
- b. The substitution horn antenna is substituted for EUT at the same position and signals generator export the CW signal to the substitution antenna via a TX cable. Rotated the Turn Table and moved receiving antenna to find the maximum radiation power. Adjust output power level of S.G to get a Value of spectrum reading equal to "Read Value" of step a. Record the power level of S.G
- c.  $\text{EIRP} = \text{Output power level of S.G} - \text{TX cable loss} + \text{Antenna gain of substitution horn}$ .
- d. E.R.P power can be calculated form E.I.R.P power by subtracting the gain of dipole,  $\text{E.R.P power} = \text{E.I.P.R power} - 2.15\text{dBi}$ .

**NOTE:** The resolution bandwidth of spectrum analyzer is 1 MHz and the video bandwidth is 3 MHz.

#### 3.7.3 DEVIATION FROM TEST STANDARD

No deviation



### 3.7.4 TEST SETUP

#### < Frequency Range 30MHz~1GHz >

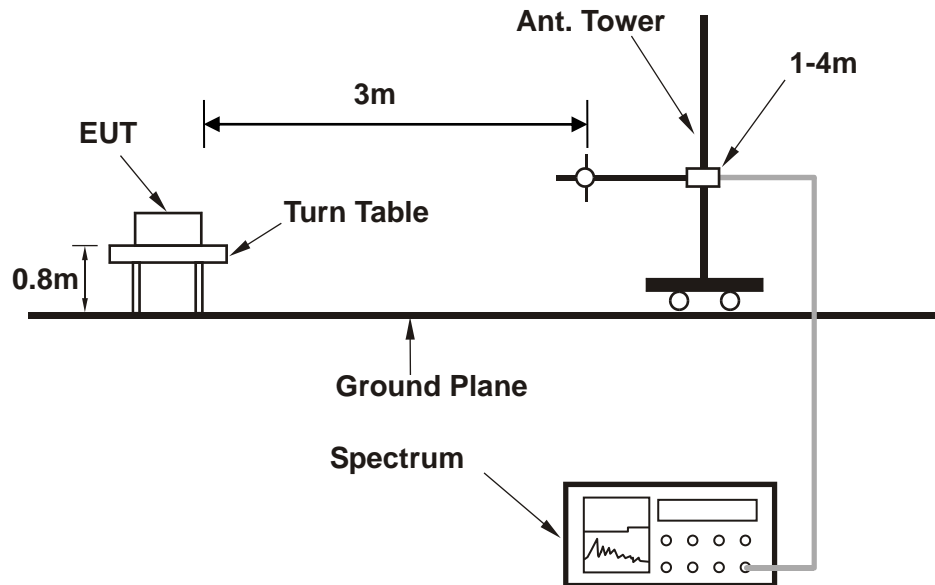

#### < Frequency Range above 1GHz >

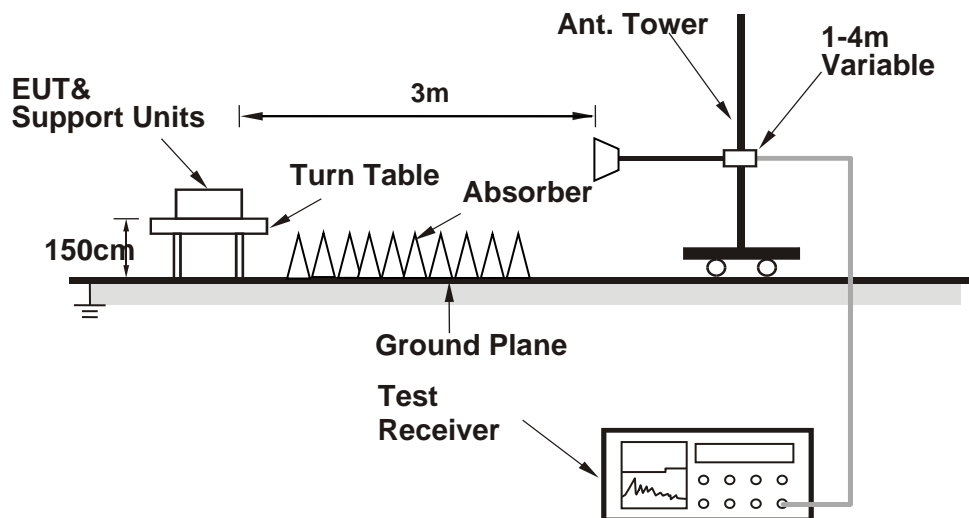

For the actual test configuration, please refer to the attached file (Test Setup Photo).



Test Report No.: RFP20120006-3

### 3.7.5 TEST RESULTS

#### BELOW 1GHz WORST-CASE DATA

30 MHz – 1GHz data:

LTE BAND 13:

CHANNEL BANDWIDTH: 1.4MHz / QPSK

MODE	TX channel 23230	FREQUENCY RANGE	Below 1000MHz
ENVIRONMENTAL CONDITIONS	23deg. C, 70%RH	INPUT POWER	DC 3.8V
TESTED BY	Star Le		
<b>ANTENNA POLARITY &amp; TEST DISTANCE: HORIZONTAL AT 3 M</b>			

	Freq	Level	Read Level	Limit Line	Over Limit	Factor	Remark	Pol/Phase
	MHz	dBm/m	dBm	dBm/m	dB	dB/m		
1	39.700	-45.70	-59.25	-13.00	-32.70	13.55	Peak	Horizontal
2	85.290	-41.38	-49.69	-13.00	-28.38	8.31	Peak	Horizontal
3	117.300	-39.31	-47.97	-13.00	-26.31	8.66	Peak	Horizontal
4	154.160	-39.99	-50.02	-13.00	-26.99	10.03	Peak	Horizontal
5	213.330	-41.54	-52.93	-13.00	-28.54	11.39	Peak	Horizontal
6 PP	399.570	-34.60	-51.79	-13.00	-21.60	17.19	Peak	Horizontal

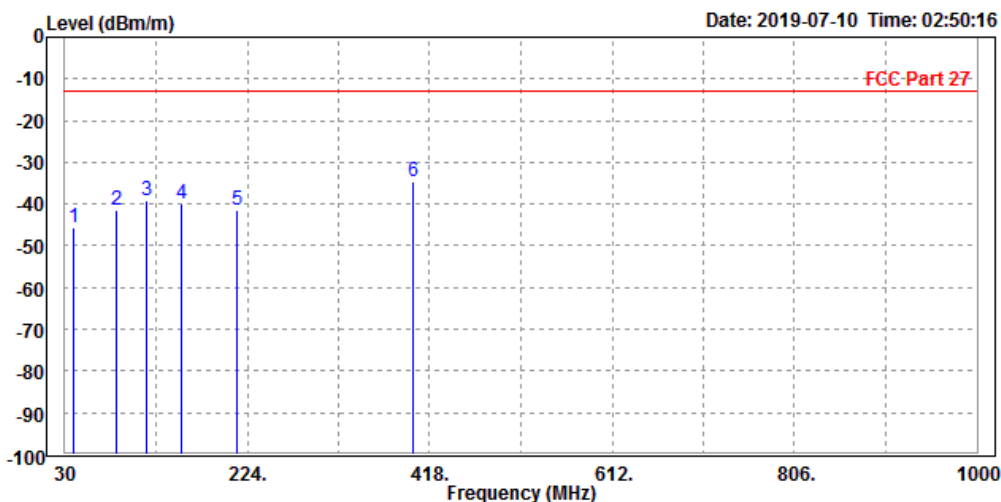



Test Report No.: RFP20120006-3

<b>MODE</b>	TX channel 23230	<b>FREQUENCY RANGE</b>	Below 1000MHz
<b>ENVIRONMENTAL CONDITIONS</b>	23deg. C, 70%RH	<b>INPUT POWER</b>	DC 3.8V
<b>TESTED BY</b>	Star Le		
<b>ANTENNA POLARITY &amp; TEST DISTANCE: VERTICAL AT 3 M</b>			

	Freq	Level	Read Level	Limit Line	Over Limit	Factor	Remark	Pol/Phase
	MHz	dBm/m	dBm	dBm/m	dB	dB/m		
1	39.700	-33.02	-46.74	-13.00	-20.02	13.72	Peak	Vertical
2	92.080	-43.39	-52.24	-13.00	-30.39	8.85	Peak	Vertical
3	132.820	-45.86	-54.59	-13.00	-32.86	8.73	Peak	Vertical
4 PP	392.780	-32.52	-49.60	-13.00	-19.52	17.08	Peak	Vertical
5	431.580	-37.30	-55.04	-13.00	-24.30	17.74	Peak	Vertical
6	584.840	-41.33	-61.22	-13.00	-28.33	19.89	Peak	Vertical

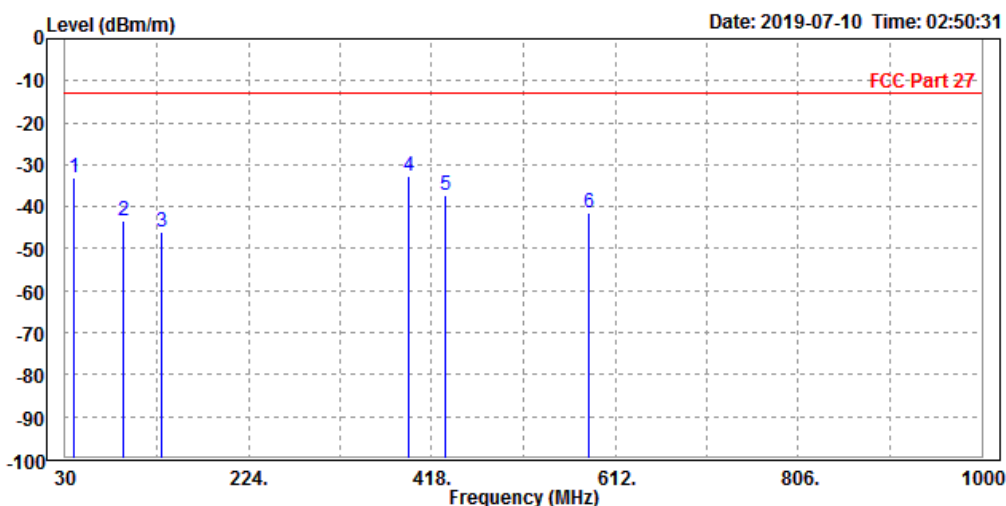



Test Report No.: RFP20120006-3

**ABOVE 1GHz**

**Note:** For higher frequency, the emission is too low to be detected.

**LTE BAND 4**

**CHANNEL BANDWIDTH: 1.4MHz / QPSK**

**CH19957**

<b>MODE</b>	TX channel 19957	<b>FREQUENCY RANGE</b>	Above 1000MHz
<b>ENVIRONMENTAL CONDITIONS</b>	23deg. C, 70%RH	<b>INPUT POWER</b>	DC 3.8V
<b>TESTED BY</b>	Star Le		
<b>ANTENNA POLARITY &amp; TEST DISTANCE: HORIZONTAL AT 3 M</b>			

	Freq	Level	Read Level	Limit Line	Over Limit	Factor	Remark	Pol/Phase
	MHz	dBm/m	dBm	dBm/m	dB	dB/m		
1	PP 3418.000	-50.61	-52.46	-13.00	-37.61	1.85	Peak	Horizontal
2	5132.000	-56.72	-65.25	-13.00	-43.72	8.53	Peak	Horizontal

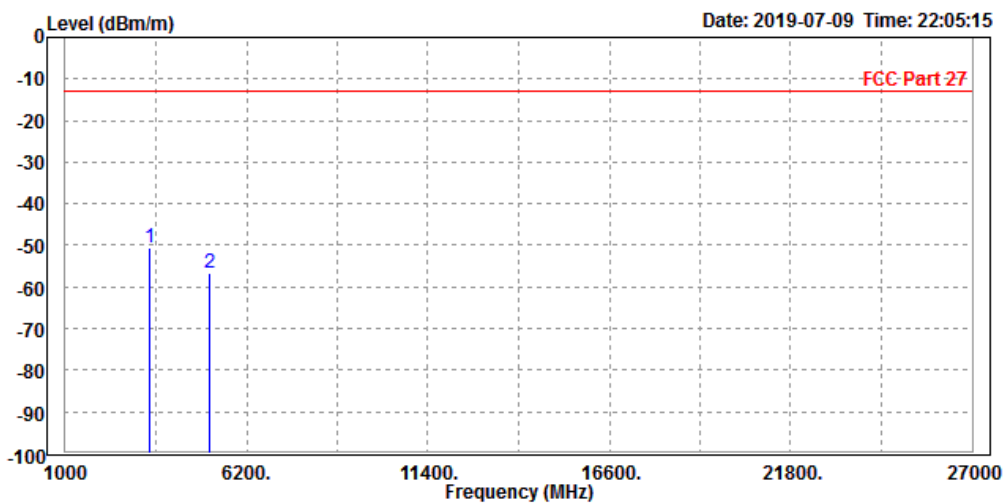



Test Report No.: RFP20120006-3

<b>MODE</b>	TX channel 19957	<b>FREQUENCY RANGE</b>	Above 1000MHz
<b>ENVIRONMENTAL CONDITIONS</b>	23deg. C, 70%RH	<b>INPUT POWER</b>	DC 3.8V
<b>TESTED BY</b>	Star Le		
<b>ANTENNA POLARITY &amp; TEST DISTANCE: VERTICAL AT 3 M</b>			

	Freq	Level	Read Level	Limit Line	Over Limit	Factor	Remark	PoI/Phase
	MHz	dBm/m	dBm	dBm/m	dB	dB/m		
1	PP 3418.000	-50.20	-52.67	-13.00	-37.20	2.47	Peak	Vertical
2	5132.000	-56.24	-64.23	-13.00	-43.24	7.99	Peak	Vertical

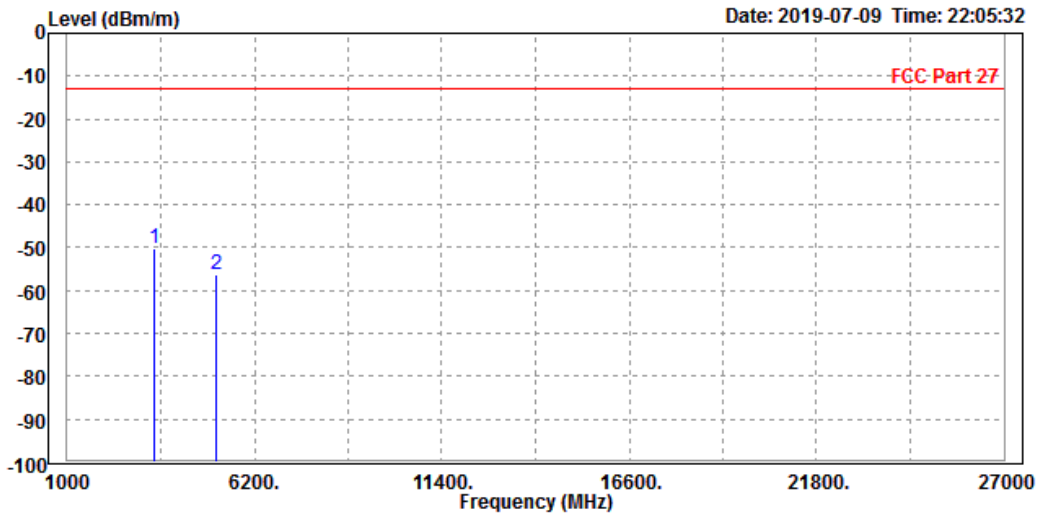



Test Report No.: RFP20120006-3

CH20175

<b>MODE</b>	TX channel 20175	<b>FREQUENCY RANGE</b>	Above 1000MHz
<b>ENVIRONMENTAL CONDITIONS</b>	23deg. C, 70%RH	<b>INPUT POWER</b>	DC 3.8V
<b>TESTED BY</b>	Star Le		
<b>ANTENNA POLARITY &amp; TEST DISTANCE: HORIZONTAL AT 3 M</b>			

	Freq	Level	Read Level	Limit Line	Over Limit	Factor	Remark	Pol/Phase
	MHz	dBm/m	dBm	dBm/m	dB	dB/m		
1 PP	3470.000	-50.31	-52.36	-13.00	-37.31	2.05	Peak	Horizontal
2	5197.000	-55.54	-64.15	-13.00	-42.54	8.61	Peak	Horizontal

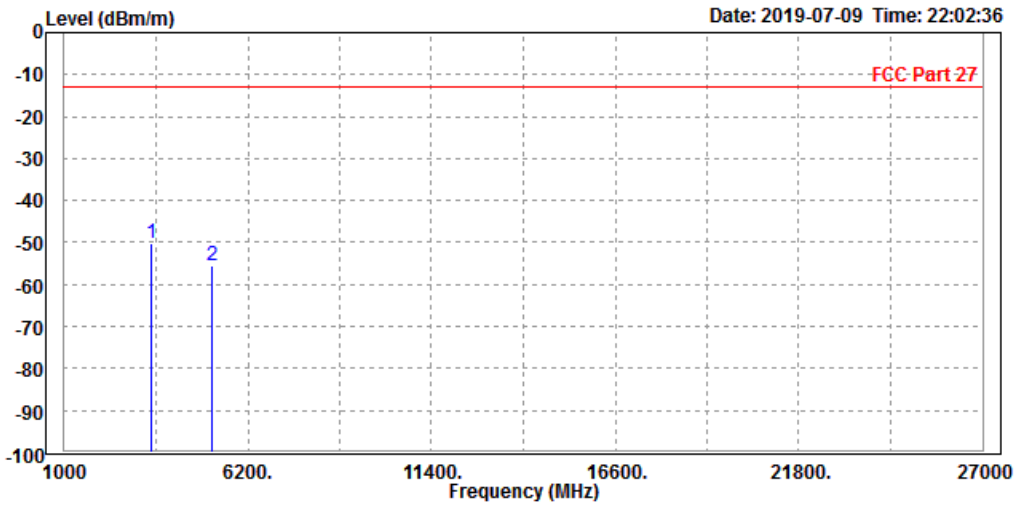



Test Report No.: RFP20120006-3

<b>MODE</b>	TX channel 20175	<b>FREQUENCY RANGE</b>	Above 1000MHz
<b>ENVIRONMENTAL CONDITIONS</b>	23deg. C, 70%RH	<b>INPUT POWER</b>	DC 3.8V
<b>TESTED BY</b>	Star Le		
<b>ANTENNA POLARITY &amp; TEST DISTANCE: VERTICAL AT 3 M</b>			

	Freq	Level	Read Level	Limit Line	Over Limit	Factor	Remark	Pol/Phase
	MHz	dBm/m	dBm	dBm/m	dB	dB/m		
1	PP 3470.000	-51.68	-54.21	-13.00	-38.68	2.53	Peak	Vertical
2	5197.000	-57.50	-65.48	-13.00	-44.50	7.98	Peak	Vertical

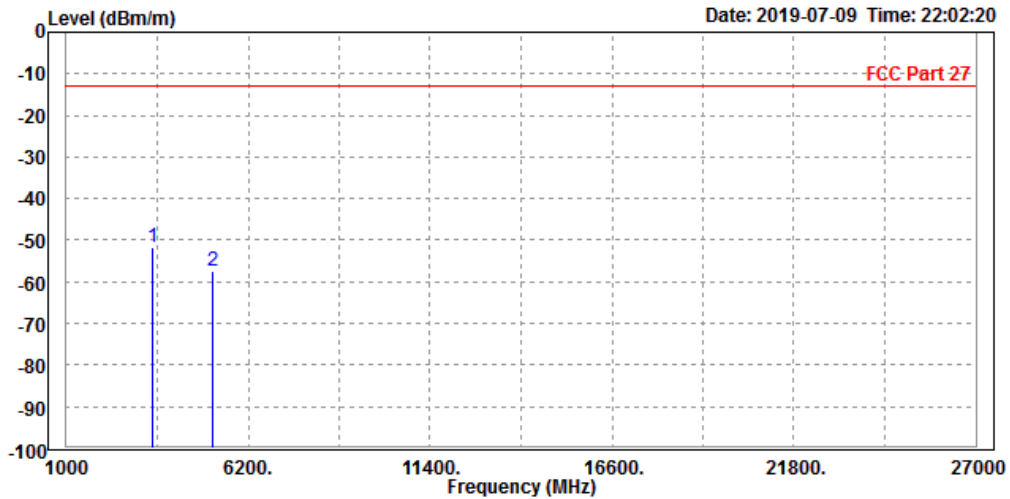



Test Report No.: RFP20120006-3

CH20393

MODE	TX channel 20393	FREQUENCY RANGE	Above 1000MHz
ENVIRONMENTAL CONDITIONS	23deg. C, 70%RH	INPUT POWER	DC 3.8V
TESTED BY	Star Le		
<b>ANTENNA POLARITY &amp; TEST DISTANCE: HORIZONTAL AT 3 M</b>			

	Freq	Level	Read Level	Limit Line	Over Limit	Factor	Remark	Pol/Phase
	MHz	dBm/m	dBm	dBm/m	dB	dB/m		
1	PP 3502.000	-50.48	-52.65	-13.00	-37.48	2.17	Peak	Horizontal
2	5266.000	-55.69	-64.38	-13.00	-42.69	8.69	Peak	Horizontal

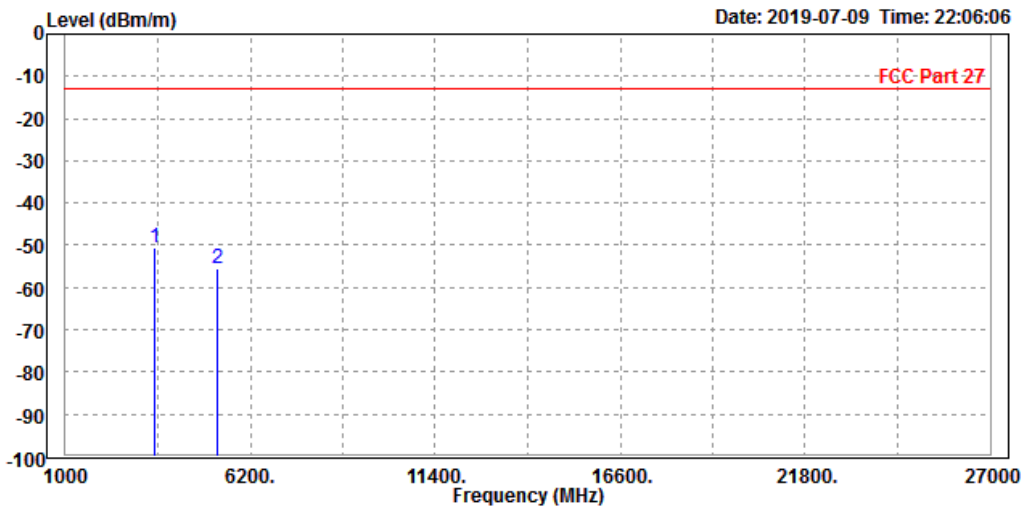





Test Report No.: RFP20120006-3

MODE	TX channel 20393	FREQUENCY RANGE	Above 1000MHz
ENVIRONMENTAL CONDITIONS	23deg. C, 70%RH	INPUT POWER	DC 3.8V
TESTED BY	Star Le		
ANTENNA POLARITY & TEST DISTANCE: VERTICAL AT 3 M			

	Freq	Level	Read Level	Limit Line	Over Limit	Factor	Remark	Pol/Phase
	MHz	dBm/m	dBm	dBm/m	dB	dB/m		
1	PP 3502.000	-50.11	-52.69	-13.00	-37.11	2.58	Peak	Vertical
2	5266.000	-57.23	-65.21	-13.00	-44.23	7.98	Peak	Vertical

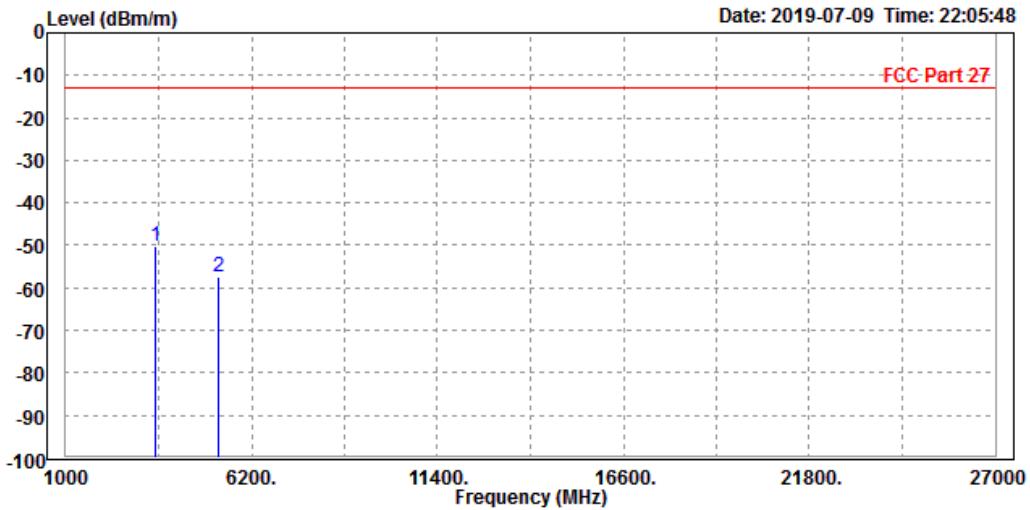



Test Report No.: RFP20120006-3

LTE BAND 12

CHANNEL BANDWIDTH: 1.4MHz / QPSK

CH23017

MODE	TX channel 23017	FREQUENCY RANGE	Above 1000MHz
ENVIRONMENTAL CONDITIONS	23deg. C, 70%RH	INPUT POWER	DC 3.8V
TESTED BY	Star Le		
<b>ANTENNA POLARITY &amp; TEST DISTANCE: HORIZONTAL AT 3 M</b>			

	Freq	Level	Read Level	Limit Line	Over Limit	Factor	Remark	Pol/Phase
	MHz	dBm/m	dBm	dBm/m	dB	dB/m		
1	PP 1390.000	-52.77	-45.89	-13.00	-39.77	-6.88	Peak	Horizontal
2	2101.500	-66.10	-64.15	-13.00	-53.10	-1.95	Peak	Horizontal

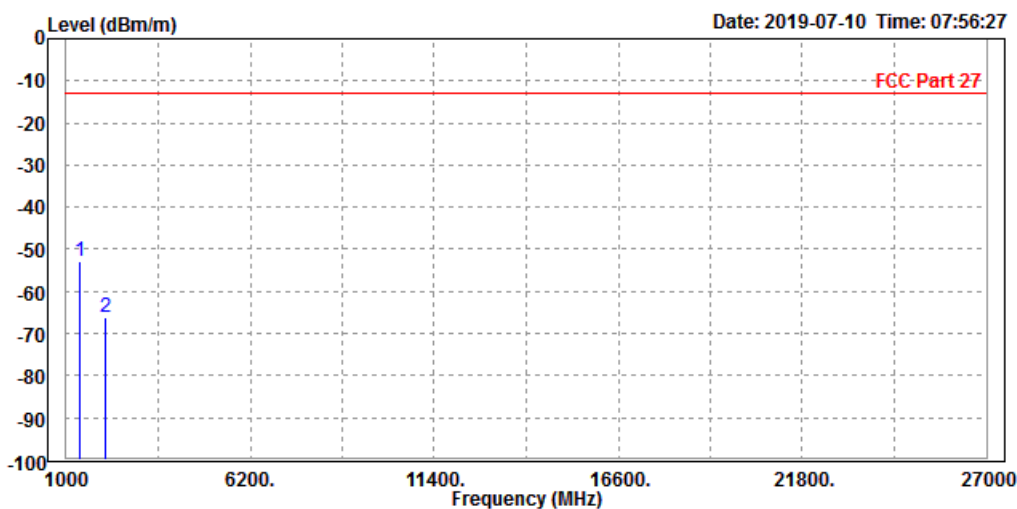



Test Report No.: RFP20120006-3

MODE	TX channel 23017	FREQUENCY RANGE	Above 1000MHz
ENVIRONMENTAL CONDITIONS	23deg. C, 70%RH	INPUT POWER	DC 3.8V
TESTED BY	Star Le		
<b>ANTENNA POLARITY &amp; TEST DISTANCE: VERTICAL AT 3 M</b>			

	Freq	Level	Read Level	Limit Line	Over Limit	Factor	Remark	Pol/Phase
	MHz	dBm/m	dBm	dBm/m	dB	dB/m		
1	PP 1390.000	-50.72	-45.12	-13.00	-37.72	-5.60	Peak	Vertical
2	2101.500	-63.50	-63.25	-13.00	-50.50	-0.25	Peak	Vertical

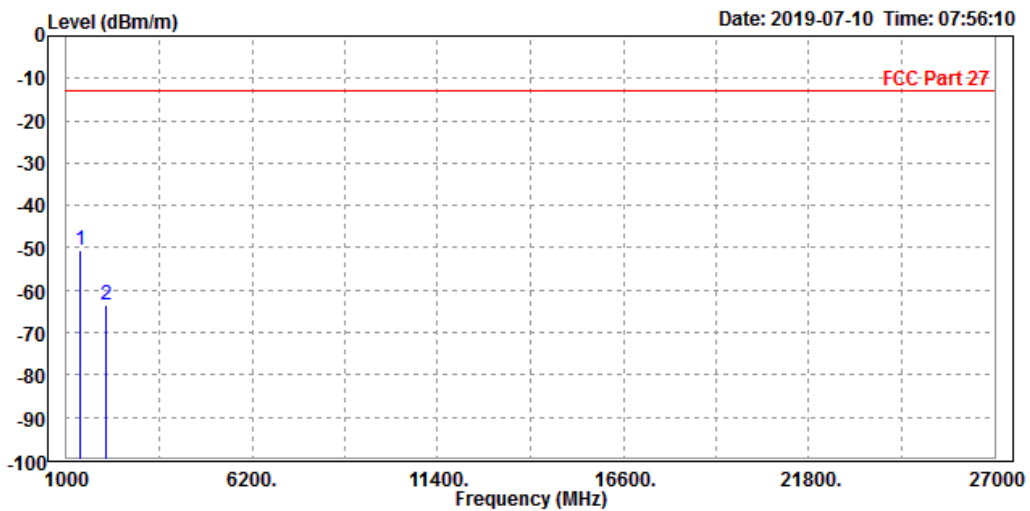



Test Report No.: RFP20120006-3

CH23095

MODE	TX channel 23095	FREQUENCY RANGE	Above 1000MHz
ENVIRONMENTAL CONDITIONS	23deg. C, 70%RH	INPUT POWER	DC 3.8V
TESTED BY	Star Le		
<b>ANTENNA POLARITY &amp; TEST DISTANCE: HORIZONTAL AT 3 M</b>			

	Freq	Level	Read Level	Limit Line	Over Limit	Factor	Remark	Pol/Phase
	MHz	dBm/m	dBm	dBm/m	dB	dB/m		
1	PP 1416.000	-53.30	-46.58	-13.00	-40.30	-6.72	Peak	Horizontal
2	2122.500	-65.25	-63.32	-13.00	-52.25	-1.93	Peak	Horizontal

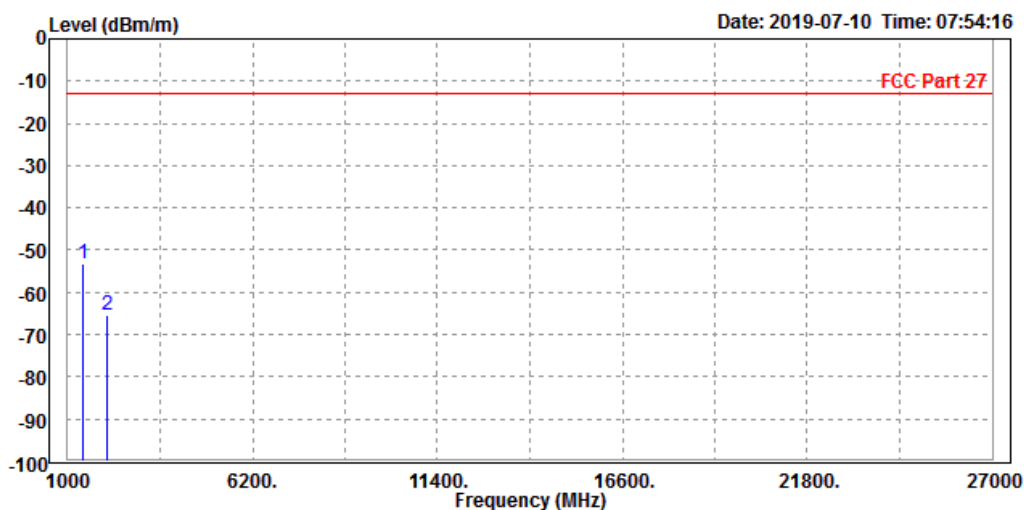



Test Report No.: RFP20120006-3

<b>MODE</b>	TX channel 23095	<b>FREQUENCY RANGE</b>	Above 1000MHz
<b>ENVIRONMENTAL CONDITIONS</b>	23deg. C, 70%RH	<b>INPUT POWER</b>	DC 3.8V
<b>TESTED BY</b>	Star Le		
<b>ANTENNA POLARITY &amp; TEST DISTANCE: VERTICAL AT 3 M</b>			

	Freq	Level	Read Level	Limit Line	Over Limit	Factor	Remark	Pol/Phase
	MHz	dBm/m	dBm	dBm/m	dB	dB/m		
1	PP 1416.000	-51.65	-46.21	-13.00	-38.65	-5.44	Peak	Vertical
2	2122.500	-62.82	-62.58	-13.00	-49.82	-0.24	Peak	Vertical

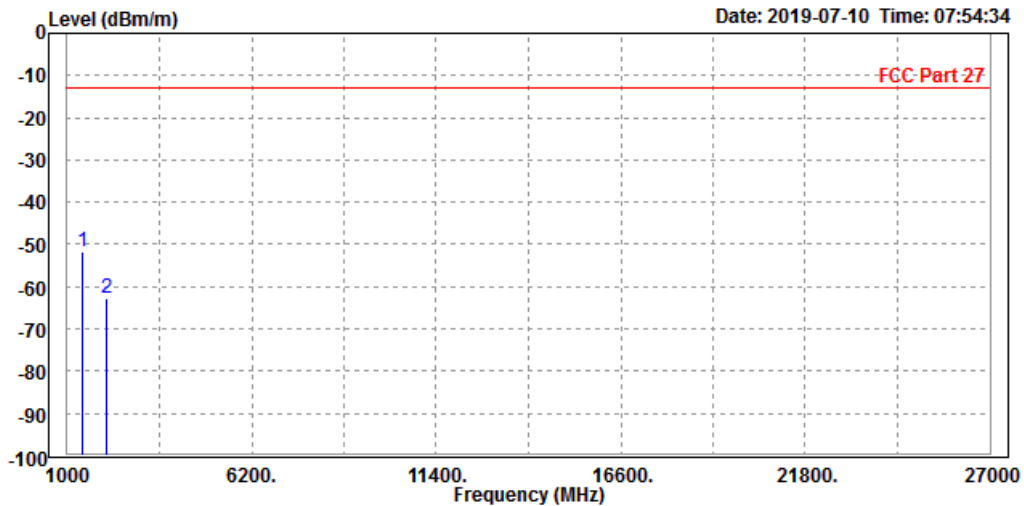



Test Report No.: RFP20120006-3

CH23173

<b>MODE</b>	TX channel 23173	<b>FREQUENCY RANGE</b>	Above 1000MHz
<b>ENVIRONMENTAL CONDITIONS</b>	23deg. C, 70%RH	<b>INPUT POWER</b>	DC 3.8V
<b>TESTED BY</b>	Star Le		
<b>ANTENNA POLARITY &amp; TEST DISTANCE: HORIZONTAL AT 3 M</b>			

	Freq	Level	Read Level	Limit Line	Over Limit	Factor	Remark	Pol/Phase
	MHz	dBm/m	dBm	dBm/m	dB	dB/m		
1	PP 1416.000	-51.57	-44.85	-13.00	-38.57	-6.72	Peak	Horizontal
2	2143.500	-64.34	-62.42	-13.00	-51.34	-1.92	Peak	Horizontal

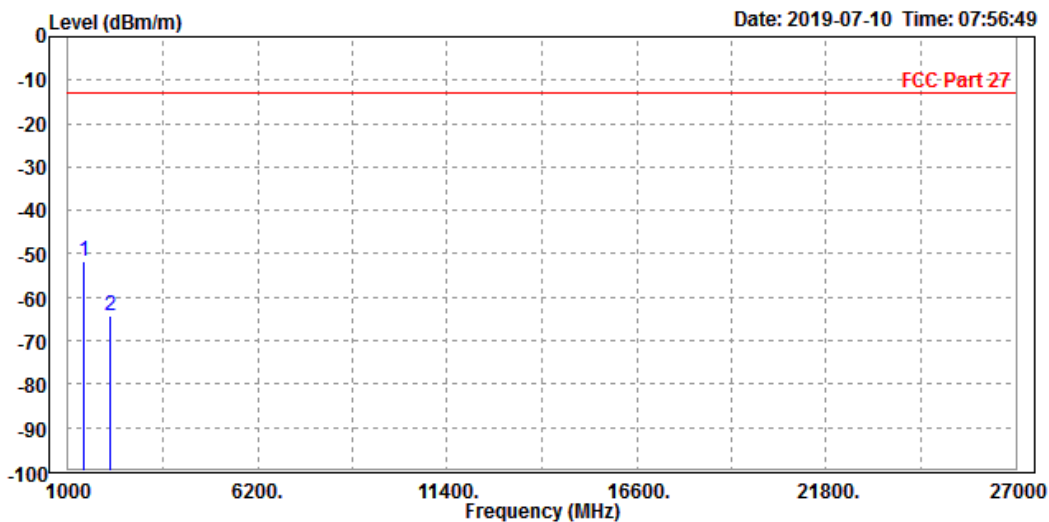



Test Report No.: RFP20120006-3

<b>MODE</b>	TX channel 23173	<b>FREQUENCY RANGE</b>	Above 1000MHz
<b>ENVIRONMENTAL CONDITIONS</b>	23deg. C, 70%RH	<b>INPUT POWER</b>	DC 3.8V
<b>TESTED BY</b>	Star Le		
<b>ANTENNA POLARITY &amp; TEST DISTANCE: VERTICAL AT 3 M</b>			

	Freq	Level	Read Level	Limit Line	Over Limit	Factor	Remark	Pol/Phase
	MHz	dBm/m	dBm	dBm/m	dB	dB/m		
1	PP 1416.000	-51.95	-46.51	-13.00	-38.95	-5.44	Peak	Vertical
2	2143.500	-63.59	-63.35	-13.00	-50.59	-0.24	Peak	Vertical

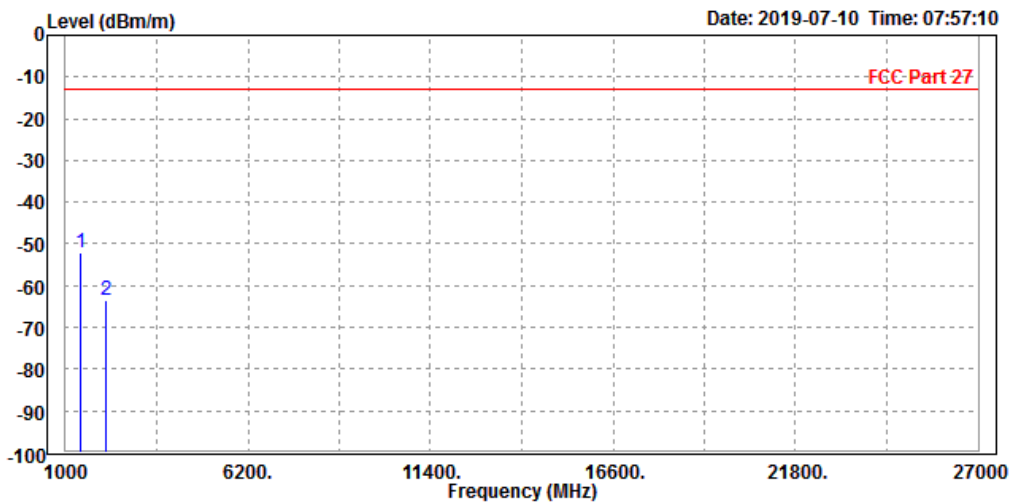



Test Report No.: RFP20120006-3

LTE BAND 13

CHANNEL BANDWIDTH: 1.4MHz / QPSK

CH 23187

MODE	TX channel 23187	FREQUENCY RANGE	Above 1000MHz
ENVIRONMENTAL CONDITIONS	23deg. C, 70%RH	INPUT POWER	DC 3.8V
TESTED BY	Star Le		
<b>ANTENNA POLARITY &amp; TEST DISTANCE: HORIZONTAL AT 3 M</b>			

	Freq	Level	Read Level	Limit Line	Over Limit	Factor	Remark	Pol/Phase
	MHz	dBm/m	dBm	dBm/m	dB	dB/m		
1	PP 1572.000	-57.95	-52.35	-40.00	-17.95	-5.60	Peak	Horizontal
2	2338.500	-58.04	-56.28	-13.00	-45.04	-1.76	Peak	Horizontal

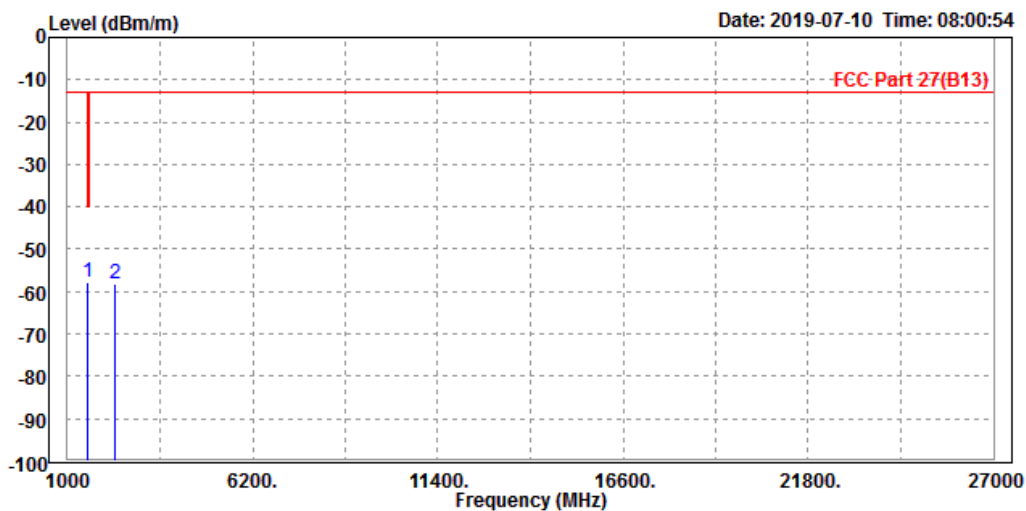





Test Report No.: RFP20120006-3

<b>MODE</b>	TX channel 23187	<b>FREQUENCY RANGE</b>	Above 1000MHz
<b>ENVIRONMENTAL CONDITIONS</b>	23deg. C, 70%RH	<b>INPUT POWER</b>	DC 3.8V
<b>TESTED BY</b>	Star Le		
<b>ANTENNA POLARITY &amp; TEST DISTANCE: VERTICAL AT 3 M</b>			

	Freq	Level	Read Level	Limit Line	Over Limit	Factor	Remark	Pol/Phase
	MHz	dBm/m	dBm	dBm/m	dB	dB/m		
1 PP	1572.000	-55.28	-51.02	-40.00	-15.28	-4.26	Peak	Vertical
2	2338.500	-55.61	-55.41	-13.00	-42.61	-0.20	Peak	Vertical

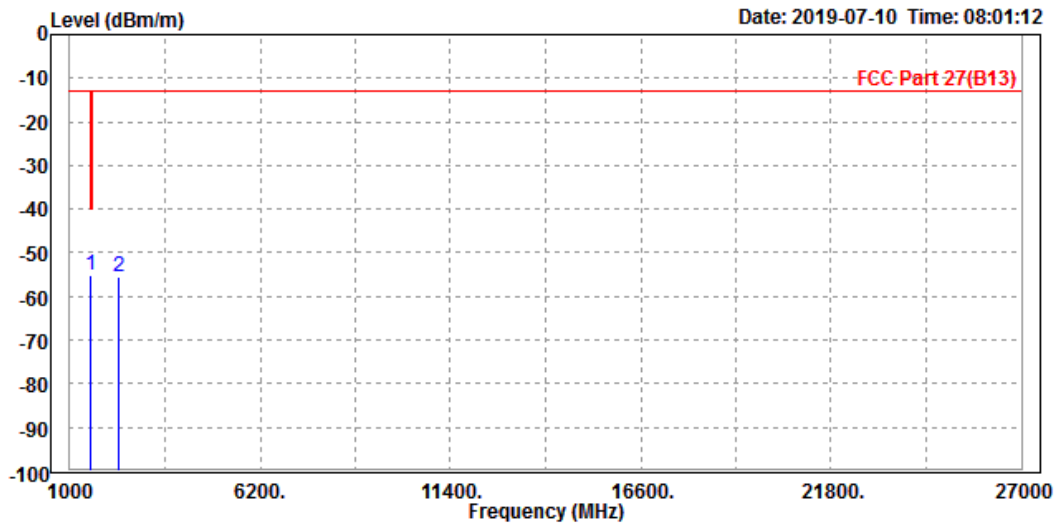



Test Report No.: RFP20120006-3

CH 23230

MODE	TX channel 23230	FREQUENCY RANGE	Above 1000MHz
ENVIRONMENTAL CONDITIONS	23deg. C, 70%RH	INPUT POWER	DC 3.8V
TESTED BY	Star Le		
ANTENNA POLARITY & TEST DISTANCE: HORIZONTAL AT 3 M			

	Freq	Level	Read Level	Limit Line	Over Limit	Factor	Remark	Pol/Phase
	MHz	dBm/m	dBm	dBm/m	dB	dB/m		
1 PP	1572.000	-55.96	-50.36	-40.00	-15.96	-5.60	Peak	Horizontal
2	2346.000	-56.97	-55.21	-13.00	-43.97	-1.76	Peak	Horizontal

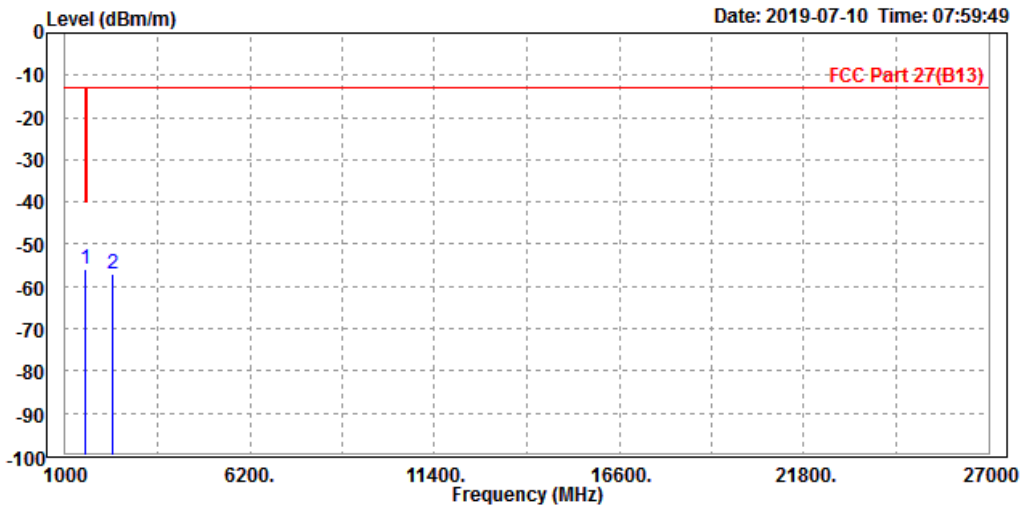



Test Report No.: RFP20120006-3

MODE	TX channel 23230	FREQUENCY RANGE	Above 1000MHz
ENVIRONMENTAL CONDITIONS	23deg. C, 70%RH	INPUT POWER	DC 3.8V
TESTED BY	Star Le		
<b>ANTENNA POLARITY &amp; TEST DISTANCE: VERTICAL AT 3 M</b>			

	Freq	Level	Read Level	Limit Line	Over Limit	Factor	Remark	Pol/Phase
	MHz	dBm/m	dBm	dBm/m	dB	dB/m		
1	PP 1572.000	-54.49	-50.23	-40.00	-14.49	-4.26	Peak	Vertical
2	2346.000	-54.88	-54.68	-13.00	-41.88	-0.20	Peak	Vertical

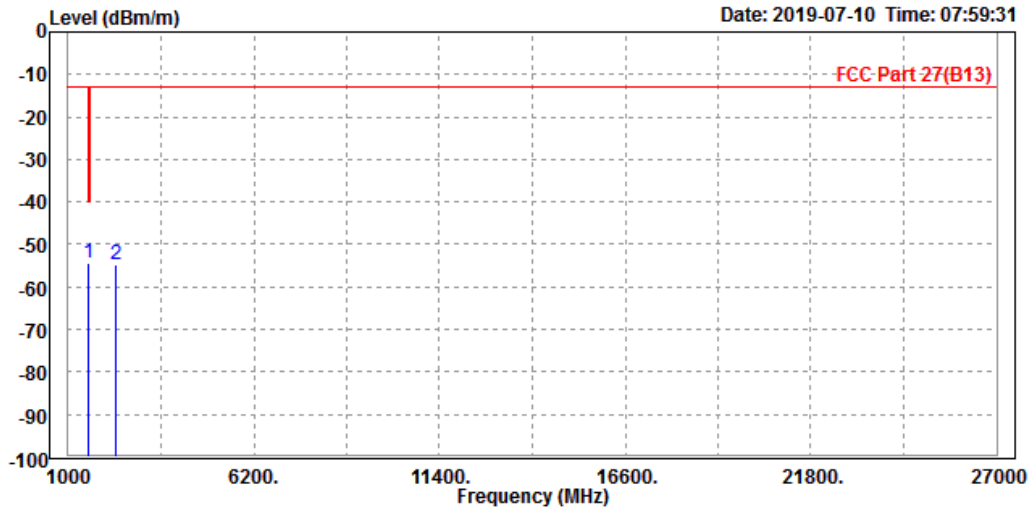



Test Report No.: RFP20120006-3

CH 23273

MODE	TX channel 23273	FREQUENCY RANGE	Above 1000MHz
ENVIRONMENTAL CONDITIONS	23deg. C, 70%RH	INPUT POWER	DC 3.8V
TESTED BY	Star Le		
<b>ANTENNA POLARITY &amp; TEST DISTANCE: HORIZONTAL AT 3 M</b>			

	Freq	Level	Read Level	Limit Line	Over Limit	Factor	Remark	Pol/Phase
	MHz	dBm/m	dBm	dBm/m	dB	dB/m		
1	PP 1572.000	-56.68	-51.08	-40.00	-16.68	-5.60	Peak	Horizontal
2	2353.500	-56.42	-54.67	-13.00	-43.42	-1.75	Peak	Horizontal

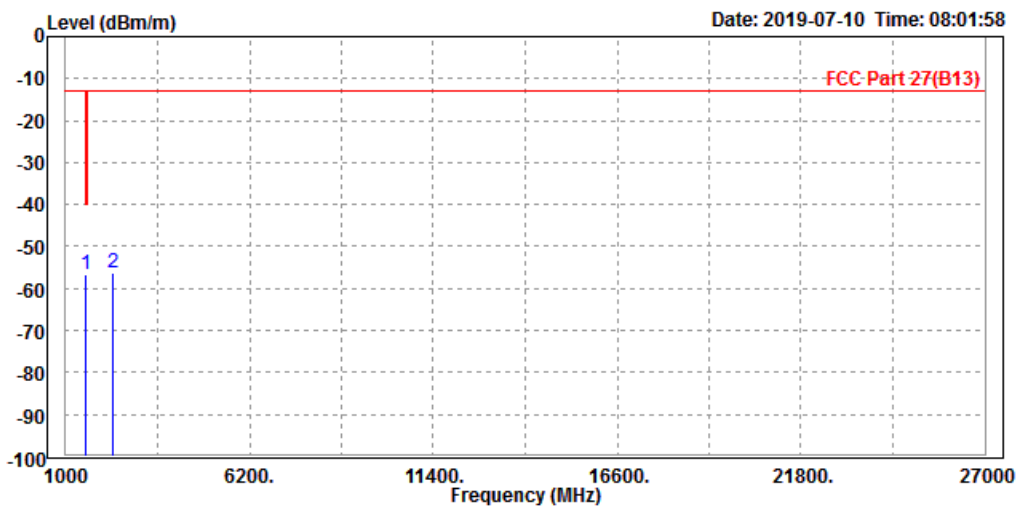



Test Report No.: RFP20120006-3

MODE	TX channel 23273	FREQUENCY RANGE	Above 1000MHz
ENVIRONMENTAL CONDITIONS	23deg. C, 70%RH	INPUT POWER	DC 3.8V
TESTED BY	Star Le		
ANTENNA POLARITY & TEST DISTANCE: VERTICAL AT 3 M			

	Read	Limit	Over			
Freq	Level	Level	Line	Limit	Factor	Remark
MHz	dBm/m	dBm	dBm/m	dB	dB/m	Pol/Phase
1 PP 1572.000	-54.60	-50.34	-40.00	-14.60	-4.26	Peak Vertical
2 2353.500	-55.26	-55.06	-13.00	-42.26	-0.20	Peak Vertical

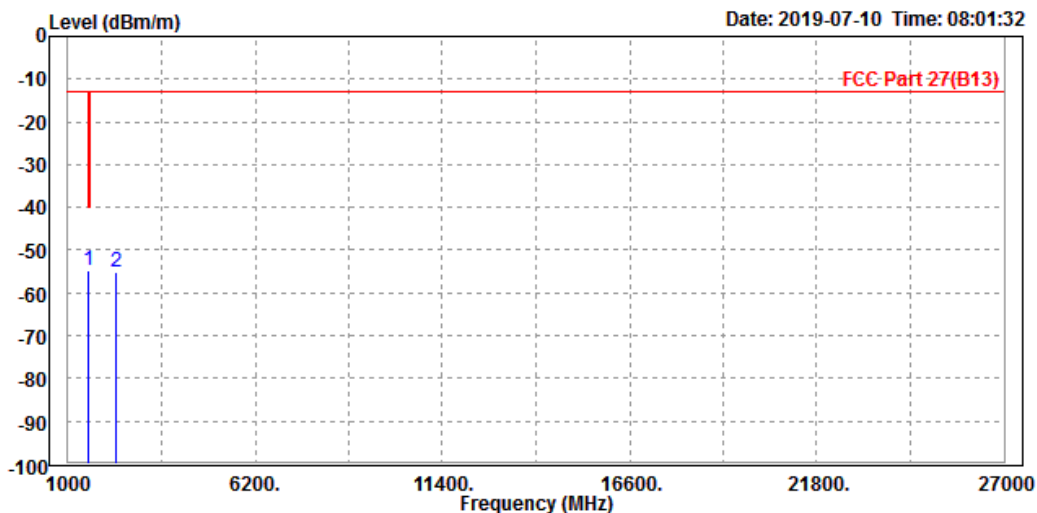



Test Report No.: RFP20120006-3

## 4 INFORMATION ON THE TESTING LABORATORIES

We, BV 7LAYERS COMMUNICATIONS TECHNOLOGY (SHENZHEN) CO. LTD., were founded in 2015 to provide our best service in EMC, Radio, Telecom and Safety consultation. Our laboratories are accredited and approved according to ISO/IEC 17025.

If you have any comments, please feel free to contact us at the following:

**Shenzhen EMC/RF Lab:**

Tel: +86-755-88696566

Fax: +86-755-88696577

**Email:** [customerservice.dg@cn.bureauveritas.com](mailto:customerservice.dg@cn.bureauveritas.com)

**Web Site:** [www.adt.com.tw](http://www.adt.com.tw)

The address and road map of all our labs can be found in our web site also.



Test Report No.: RFP20120006-3

## 5 APPENDIX A – MODIFICATIONS RECORDERS FOR ENGINEERING CHANGES TO THE EUT BY THE LAB

No modifications were made to the EUT by the lab during the test.

---END---