

IC TEST REPORT

(RSS-130)

Applicant:	Particle Industries, Inc
Address:	126 Post St,4th floor, San Francisco, CA 94108 USA

Manufacturer or Supplier:	Particle Industries, Inc
Address:	126 Post St,4th floor, San Francisco, CA 94108 USA
Product:	Electron
Brand Name:	Particle
Model Name:	ELC402, ELC404
IC:	8585A-2AGQN4NNN
Date of tests:	Oct. 17, 2019 ~ Nov. 28, 2019

The tests have been carried out according to the requirements of the following standard:

- RSS-130 Issue 2, February, 2019**
- RSS-Gen Issue 5, Amendment 1, March 2019**
- ANSI C63.26-2015**

CONCLUSION: The submitted sample was found to COMPLY with the test requirement

Remark: This test report is for internal customer use only, not as a final certification test report.

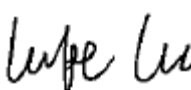
Prepared by Alex Chen Engineer / Mobile Department	Approved by Luke Lu Manager / Mobile Department
 Date: Dec. 23, 2020	 Date: Dec. 23, 2020

This report is governed by, and incorporates by reference, CPS Conditions of Service as posted at the date of issuance of this report at <http://www.bureauveritas.com/home/about-us/our-business/cps/about-us/terms-conditions> and is intended for your exclusive use. Any copying or replication of this report to or for any other person or entity, or use of our name or trademark, is permitted only with our prior written permission. This report sets forth our findings solely with respect to the test samples identified herein. The results set forth in this report are not indicative or representative of the quality or characteristics of the lot from which a test sample was taken or any similar or identical product unless specifically and expressly noted. Our report includes all of the tests requested by you and the results thereof based upon the information that you provided to us. Measurement uncertainty is only provided upon request for accredited tests. You have 60 days from date of issuance of this report to notify us of any material error or omission caused by our negligence or if you require measurement uncertainty; provided, however, that such notice shall be in writing and shall specifically address the issue you wish to raise. A failure to raise such issue within the prescribed time shall constitute your unqualified acceptance of the completeness of this report, the tests conducted and the correctness of the report contents.



TABLE OF CONTENTS

RELEASE CONTROL RECORD 4

1 SUMMARY OF TEST RESULTS 5

1.1 MEASUREMENT UNCERTAINTY 6

1.2 TEST SITE AND INSTRUMENTS 7

2 GENERAL INFORMATION..... 8

2.1 GENERAL DESCRIPTION OF EUT 8

2.2 CONFIGURATION OF SYSTEM UNDER TEST 10

2.3 DESCRIPTION OF SUPPORT UNITS11

2.4 DESCRIPTION OF TEST MODES.....11

2.5 GENERAL DESCRIPTION OF APPLIED STANDARDS 14

2.6 TRANSMIT ANTENNA 14

3 TEST TYPES AND RESULTS 15

3.1 OUTPUT POWER MEASUREMENT 15

3.1.1 LIMITS OF OUTPUT POWER MEASUREMENT 15

3.1.2 TEST PROCEDURES 15

3.1.3 TEST SETUP 16

3.1.4 TEST RESULTS 17

3.2 FREQUENCY STABILITY MEASUREMENT 21

3.2.1 LIMITS OF FREQUENCY STABILITY MEASUREMENT 21

3.2.2 TEST PROCEDURE 21

3.2.3 TEST SETUP 21

3.2.4 TEST RESULTS 22

3.3 OCCUPIED BANDWIDTH MEASUREMENT 28

3.3.1 LIMITS OF OCCUPIED BANDWIDTH MEASUREMENT 28

3.3.2 TEST SETUP 28

3.3.3 TEST PROCEDURES 28

3.3.4 TEST RESULTS 29

3.4 PEAK TO AVERAGE RATIO 35

3.4.1 LIMITS OF PEAK TO AVERAGE RATIO MEASUREMENT 35

3.4.2 TEST SETUP 35

3.4.3 TEST PROCEDURES 35

3.4.4 TEST RESULTS 36

3.5 BAND EDGE MEASUREMENT 42

3.5.1 LIMITS OF BAND EDGE MEASUREMENT 42

3.5.2 TEST SETUP 42

3.5.3 TEST PROCEDURES 43

3.5.4 TEST RESULTS 44

3.6 CONDUCTED SPURIOUS EMISSIONS..... 50

3.6.1 LIMITS OF CONDUCTED SPURIOUS EMISSIONS MEASUREMENT 50

3.6.2 TEST PROCEDURE 50

3.6.3 TEST SETUP 51

3.6.4 TEST RESULTS 51

3.7 RADIATED EMISSION MEASUREMENT 57

3.7.1 LIMITS OF RADIATED EMISSION MEASUREMENT 57

3.7.2 TEST PROCEDURES 57

3.7.3 DEVIATION FROM TEST STANDARD 57

3.7.4 TEST SETUP 58

3.7.5 TEST RESULTS 59



4	INFORMATION ON THE TESTING LABORATORIES	81
5	APPENDIX A – MODIFICATIONS RECORDERS FOR ENGINEERING CHANGES TO THE EUT BY THE LAB	82



RELEASE CONTROL RECORD

ISSUE NO.	REASON FOR CHANGE	DATE ISSUED
IC191017W004-4	Original release, This test report is for internal customer use only, not as a final certification test report.	Dec. 05, 2019
ICP20120029-4	Based on the original product add one model name, changed product name. In this report, All test data is copied from the original test report IC191017W004-4.	Dec. 23, 2020



1 SUMMARY OF TEST RESULTS

The EUT has been tested according to the following specifications:

APPLIED STANDARD: IC RSS-130, RSS-Gen		
STANDARD SECTION	TEST TYPE AND LIMIT	RESULT
RSS-Gen		
6.7	Occupied Bandwidth	Compliance
6.8	Transmit antenna	Compliance
STANDARD SECTION	TEST TYPE AND LIMIT	RESULT
RSS-130		
4.5	Frequency Stability AFC Freq. Error vs. Voltage AFC Freq. Error vs. Temperature	Compliance
4.6	Maximum Peak Output Power	Compliance
4.6	peak-to-average power ratio	Compliance
4.7	Band Edge Measurements	Compliance
4.7	Conducted Spurious Emissions	Compliance
4.7	Radiated Spurious Emissions	Compliance



1.1 MEASUREMENT UNCERTAINTY

Where relevant, the following measurement uncertainty levels have been estimated for tests performed on the EUT as specified in ETSI TR 100 028-1 V1.4.1(2001-12):

MEASUREMENT	UNCERTAINTY
Frequency Stability	$\pm 76.97\text{Hz}$
Radiated emissions & Radiated Power (30MHz~1GMHz)	$\pm 4.98\text{dB}$
Radiated emissions & Radiated Power (1GMHz ~6GMHz)	$\pm 4.70\text{dB}$
Radiated emissions (6GMHz ~18GMHz)	$\pm 4.60\text{dB}$
Radiated emissions (18GMHz ~40GMHz)	$\pm 4.12\text{dB}$
Conducted emissions	$\pm 4.01\text{dB}$
Occupied Channel Bandwidth	$\pm 43.58\text{KHz}$
Conducted Output power	$\pm 2.06\text{dB}$
Band Edge Measurements	$\pm 4.70\text{dB}$
Peak to average ratio	$\pm 0.76\text{dB}$

This uncertainty represents an expanded uncertainty expressed at approximately the 95% confidence level using a coverage factor of $k=2$.



1.2 TEST SITE AND INSTRUMENTS

Equipment	Manufacturer	Model No.	Serial No.	Last Cal.	Next Cal.
MXE EMI Receiver	KEYSIGHT	N9038A-544	MY54450026	Feb. 26,19	Feb. 25,20
EXA Signal Analyzer	KEYSIGHT	N9010A-526	MY54510322	Feb. 26,19	Feb. 25,20
Bilog Antenna	ETS-LINDGREN	3143B	00161965	Feb. 26,19	Feb. 25,20
Horn Antenna (1GHz-18GHz)	ETS-LINDGREN	3117	00168692	Nov. 24, 19	Nov. 23, 20
Horn Antenna (18GHz-40GHz)	N/A	QWH-SL-18-40 -K-SG/QMS-00 361	15433	Nov. 24, 19	Nov. 23, 20
Radio Communication Analyzer	ANRITSU	MT8820C	6201465426	Feb. 26,19	Feb. 25,20
Signal Pre-Amplifier	EMSI	EMC 9135	980249	Jun. 24,19	Jun. 23,20
Signal Pre-Amplifier	EMSI	EMC 012645B	980257	Jun. 24,19	Jun. 23,20
Signal Pre-Amplifier	EMSI	EMC 184045B	980259	Jun. 24,19	Jun. 23,20
3m Semi-anechoic Chamber	ETS-LINDGREN	9m*6m*6m	Euroshieldpn- CT0001143-1216	Feb. 26,19	Feb. 25,20
Test Software	E3	V 9.160323	N/A	N/A	N/A
Test Software	ADT	ADT_Radiated _V7.6.15.9.2	N/A	N/A	N/A
10dB Attenuator	JFW/USA	50HF-010-SM A	1505	Jun. 24,19	Jun. 23,20
Power Meter	Anritsu	ML2495A	1506002	Feb. 26,19	Feb. 25,20
Power Sensor	Anritsu	MA2411B	1339352	Feb. 26,19	Feb. 25,20
Humid & Temp Programmable Tester	Juyi	ITH-120-45-CP -AR	IAA1504-001	Jun. 24,19	Jun. 23,20
MXG Analog Microvave Signal Generator	KEYSIGHT	N5183A	MY50143024	Feb. 26,19	Feb. 25,20
Power Divider	MCLI/USA	PS2-15	24880	Jul. 09,19	Jul. 08,20

- NOTE:**
1. The calibration interval of the above test instruments is 12 months or 24 months and the calibrations are traceable to CEPREI/CHINA, GRGT/CHINA and NIM/CHINA.
 2. The test was performed in 3m Semi-anechoic Chamber and RF Oven Room.
 3. The horn antenna is used only for the measurement of emission frequency above 1GHz if tested.
 4. The IC test Site Registration No. is 21771-1; The Designation No. is CN0007.



2 GENERAL INFORMATION

2.1 GENERAL DESCRIPTION OF EUT

PRODUCT	Electron	
BRAND NAME	Particle	
MODEL NAME	ELC402, ELC404	
POWER SUPPLY	DC 5V from Host Uint or DC3.7V from Li-ion battery Vnor=3.7V,Vmin=3.145V,Vmax=4.07V	
MODULATION TECHNOLOGY	DC 3.7V/3.145/4.07 by DC source	QPSK
FREQUENCY RANGE	DC 3.7V by battery	699.7MHz ~ 715.3MHz
	DC 3.7V by battery	700.5MHz ~ 714.5MHz
	DC 3.7V by battery	701.5MHz ~ 713.5MHz
	DC 3.7V by battery	704.0MHz ~ 711.0MHz
	DC 3.7V by battery	779.5MHz ~ 784.5MHz
	LTE Band 13 Channel Bandwidth: 10MHz	782.0MHz
EMISSION DESIGNATOR	LTE Band 12 Channel Bandwidth: 1.4MHz	QPSK:1M09G7D
	LTE Band 12 Channel Bandwidth: 3MHz	QPSK:2M69G7D
	LTE Band 12 Channel Bandwidth: 5MHz	QPSK:4M47G7D
	LTE Band 12 Channel Bandwidth: 10MHz	QPSK:8M94G7D
	LTE Band 13 Channel Bandwidth: 5MHz	QPSK:4M48G7D
	LTE Band 13 Channel Bandwidth: 10MHz	QPSK:8M92G7D
	LTE Band 12 Channel Bandwidth: 1.4MHz	269mW
MAX. ERP/EIRP POWER	LTE Band 12 Channel Bandwidth: 3MHz	272mW
	LTE Band 12 Channel Bandwidth: 5MHz	275mW
	LTE Band 12 Channel Bandwidth: 10MHz	277mW
	LTE Band 13 Channel Bandwidth: 5MHz	274mW
	LTE Band 13 Channel Bandwidth: 10MHz	270mW
	ANTENNA TYPE	Fixed External Antenna with 1.4dBi
HW VERSION	V007	
SW VERSION	V1.4.0	



ACCESSORY DEVICE	Refer to user's manual
DATA CABLE	N/A

NOTE:

1. For a more detailed features description, please refer to the manufacturer's specifications or the user's manual.
2. The schematic and PCB of the ELC404 is completely the same with ELC402, and these two models of HW&SW is the same. Because changing the MVNO's E-SIM card (embedded SIM card) provider from Kore to Twilio, so we plan to use different model name to sell it in market. The differences are as follows:ELC402 uses eSIM of Kore.ELC404 uses eSIM of Twilio.
3. For the test results, the EUT had been tested with all conditions. But only the worst case was shown in test report.
4. The EUT incorporates a SISO function. Physically, the EUT provides one completed transmitter and one receiver.

MODULATION MODE	TX FUNCTION
LTE	1TX/1RX



2.2 CONFIGURATION OF SYSTEM UNDER TEST

FOR RADIATION EMISSION TEST

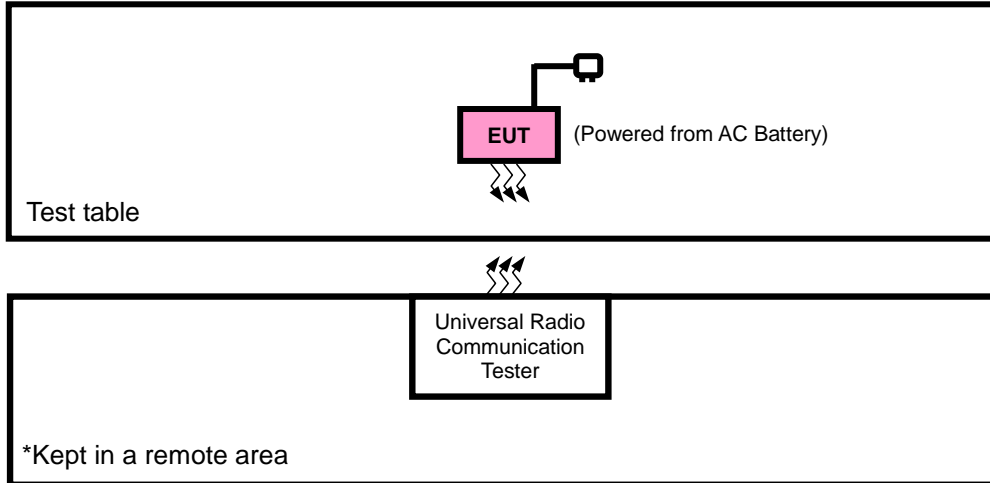



2.3 DESCRIPTION OF SUPPORT UNITS

The EUT has been tested as an independent unit together with other necessary accessories or support units. The following support units or accessories were used to form a representative test configuration during the tests.

NO.	PRODUCT	BRAND	MODEL NO.	SERIAL NO.	FCC ID
1	Battery	N/A	N/A	N/A	N/A
2	DC source	LONG WEI	PS-6403D	010934269	N/A

NO.	SIGNAL CABLE DESCRIPTION OF THE ABOVE SUPPORT UNITS
1	N/A
2	DC Line: Unshielded, Detachable 1.0m

NOTE:

1. All power cords of the above support units are non shielded (1.8m).

2.4 DESCRIPTION OF TEST MODES

Pre-Scan has been conducted to determine the worst-case mode from all possible combinations between available modulations, data rates, XYZ axis and antenna ports. The worst case in ERP/EIRP and radiated emission was found when positioned on X-plane for LTE. Following channel(s) was (were) selected for the final test as listed below:

EUT CONFIGURE MODE	DESCRIPTION
-	EUT + Battery with or LTE link



LTE BAND 12

TEST ITEM	AVAILABLE CHANNEL	TESTED CHANNEL	CHANNEL BANDWIDTH	MODULATION	MODE	
ERP	23017 to 23173	23017, 23095 , 23173	1.4MHz	QPSK	1 RB / 0 RB Offset	
	23025 to 23165	23025, 23095 ,23165	3MHz	QPSK	1 RB / 0 RB Offset	
	23035 to 23155	23035, 23095 ,23155	5MHz	QPSK	1 RB / 0 RB Offset	
	23060 to 23130	23060, 23095 ,23130	10MHz	QPSK	1 RB / 0 RB Offset	
FREQUENCY STABILITY	23017 to 23173	23017, 23173	1.4MHz	QPSK	1 RB / 0 RB Offset	
	23025 to 23165	23025, 23165	3MHz	QPSK	1 RB / 0 RB Offset	
	23035 to 23155	23035, 23155	5MHz	QPSK	1 RB / 0 RB Offset	
	23060 to 23130	23060, 23130	10MHz	QPSK	1 RB / 0 RB Offset	
OCCUPIED BANDWIDTH	23017 to 23173	23017, 23095 , 23173	1.4MHz	QPSK	6 RB / 0 RB Offset	
	23025 to 23165	23025, 23095 ,23165	3MHz	QPSK	15 RB / 0 RB Offset	
	23035 to 23155	23035, 23095 ,23155	5MHz	QPSK	25 RB / 0 RB Offset	
	23060 to 23130	23060, 23095 ,23130	10MHz	QPSK	50 RB / 0 RB Offset	
PEAK TO AVERAGE RATIO	23017 to 23173	23017, 23095 , 23173	1.4MHz	QPSK	1 RB / 0 RB Offset	
	23025 to 23165	23025, 23095 ,23165	3MHz	QPSK	1 RB / 0 RB Offset	
	23035 to 23155	23035, 23095 ,23155	5MHz	QPSK	1 RB / 0 RB Offset	
	23060 to 23130	23060, 23095 ,23130	10MHz	QPSK	1 RB / 0 RB Offset	
BAND EDGE	23017 to 23173	23017	1.4MHz	QPSK	1 RB / 0 RB Offset	
		23173	1.4MHz	QPSK	6 RB / 0 RB Offset	
	23025 to 23165	23025	3MHz	QPSK	1 RB / 5 RB Offset	
		23165	3MHz	QPSK	6 RB / 0 RB Offset	
	23035 to 23155	23035	5MHz	QPSK	1 RB / 0 RB Offset	
		23155	5MHz	QPSK	15 RB / 0 RB Offset	
	23060 to 23130	23060	10MHz	QPSK	1 RB / 14 RB Offset	
		23130	10MHz	QPSK	15 RB / 0 RB Offset	
	CONDCUDED EMISSION	23017 to 23173	23017, 23095 ,23173	1.4MHz	QPSK	1 RB / 0 RB Offset
		23025 to 23165	23025, 23095 ,23165	3MHz	QPSK	1 RB / 0 RB Offset
		23035 to 23155	23035, 23095 ,23155	5MHz	QPSK	1 RB / 0 RB Offset
		23060 to 23130	23060, 23095 ,23130	10MHz	QPSK	1 RB / 0 RB Offset
RADIATED EMISSION	23017 to 23173	23095	1.4MHz	QPSK	1 RB / 0 RB Offset	
	23025 to 23165	23095	3MHz	QPSK	1 RB / 0 RB Offset	
	23035 to 23155	23095	5MHz	QPSK	1 RB / 0 RB Offset	
	23060 to 23130	23060, 23095 ,23130	10MHz	QPSK	1 RB / 0 RB Offset	

Note: This device was tested under all bandwidths, RB configurations and modulations. The worst case was found in QPSK modulation.



LTE BAND 13

TEST ITEM	AVAILABLE CHANNEL	TESTED CHANNEL	CHANNEL BANDWIDTH	MODULATION	MODE	
ERP	23205 to 23255	23205, 23230, 23255	5MHz	QPSK	1 RB / 0 RB Offset	
	23230	23230	10MHz	QPSK	1 RB / 0 RB Offset	
FREQUENCY STABILITY	23205 to 23255	23205, 23255	5MHz	QPSK	1 RB / 0 RB Offset	
	23230	23230	10MHz	QPSK	1 RB / 0 RB Offset	
OCCUPIED BANDWIDTH	23205 to 23255	23205, 23230, 23255	5MHz	QPSK	25 RB / 0 RB Offset	
	23230	23230	10MHz	QPSK	50 RB / 0 RB Offset	
PEAK TO AVERAGE RATIO	23205 to 23255	23205, 23230, 23255	5MHz	QPSK	1 RB / 0 RB Offset	
	23230	23230	10MHz	QPSK	1 RB / 0 RB Offset	
BAND EDGE	23205 to 23255	23205	5MHz	QPSK	1 RB / 0 RB Offset 25 RB / 0 RB Offset	
		23255	5MHz	QPSK	1 RB / 24 RB Offset 25 RB / 0 RB Offset	
	23230	23230	10MHz	QPSK	1 RB / 0 RB Offset 50 RB / 0 RB Offset	
		23230	10MHz	QPSK	1 RB / 49 RB Offset 50 RB / 0 RB Offset	
	CONDCUDED EMISSION	23205 to 23255	23205, 23230, 23255	5MHz	QPSK	1 RB / 0 RB Offset
		23230	23230	10MHz	QPSK	1 RB / 0 RB Offset
RADIATED EMISSION	23205 to 23255	23205, 23230, 23255	5MHz	QPSK	1 RB / 0 RB Offset	
	23230	23230	10MHz	QPSK	1 RB / 0 RB Offset	

Note: This device was tested under all bandwidths, RB configurations and modulations. The worst case was found in QPSK modulation.

TEST CONDITION:

TEST ITEM	ENVIRONMENTAL CONDITIONS	INPUT POWER	TESTED BY
EIRP	24deg. C, 60%RH	DC 3.7V by battery	Star Le
FREQUENCY STABILITY	24deg. C, 61%RH	DC 3.7V/3.145/4.07 by DC source	Big Wang
OCCUPIED BANDWIDTH	24deg. C, 61%RH	DC 3.7V by battery	Big Wang
PEAK TO AVERAGE RATIO	24deg. C, 61%RH	DC 3.7V by battery	Big Wang
BAND EDGE	24deg. C, 61%RH	DC 3.7V by battery	Big Wang
CONDCUDED EMISSION	24deg. C, 61%RH	DC 3.7V by battery	Big Wang
RADIATED EMISSION	23deg. C, 70%RH	DC 3.7V by battery	Star Le



2.5 GENERAL DESCRIPTION OF APPLIED STANDARDS

The EUT is a RF product. According to the specifications of the manufacturer, it must comply with the requirements of the following standards:

Canada RSS-130, Issue 2, February 2019

Canada RSS-Gen, Issue 5, Amendment 1, March 2019

ANSI C63.26 - 2015

NOTE: All test items have been performed and recorded as per the above standards.

2.6 TRANSMIT ANTENNA

The applicant for equipment certification shall provide a list of all antenna types that may be used with the transmitter, where applicable (i.e. for transmitters with detachable antenna), indicating the maximum permissible antenna gain (in dBi) and the required impedance for each antenna. The test report shall demonstrate the compliance of the transmitter with the limit for maximum equivalent isotropically radiated power (e.i.r.p.) specified in the applicable RSS, when the transmitter is equipped with any antenna type, selected from this list.

Antenna Type	Fixed External Antenna
Antenna Gain	1.4dBi
Impedance	50 Ω



3 TEST TYPES AND RESULTS

3.1 OUTPUT POWER MEASUREMENT

3.1.1 LIMITS OF OUTPUT POWER MEASUREMENT

For frequency bands 617-652MHz and 663-698MHz:

The e.r.p. shall not exceed 3 watts for mobile equipment, fixed subscriber equipment and portable equipment.

For frequency bands 698-756MHz and 777-787MHz:

The e.r.p. shall not exceed 30 watts for mobile equipment and outdoor fixed subscriber equipment. The e.r.p. shall not exceed 3 watts for portable equipment and indoor fixed subscriber equipment.

3.1.2 TEST PROCEDURES

ERP MEASUREMENT:

Per KDB 971168 D01 Power Meas License Digital Systems v03r01 or subclause 5.2.5.5 of ANSI C63.26-2015, the relevant equation for determining the ERP or EIRP from the conducted RF output power measured using the guidance provided above is:

$$\text{ERP or EIRP} = P_{\text{Meas}} + G_{\text{T}} - L_{\text{C}}$$

Where:

ERP or EIRP = effective radiated power or equivalent isotropically radiated power, respectively

(expressed in the same units as P_{Meas} , typically dBW or dBm);

P_{Meas} = measured transmitter output power or PSD, in dBm or dBW;

G_{T} = gain of the transmitting antenna, in dBd (ERP) or dBi (EIRP);

L_{C} = signal attenuation in the connecting cable between the transmitter and antenna, in dB.

$$\text{ERP} = \text{EIRP} - 2.15$$

CONDUCTED POWER MEASUREMENT:

- The EUT was set up for the maximum power with LTE link data modulation and link up with simulator.
- Set the EUT to transmit under low, middle and high channel and record the power level shown on simulator.



3.1.3 TEST SETUP

CONDUCTED POWER MEASUREMENT:

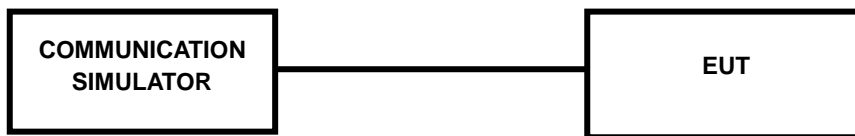



3.1.4 TEST RESULTS

AVERAGE CONDUCTED OUTPUT POWER (dBm)

LTE Band 12

BW	Modulation	RB Size	RB Offset	Low CH 23017	Mid CH 23095	High CH 23173	3GPP MPR (dB)
				Frequency 699.7 MHz	Frequency 707.5 MHz	Frequency 715.3 MHz	
12/1.4	QPSK	1	0	23.45	23.39	23.43	0
		1	5	23.35	23.31	23.38	0
		3	0	23.38	23.22	23.39	0
		3	3	23.43	23.37	23.41	0
		6	0	23.33	23.29	23.36	0

BW	Modulation	RB Size	RB Offset	Low CH 23025	Mid CH 23095	High CH 23165	3GPP MPR (dB)
				Frequency 700.5 MHz	Frequency 707.5 MHz	Frequency 714.5 MHz	
12/3	QPSK	1	0	23.49	23.43	23.47	0
		1	5	23.39	23.35	23.42	0
		3	0	23.42	23.26	23.43	0
		3	3	23.48	23.33	23.40	1
		6	0	23.17	23.07	23.04	1

BW	Modulation	RB Size	RB Offset	Low CH 23035	Mid CH 23095	High CH 23155	3GPP MPR (dB)
				Frequency 701.5 MHz	Frequency 707.5 MHz	Frequency 713.5 MHz	
12/5	QPSK	1	0	23.55	23.49	23.53	0
		1	5	23.45	23.41	23.48	0
		3	0	23.48	23.32	23.49	0
		3	3	23.54	23.39	23.46	1
		6	0	23.23	23.13	23.10	1



BW	Modulation	RB Size	RB Offset	Low CH 23060	Mid CH 23095	High CH 23130	3GPP MPR (dB)
				Frequency 704 MHz	Frequency 707.5 MHz	Frequency 711 MHz	
12/10	QPSK	1	0	23.58	23.52	23.56	0
		1	5	23.48	23.44	23.51	0
		3	0	23.51	23.35	23.52	0
		3	3	23.57	23.42	23.49	1
		6	0	23.26	23.16	23.13	1

LTE Band 13

BW	Modulation	RB Size	RB Offset	Low CH 23205	Mid CH 23230	High CH 23255	3GPP MPR (dB)
				Frequency 779.5 MHz	Frequency 782.0MHz	Frequency 784.5 MHz	
13 / 5	QPSK	1	0	23.46	23.52	23.49	13 / 5
		1	5	23.42	23.48	23.45	
		3	0	23.43	23.49	23.46	
		3	3	23.37	23.43	23.40	
		6	0	23.26	23.32	23.29	

BW	Modulation	RB Size	RB Offset	CH	CH 23230	CH	3GPP MPR (dB)
				Frequency MHz	Frequency 782.0 MHz	Frequency MHz	
13 / 10	QPSK	1	0	-	23.57	-	0
		1	5	-	23.53	-	0
		3	0	-	23.54	-	0
		3	3	-	23.48	-	1
		6	0	-	23.37	-	1



ERP

LTE BAND 12

CHANNEL BANDWIDTH: 1.4MHz QPSK

Channel	Frequency (MHz)	Conducted Power (dBm)	G _T -L _c (dB)	EIRP (dBm)	EIRP (mW)	Limit (W)
23017	699.7	23.45	3.00	24.30	269.15	3
23095	707.5	23.39	3.00	24.24	265.46	3
23173	715.3	23.42	3.00	24.27	267.3	3

CHANNEL BANDWIDTH: 3MHz QPSK

Channel	Frequency (MHz)	Conducted Power (dBm)	G _T -L _c (dB)	EIRP (dBm)	EIRP (mW)	Limit (W)
23025	700.5	23.49	3.00	24.34	271.64	3
23095	707.5	23.43	3.00	24.28	267.92	3
23165	714.5	23.47	3.00	24.32	270.4	3

CHANNEL BANDWIDTH: 5MHz QPSK

Channel	Frequency (MHz)	Conducted Power (dBm)	G _T -L _c (dB)	EIRP (dBm)	EIRP (mW)	Limit (W)
23035	701.5	23.55	3.00	24.40	275.42	3
23095	707.5	23.49	3.00	24.34	271.64	3
23155	713.5	23.53	3.00	24.38	274.16	3

CHANNEL BANDWIDTH: 10MHz QPSK

Channel	Frequency (MHz)	Conducted Power (dBm)	G _T -L _c (dB)	EIRP (dBm)	EIRP (mW)	Limit (W)
23060	704.0	23.58	3.00	24.43	277.33	3
23095	707.5	23.52	3.00	24.37	273.53	3
23130	711.0	23.52	3.00	24.37	273.53	3



LTE BAND 13

CHANNEL BANDWIDTH: 5MHz QPSK

Channel	Frequency (MHz)	Conducted Power (dBm)	G _T -L _c (dB)	EIRP (dBm)	EIRP (mW)	Limit (W)
23205	779.5	23.46	3.00	24.31	269.77	3
23230	782.0	23.52	3.00	24.37	273.53	3
23255	784.5	23.49	3.00	24.34	271.64	3

CHANNEL BANDWIDTH: 10MHz QPSK

Channel	Frequency (MHz)	Conducted Power (dBm)	G _T -L _c (dB)	EIRP (dBm)	EIRP (mW)	Limit (W)
23230	782.0	23.47	3.00	24.32	270.4	3



3.2 FREQUENCY STABILITY MEASUREMENT

3.2.1 LIMITS OF FREQUENCY STABILITY MEASUREMENT

The frequency stability shall be sufficient to ensure that the fundamental emissions stay within the authorized bands of operation.

3.2.2 TEST PROCEDURE

- a. Device is placed at the oven room. The oven room could control the temperatures and humidity. Power warm up is at least 15 min and power applied should perform before recording frequency error.
- b. EUT is connected the external power supply to control the DC input power. The test voltage range is from minimum to maximum working voltage. Each step shall be record the frequency error rate.
- c. The temperature range step is 10 degrees in this test items. All temperature levels shall be hold the $\pm 0.5^{\circ}\text{C}$ during the measurement testing. The each temperature step shall be at least 0.5 hours, consider the EUT could be test under the stability condition.

NOTE: The frequency error was recorded frequency error from the communication simulator.

3.2.3 TEST SETUP

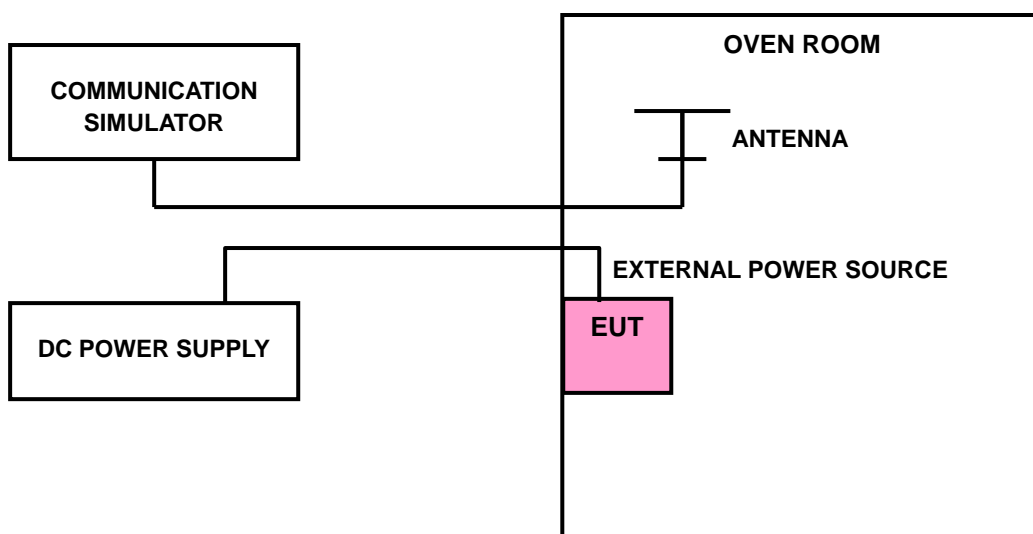



3.2.4 TEST RESULTS

LTE BAND 12

FREQUENCY ERROR VS. VOLTAGE

VOLTAGE (Volts)	1.4MHz		LIMIT (ppm)
	FREQUENCY ERROR (ppm)		
	Low Channel	High Channel	
V _{nor}	0.0021	0.0026	2.5
V _{min}	-0.0031	-0.0030	2.5
V _{max}	0.0021	0.0021	2.5

NOTE: The applicant defined the normal working voltage of the battery is from V_{min} to V_{dc}.

FREQUENCY ERROR vs. TEMPERATURE.

TEMP. (°C)	1.4MHz		LIMIT (ppm)
	FREQUENCY ERROR (ppm)		
	Low Channel	High Channel	
-30	-0.0114	-0.0115	2.5
-20	-0.0108	-0.0102	2.5
-10	-0.0082	-0.0084	2.5
0	-0.0076	-0.0076	2.5
10	-0.0049	-0.0045	2.5
20	-0.0043	-0.0041	2.5
30	-0.0039	-0.0033	2.5
40	-0.0018	-0.0015	2.5
50	-0.0002	-0.0003	2.5



FREQUENCY ERROR VS. VOLTAGE

VOLTAGE (Volts)	3MHz		LIMIT (ppm)
	FREQUENCY ERROR (ppm)		
	Low Channel	High Channel	
V _{nor}	0.0021	0.0021	2.5
V _{min}	-0.0022	-0.0025	2.5
V _{max}	0.0018	0.0018	2.5

NOTE: The applicant defined the normal working voltage of the battery is from V_{min} to V_{dc}.

FREQUENCY ERROR vs. TEMPERATURE.

TEMP. (°C)	3MHz		LIMIT (ppm)
	FREQUENCY ERROR (ppm)		
	Low Channel	High Channel	
-30	-0.0115	-0.0115	2.5
-20	-0.0110	-0.0106	2.5
-10	-0.0086	-0.0082	2.5
0	-0.0076	-0.0075	2.5
10	-0.0048	-0.0048	2.5
20	-0.0040	-0.0041	2.5
30	-0.0033	-0.0033	2.5
40	-0.0019	-0.0016	2.5
50	-0.0005	-0.0005	2.5



FREQUENCY ERROR VS. VOLTAGE

VOLTAGE (Volts)	5MHz		LIMIT (ppm)
	FREQUENCY ERROR (ppm)		
	Low Channel	High Channel	
V _{nor}	0.0021	0.0026	2.5
V _{min}	-0.0024	-0.0030	2.5
V _{max}	0.0021	0.0021	2.5

NOTE: The applicant defined the normal working voltage of the battery is from V_{min} to V_{dc}.

FREQUENCY ERROR vs. TEMPERATURE.

TEMP. (°C)	5MHz		LIMIT (ppm)
	FREQUENCY ERROR (ppm)		
	Low Channel	High Channel	
-30	-0.0117	-0.0117	2.5
-20	-0.0109	-0.0106	2.5
-10	-0.0085	-0.0080	2.5
0	-0.0074	-0.0073	2.5
10	-0.0053	-0.0045	2.5
20	-0.0042	-0.0042	2.5
30	-0.0039	-0.0033	2.5
40	-0.0015	-0.0020	2.5
50	-0.0004	-0.0002	2.5



FREQUENCY ERROR VS. VOLTAGE

VOLTAGE (Volts)	10MHz		LIMIT (ppm)
	FREQUENCY ERROR (ppm)		
	Low Channel	High Channel	
V _{nor}	0.0024	0.0024	2.5
V _{min}	-0.0030	-0.0030	2.5
V _{max}	0.0027	0.0024	2.5

NOTE: The applicant defined the normal working voltage of the battery is from V_{min} to V_{dc}.

FREQUENCY ERROR vs. TEMPERATURE.

TEMP. (°C)	10MHz		LIMIT (ppm)
	FREQUENCY ERROR (ppm)		
	Low Channel	High Channel	
-30	-0.0120	-0.0119	2.5
-20	-0.0106	-0.0107	2.5
-10	-0.0082	-0.0082	2.5
0	-0.0077	-0.0076	2.5
10	-0.0056	-0.0047	2.5
20	-0.0044	-0.0038	2.5
30	-0.0030	-0.0037	2.5
40	-0.0015	-0.0020	2.5
50	-0.0002	-0.0004	2.5



LTE BAND 13

FREQUENCY ERROR VS. VOLTAGE

VOLTAGE (Volts)	5MHz		LIMIT (ppm)
	FREQUENCY ERROR (ppm)		
	Low Channel	High Channel	
V _{nor}	0.0022	0.0026	2.5
V _{min}	-0.0023	-0.0030	2.5
V _{max}	0.0021	0.0021	2.5

NOTE: The applicant defined the normal working voltage of the battery is from V_{min} to V_{dc}.

FREQUENCY ERROR vs. TEMPERATURE.

TEMP. (°C)	5MHz		LIMIT (ppm)
	FREQUENCY ERROR (ppm)		
	Low Channel	High Channel	
-30	-0.0116	-0.0113	2.5
-20	-0.0105	-0.0110	2.5
-10	-0.0084	-0.0084	2.5
0	-0.0075	-0.0076	2.5
10	-0.0047	-0.0046	2.5
20	-0.0045	-0.0044	2.5
30	-0.0033	-0.0032	2.5
40	-0.0021	-0.0017	2.5
50	-0.0005	-0.0005	2.5



FREQUENCY ERROR VS. VOLTAGE

VOLTAGE (Volts)	10MHz		LIMIT (ppm)
	FREQUENCY ERROR (ppm)		
	Low Channel	High Channel	
V _{nor}	0.0025	0.0025	2.5
V _{min}	-0.0031	-0.0030	2.5
V _{max}	0.0024	0.0024	2.5

NOTE: The applicant defined the normal working voltage of the battery is from V_{min} to V_{dc}.

FREQUENCY ERROR vs. TEMPERATURE.

TEMP. (°C)	10MHz		LIMIT (ppm)
	FREQUENCY ERROR (ppm)		
	Low Channel	High Channel	
-30	-0.0121	-0.0111	2.5
-20	-0.0107	-0.0110	2.5
-10	-0.0086	-0.0083	2.5
0	-0.0076	-0.0075	2.5
10	-0.0053	-0.0052	2.5
20	-0.0040	-0.0043	2.5
30	-0.0037	-0.0028	2.5
40	-0.0022	-0.0022	2.5
50	-0.0005	-0.0005	2.5



3.3 OCCUPIED BANDWIDTH MEASUREMENT

3.3.1 LIMITS OF OCCUPIED BANDWIDTH MEASUREMENT

The width of a frequency band such that, below the lower and above the upper frequency limits, the mean powers emitted are each equal to a specified percentage 0.5 %of the total mean power of a given emission.

3.3.2 TEST SETUP

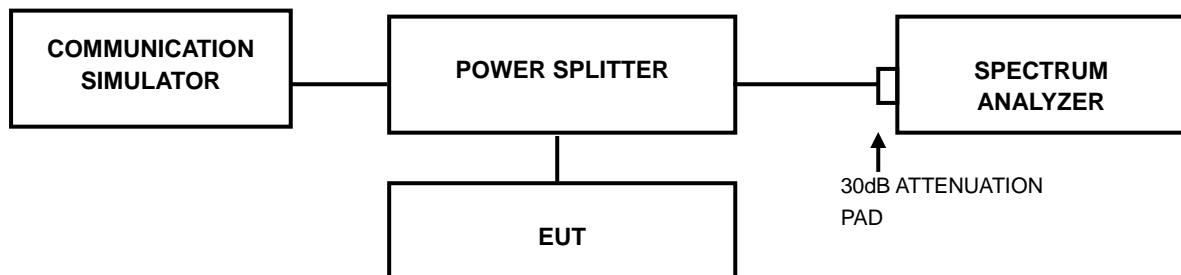

3.3.3 TEST PROCEDURES

- The conducted occupied bandwidth used the power splitter via EUT RF power connector between simulation base station and spectrum analyzer.
- Use OBW measurement function of Spectrum analyzer to measure 99 % occupied bandwidth.



3.3.4 TEST RESULTS

LTE BAND 12

CHANNEL BANDWIDTH:1.4MHz			
CHANNEL	Frequency (MHz)	99% OCCUPIED Bandwidth (MHz)	26 dB bandwidth (MHz)
		QPSK	QPSK
23017	699.7	1.10	1.21
23095	707.5	1.10	1.22
23173	715.3	1.09	1.21

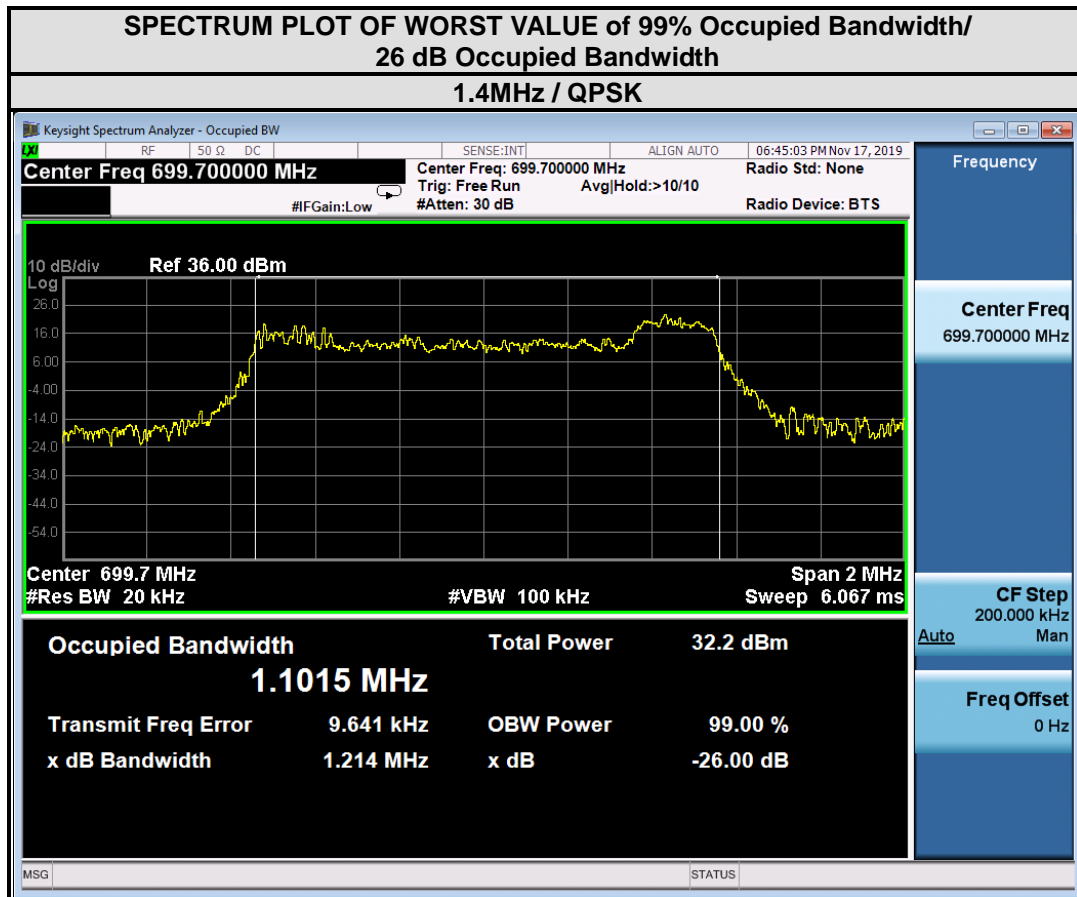



CHANNEL BANDWIDTH:3MHz			
CHANNEL	Frequency (MHz)	99% OCCUPIED Bandwidth (MHz)	26 dB bandwidth (MHz)
		QPSK	QPSK
23025	700.5	1.27	1.37
23095	707.5	1.27	1.45
23165	714.5	1.26	1.38

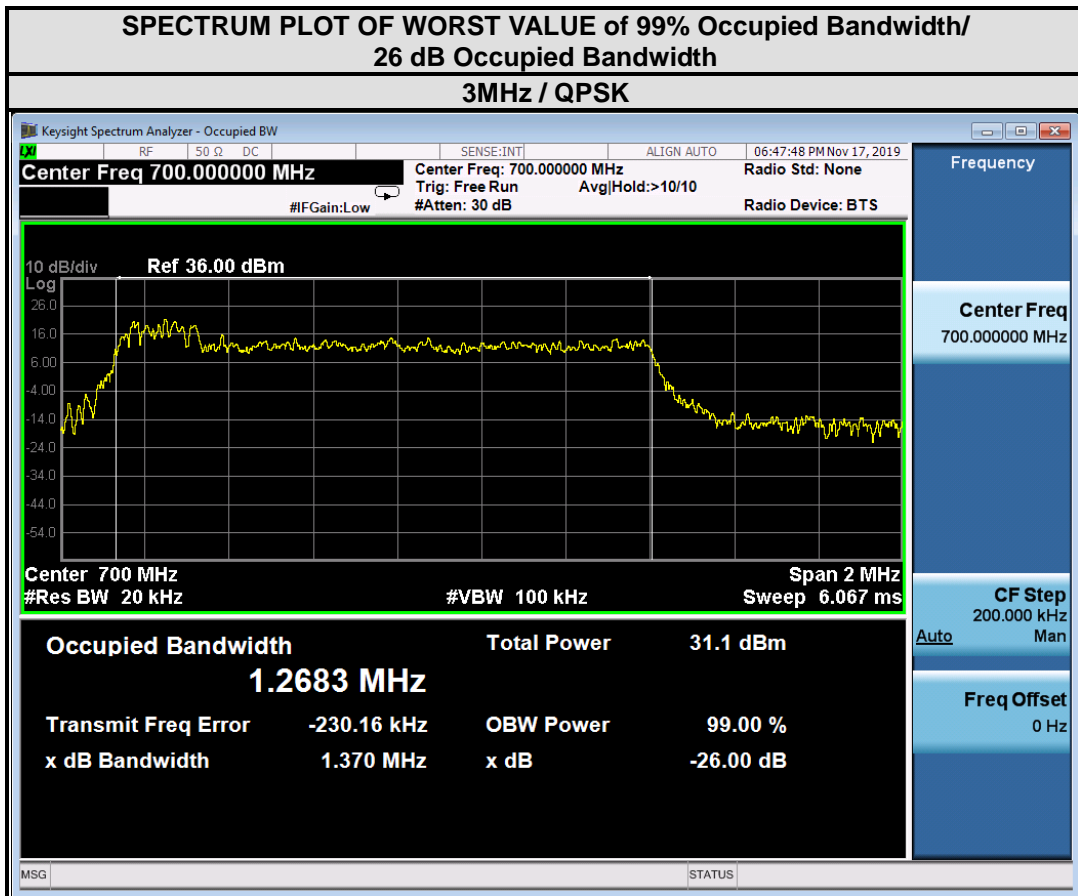



CHANNEL BANDWIDTH:5MHz			
CHANNEL	Frequency (MHz)	99% OCCUPIED Bandwidth (MHz)	26 dB bandwidth (MHz)
		QPSK	QPSK
23035	701.5	1.09	1.38
23095	707.5	1.09	1.31
23155	713.5	1.09	1.30

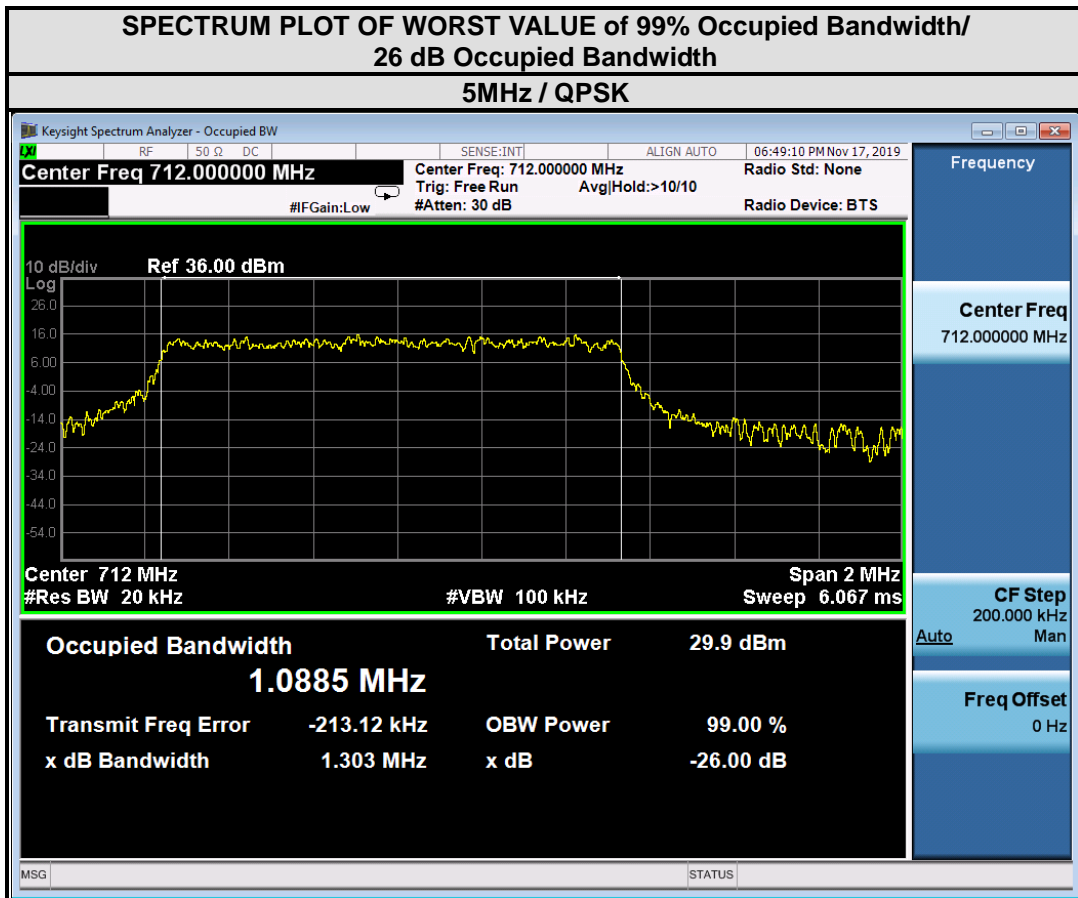



CHANNEL BANDWIDTH:10MHz			
CHANNEL	Frequency (MHz)	99% OCCUPIED Bandwidth (MHz)	26 dB bandwidth (MHz)
		QPSK	QPSK
23060	704	1.08	1.42
23095	707.5	1.09	1.47
23130	711	1.09	1.43

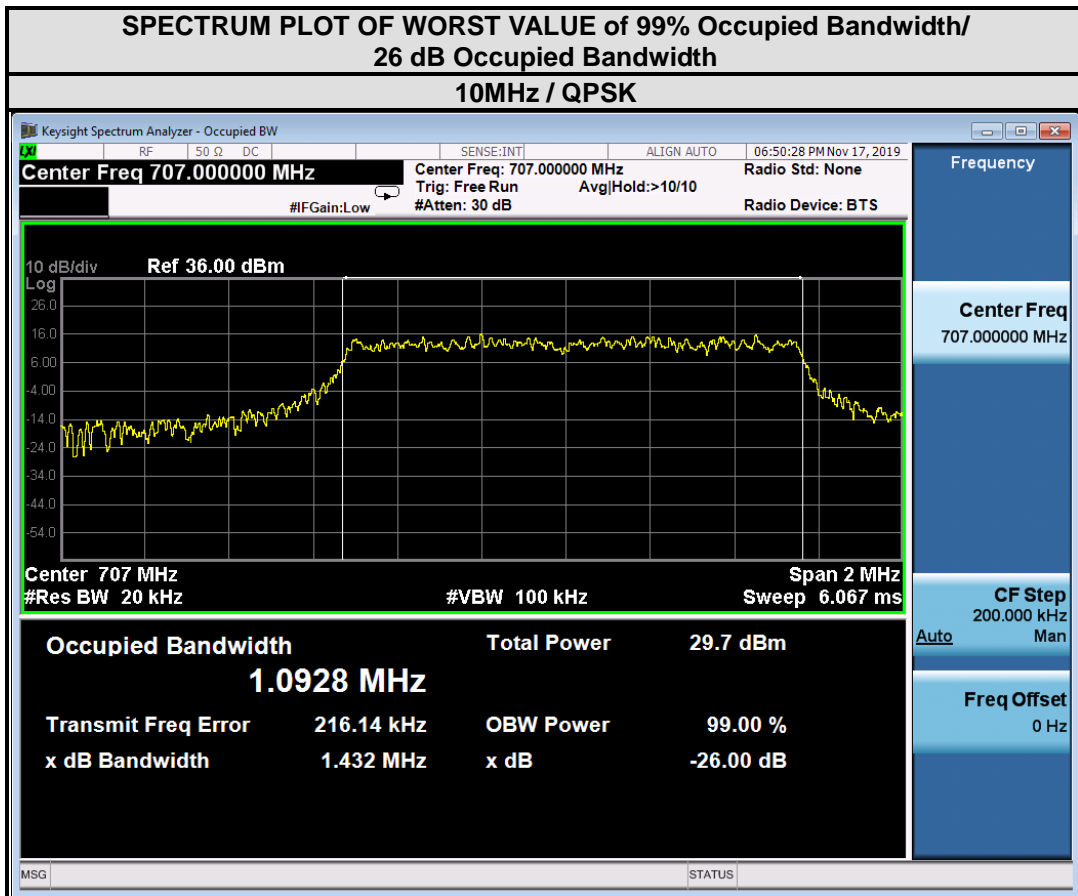



LTE BAND 13

CHANNEL BANDWIDTH:5MHz			
CHANNEL	Frequency (MHz)	99% OCCUPIED Bandwidth (MHz)	26 dB bandwidth (MHz)
		QPSK	QPSK
23205	779.5	1.08	1.34
23230	793	1.09	1.33
23255	784.5	1.08	1.33

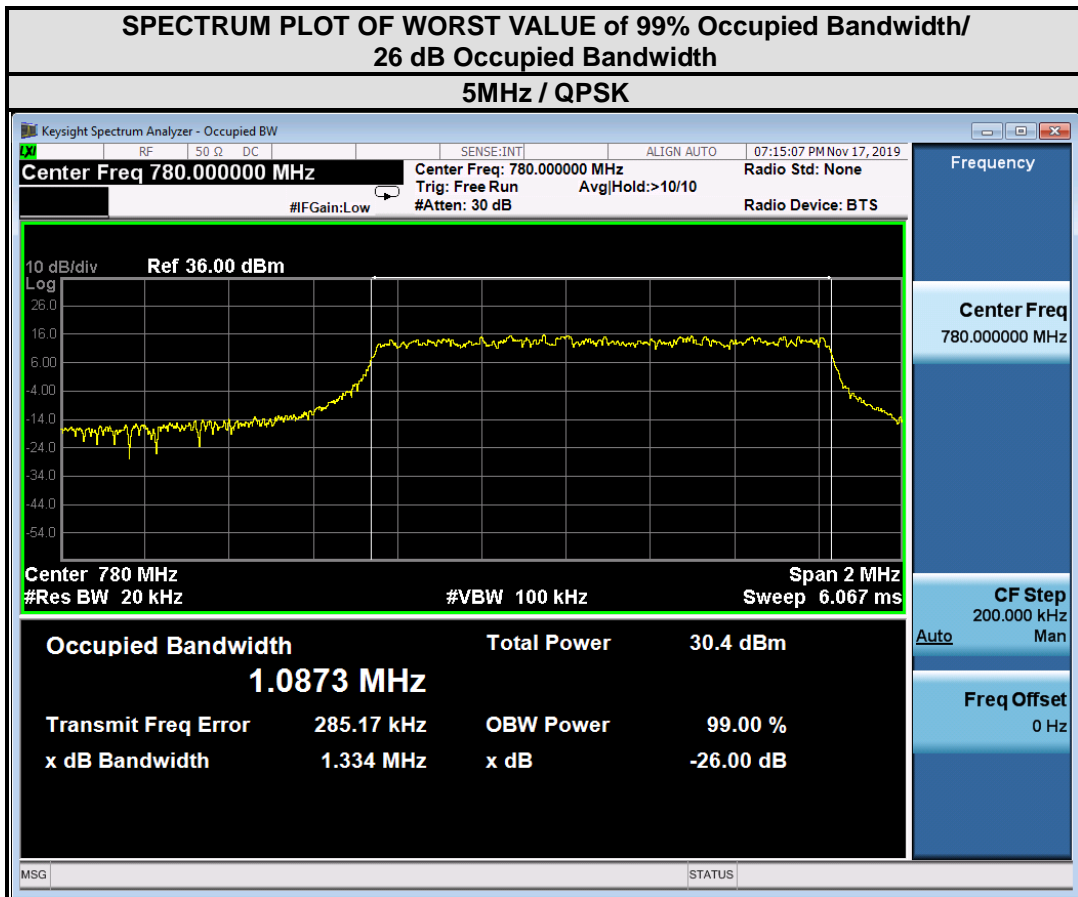



CHANNEL BANDWIDTH:10MHz			
CHANNEL	Frequency (MHz)	99% OCCUPIED Bandwidth (MHz)	26 dB bandwidth (MHz)
		QPSK	QPSK
23230	782	1.08	1.40

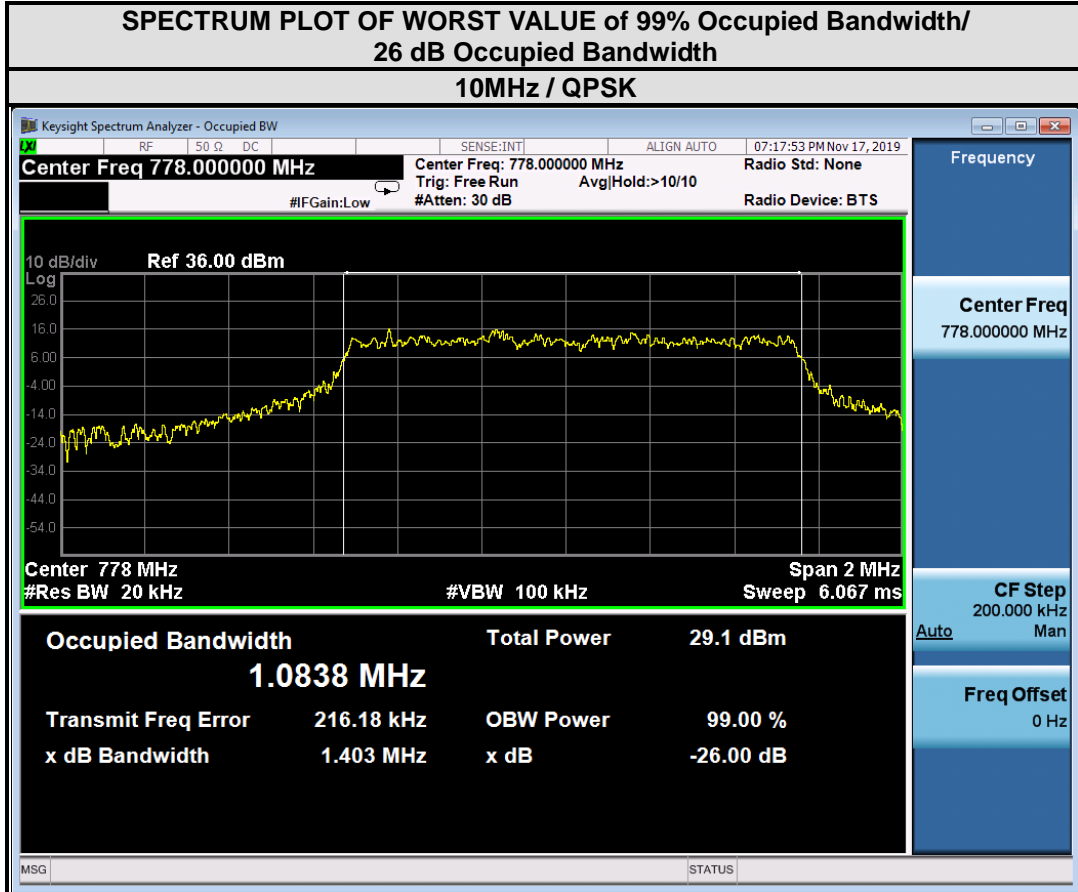



3.4 PEAK TO AVERAGE RATIO

3.4.1 LIMITS OF PEAK TO AVERAGE RATIO MEASUREMENT

In measuring transmissions in this band using an average power technique, the peak to-average ratio (PAR) of the transmission may not exceed 13 dB

3.4.2 TEST SETUP

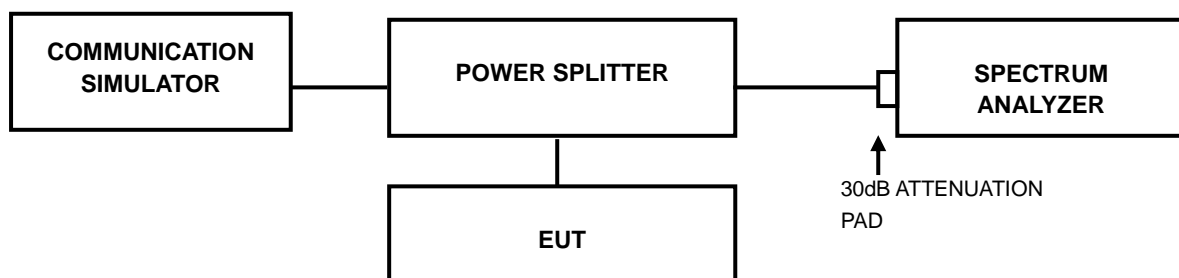

3.4.3 TEST PROCEDURES

1. Set resolution/measurement bandwidth \geq signal's occupied bandwidth;
2. Set the number of counts to a value that stabilizes the measured CCDF curve;
3. Record the maximum PAPR level associated with a probability of 0.1%.



3.4.4 TEST RESULTS

LTE BAND 12

CHANNEL BANDWIDTH: 1.4MHz			
CHANNEL	Frequency (MHz)	PEAK TO AVERAGE RATIO (dB)	
		QPSK	
23017	699.7	4.36	
23095	707.5	4.38	
23173	715.3	4.43	

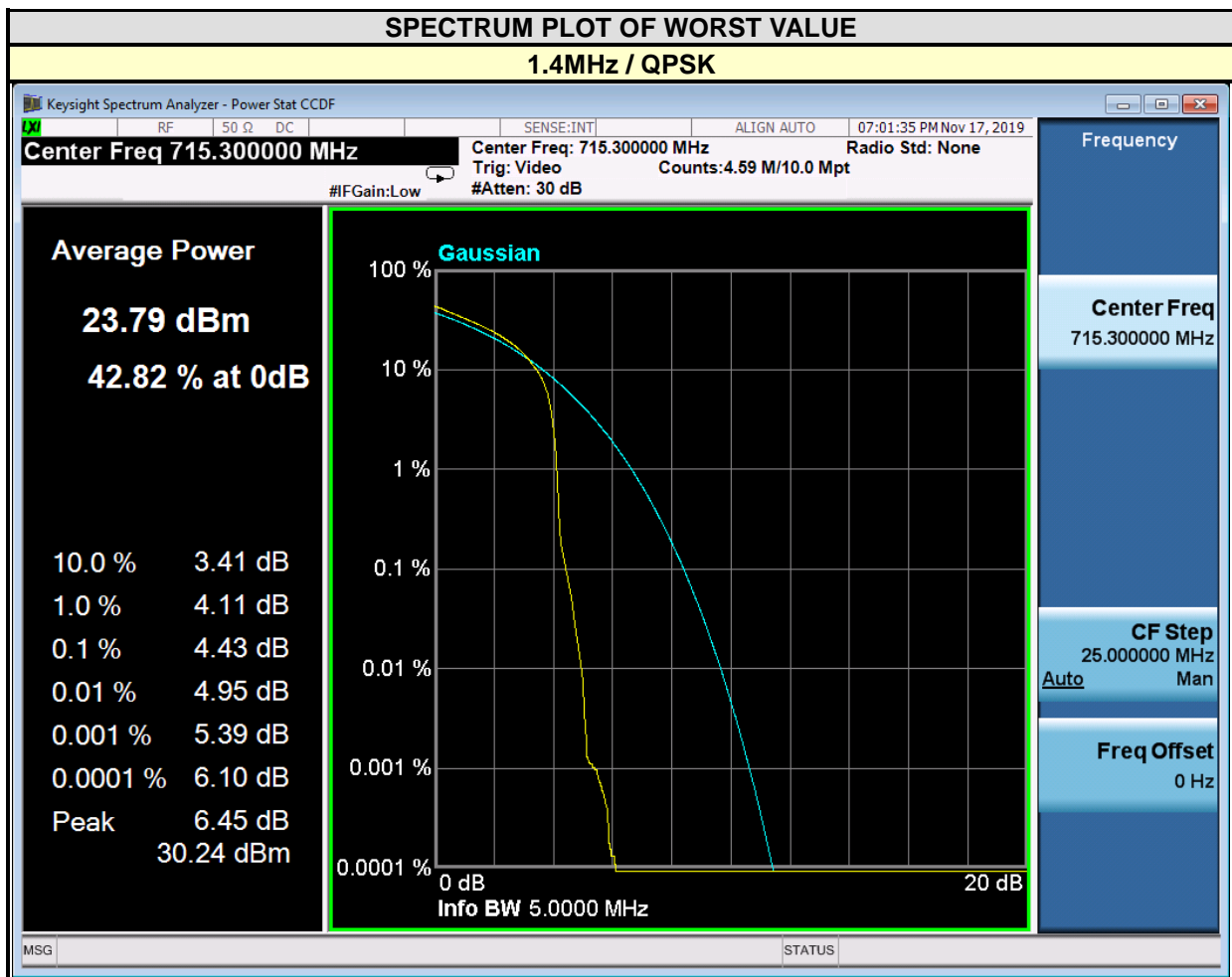



CHANNEL BANDWIDTH: 3MHz		
CHANNEL	Frequency (MHz)	PEAK TO AVERAGE RATIO (dB)
		QPSK
23025	700.5	3.89
23095	707.5	4.15
23165	714.5	3.88

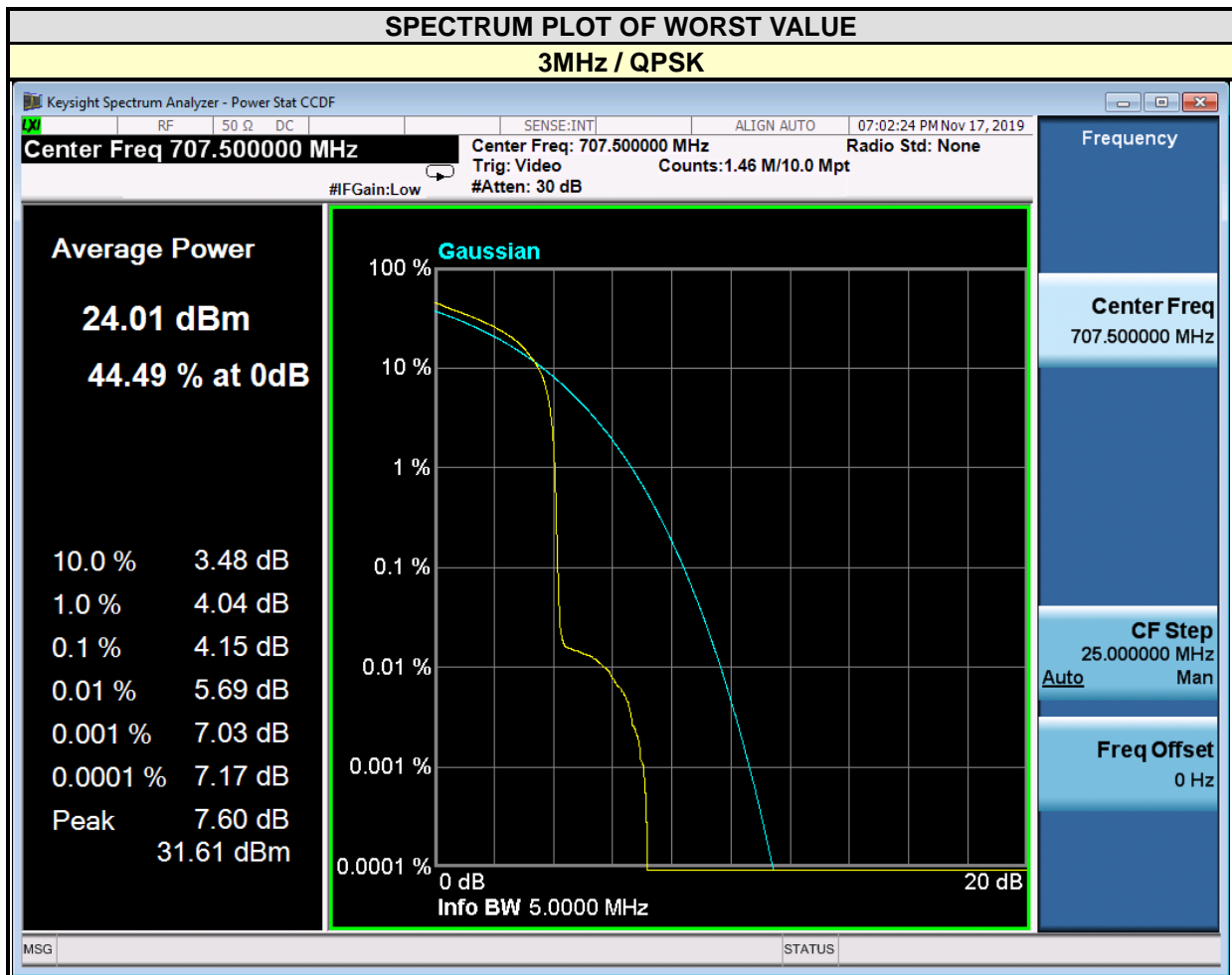



CHANNEL BANDWIDTH: 5MHz		
CHANNEL	Frequency (MHz)	PEAK TO AVERAGE RATIO (dB)
		QPSK
23035	701.5	4.68
23095	707.5	4.85
23155	713.5	4.61

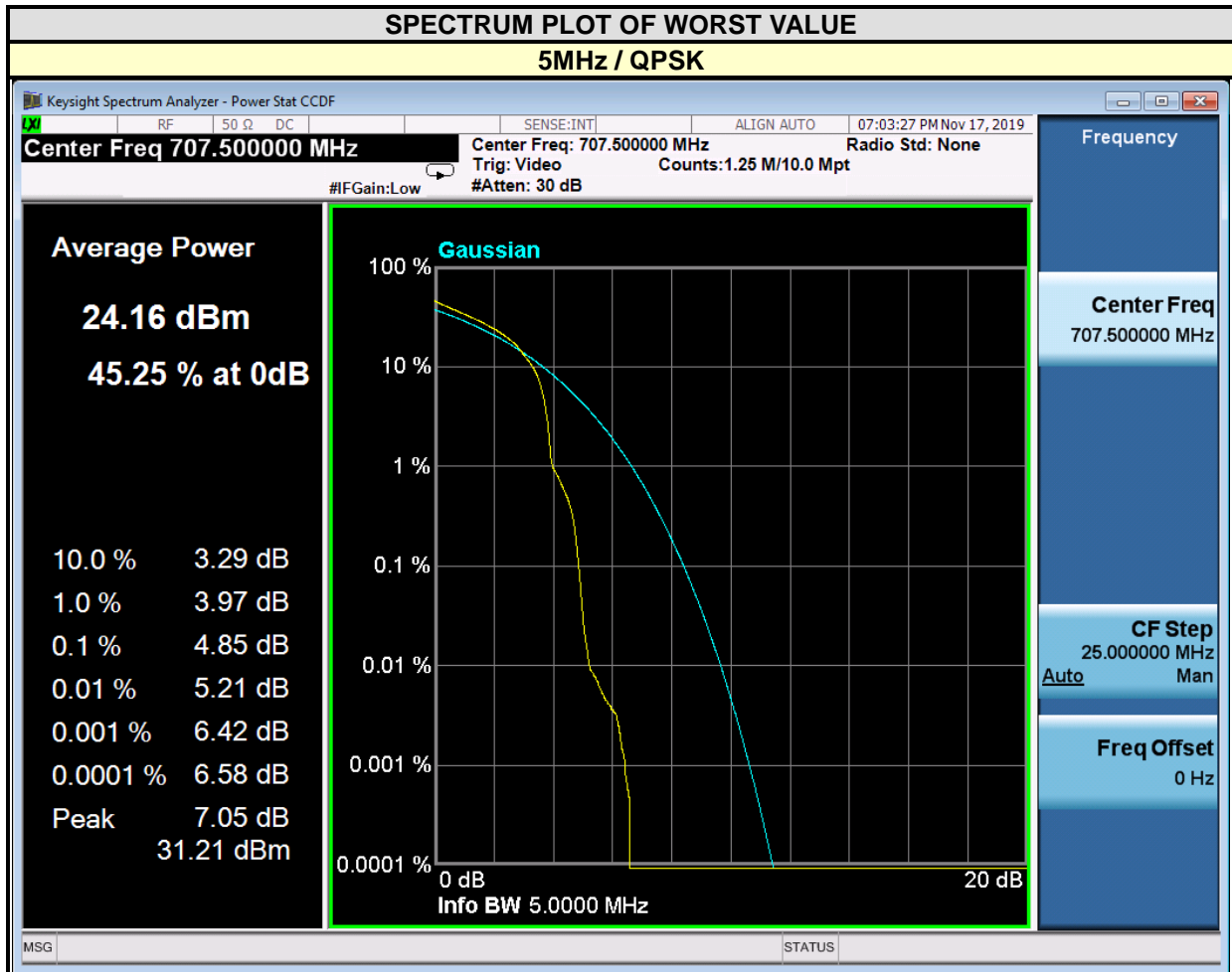



CHANNEL BANDWIDTH: 10MHz		
CHANNEL	Frequency (MHz)	PEAK TO AVERAGE RATIO (dB)
		QPSK
23060	704	4.62
23095	707.5	4.84
23130	711	4.61

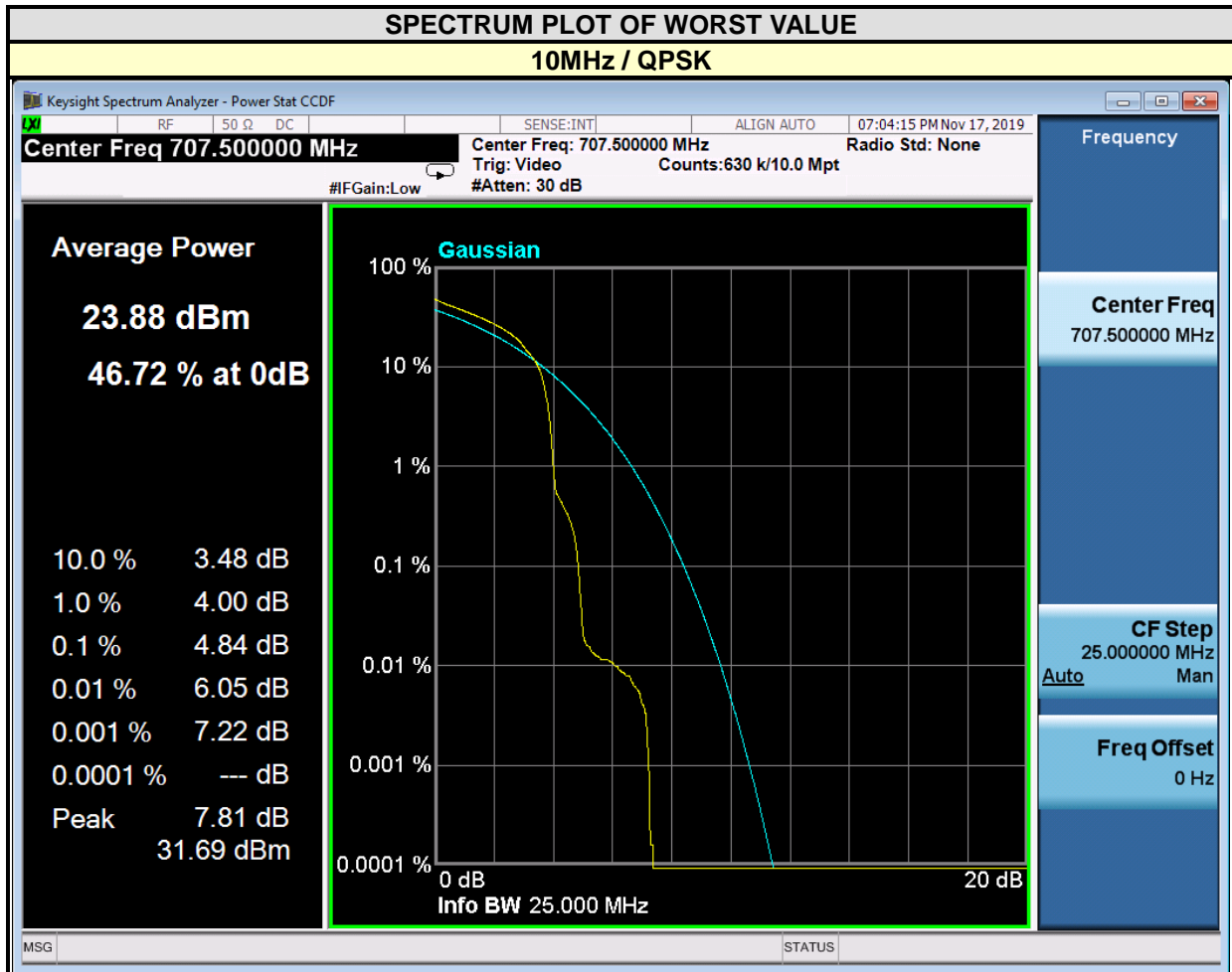



LTE BAND 13

CHANNEL BANDWIDTH: 5MHz		
CHANNEL	Frequency (MHz)	PEAK TO AVERAGE RATIO (dB)
		QPSK
23205	779.5	3.62
23230	793	3.82
23255	784.5	4.02

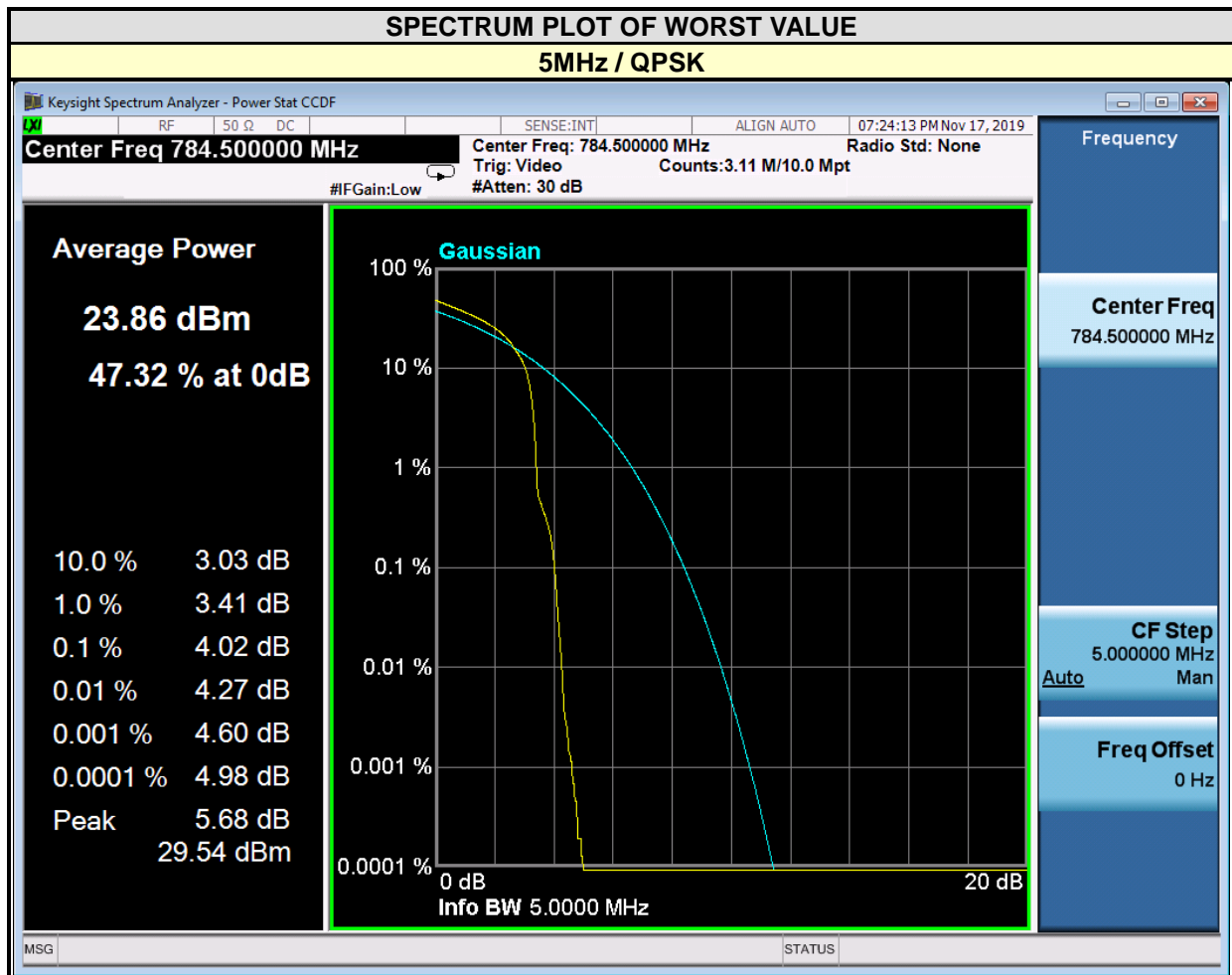



CHANNEL BANDWIDTH: 10MHz		
CHANNEL	Frequency (MHz)	PEAK TO AVERAGE RATIO (dB)
		QPSK
23230	782	3.85

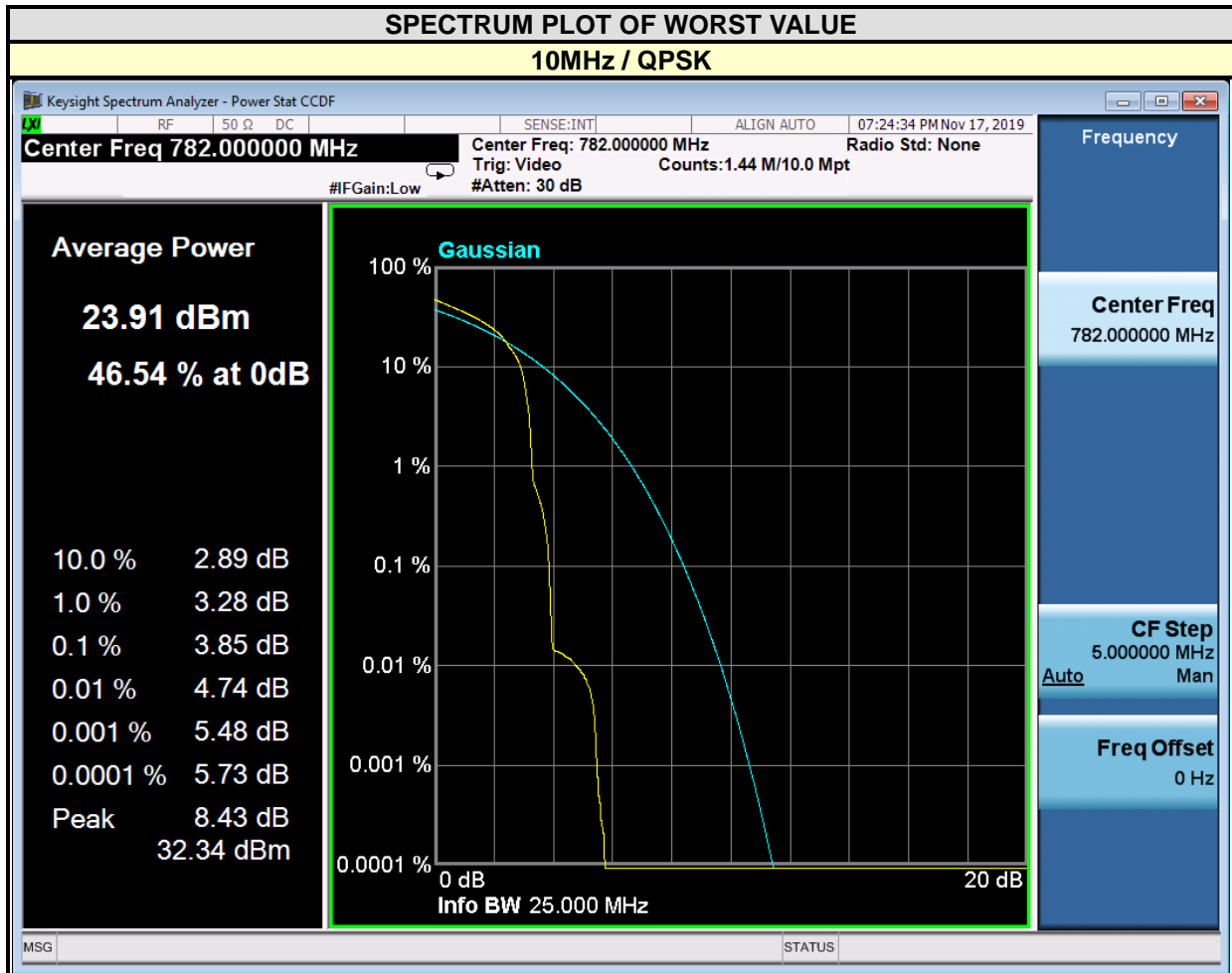



3.5 BAND EDGE MEASUREMENT

3.5.1 LIMITS OF BAND EDGE MEASUREMENT

The power of any emission outside a licensee's frequency band(s) of operation shall be attenuated below the transmitter power (P) within the licensed band(s) of operation, measured in watts, by at least $43 + 10 \log (P)$ dB. Compliance with this provision is based on the use of measurement instrumentation employing a resolution bandwidth of 100 kilohertz or greater.

However, in the 100 kilohertz bands immediately outside and adjacent to a licensee's frequency block, a resolution bandwidth of at least 30 kHz may be employed.

3.5.2 TEST SETUP

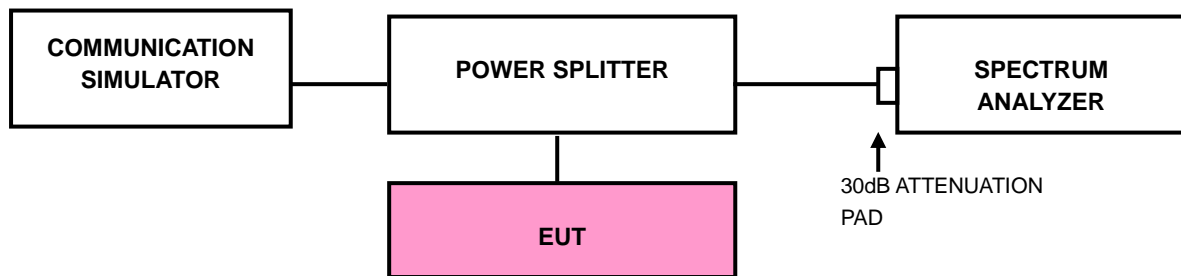



3.5.3 TEST PROCEDURES

- a. The EUT was set up for the maximum peak power with LTE link data modulation. The power was measured with R&S Spectrum Analyzer. All measurements were done at 2 channels (low and high operational frequency range.).
- b. The band edge measurement used the power splitter via EUT RF power connector between simulation base station and spectrum analyzer.
- c. The center frequency of spectrum is the band edge frequency and span is 1~5 MHz. RBW of the spectrum is 20kHz and VBW of the spectrum is 100 kHz. (LTE bandwidth 1.4MHz)
- d. The center frequency of spectrum is the band edge frequency and span is 1~5 MHz. RBW of the spectrum is 30kHz and VBW of the spectrum is 100kHz. (LTE bandwidth 3MHz)
- e. The center frequency of spectrum is the band edge frequency and span is 1~5 MHz. RBW of the spectrum is 50kHz and VBW of the spectrum is 200kHz. (LTE bandwidth 5MHz)
- f. The center frequency of spectrum is the band edge frequency and span is 1~5 MHz. RBW of the spectrum is 100kHz and VBW of the spectrum is 300kHz. (LTE bandwidth 10MHz)
- g. The center frequency of spectrum is the band edge frequency and span is 1~5 MHz. RBW of the spectrum is 200kHz and VBW of the spectrum is 1MHz. (LTE bandwidth 15MHz)
- h. The center frequency of spectrum is the band edge frequency and span is 1~5 MHz. RBW of the spectrum is 200kHz and VBW of the spectrum is 1MHz. (LTE bandwidth 20MHz)
- i. Record the max trace plot into the test report.



3.5.4 TEST RESULTS

LTE BAND 12

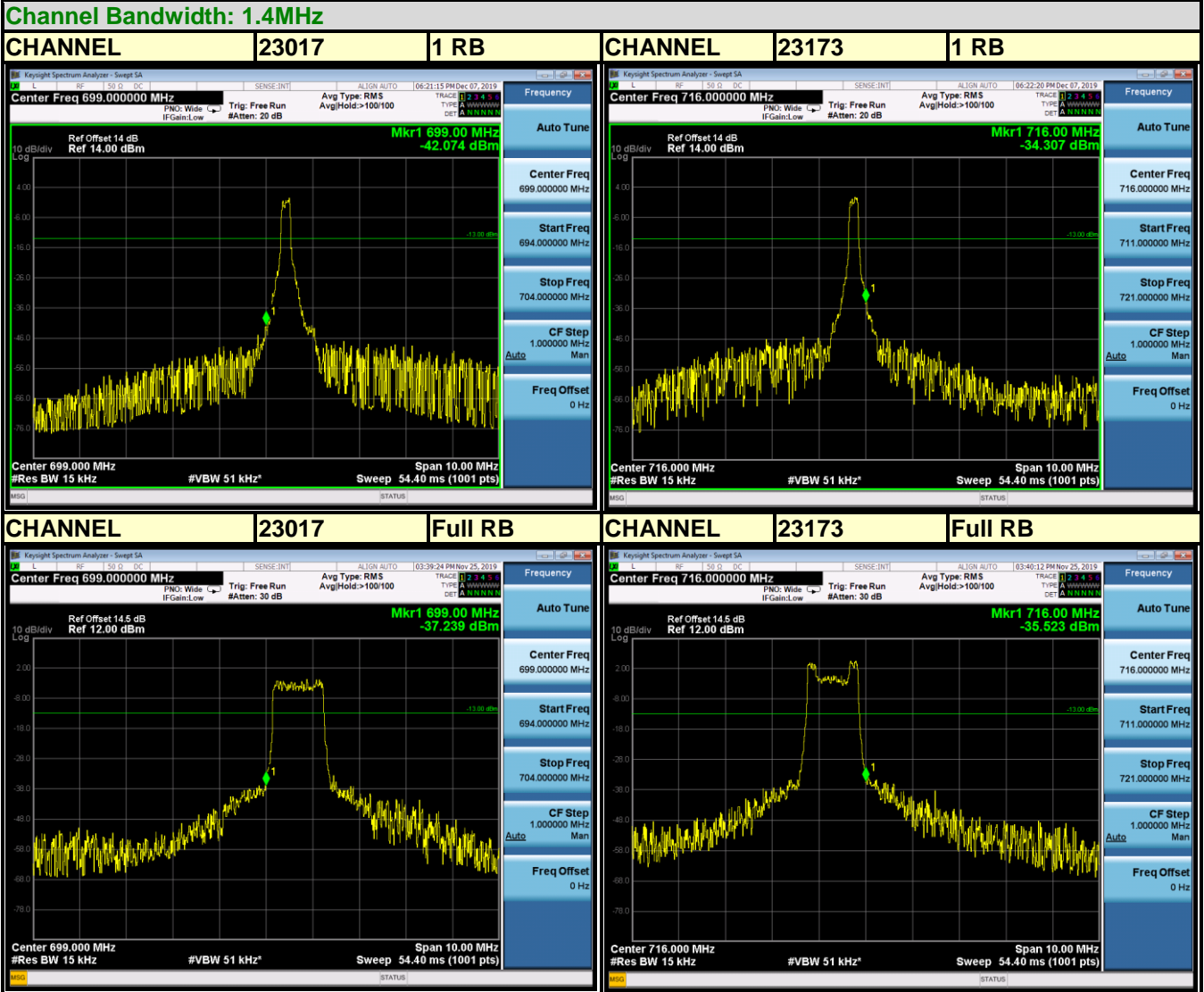

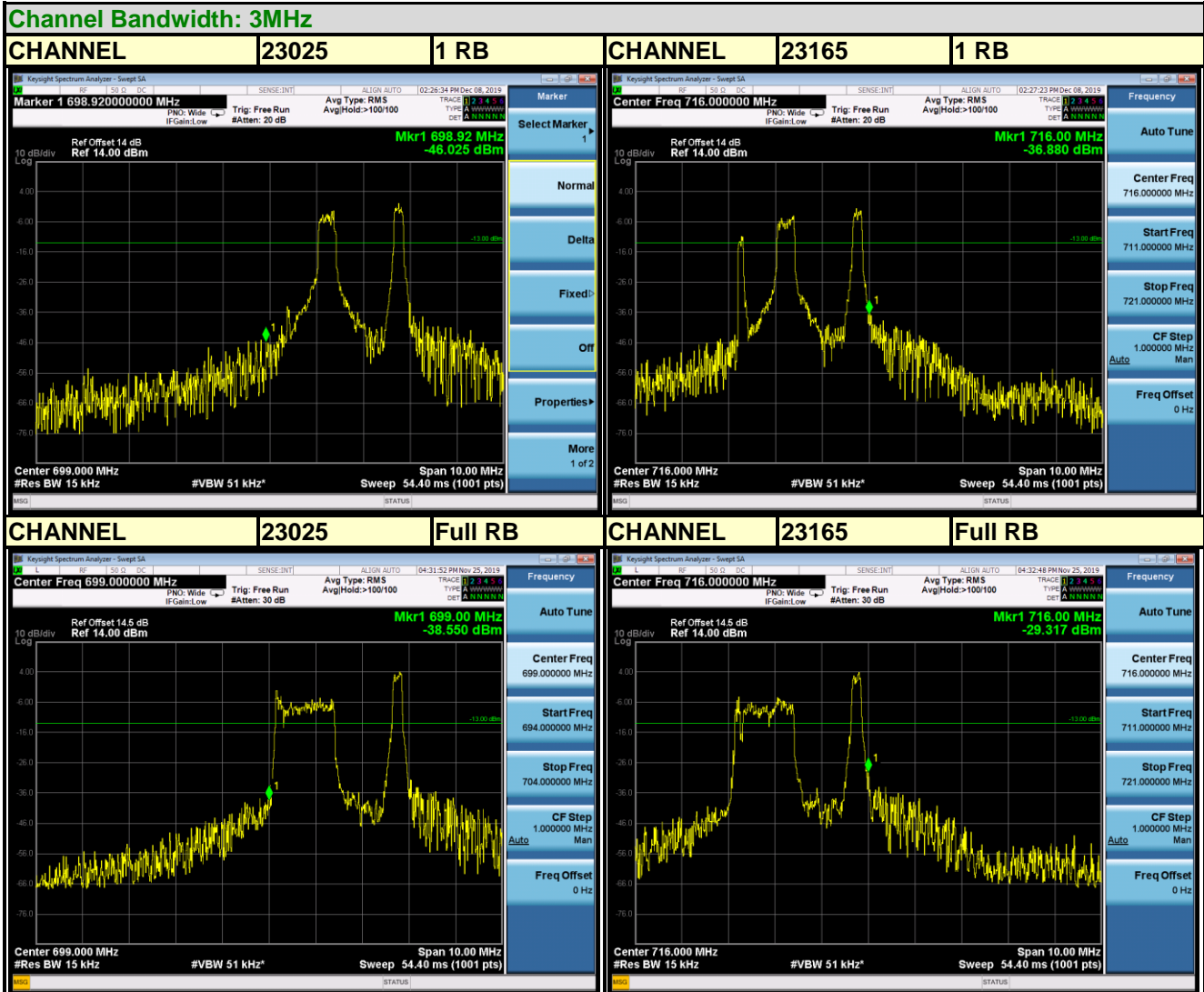



BUREAU VERITAS

Test Report No.: ICP20120029-4

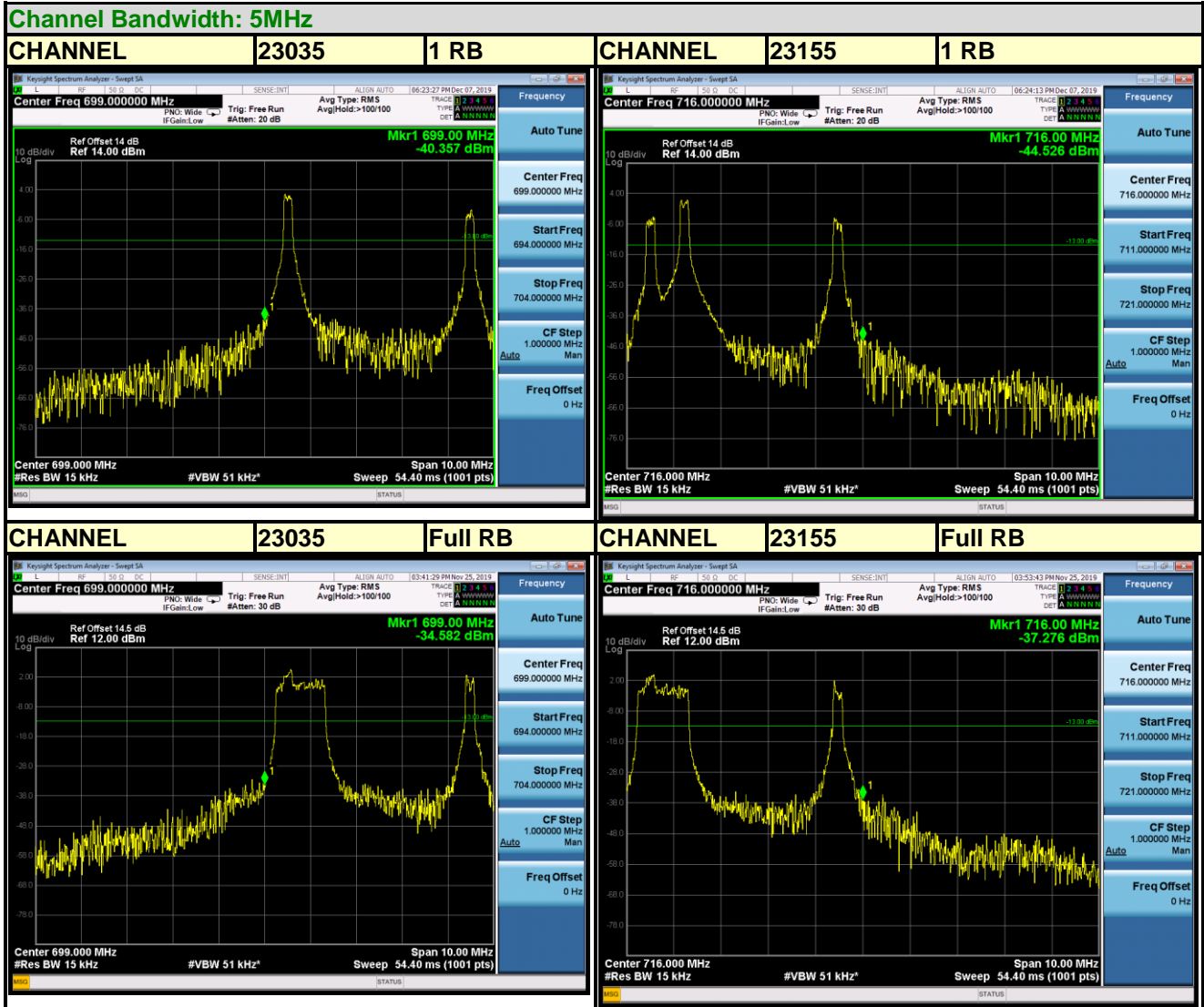



BUREAU VERITAS

Test Report No.: ICP20120029-4

Channel Bandwidth: 10MHz

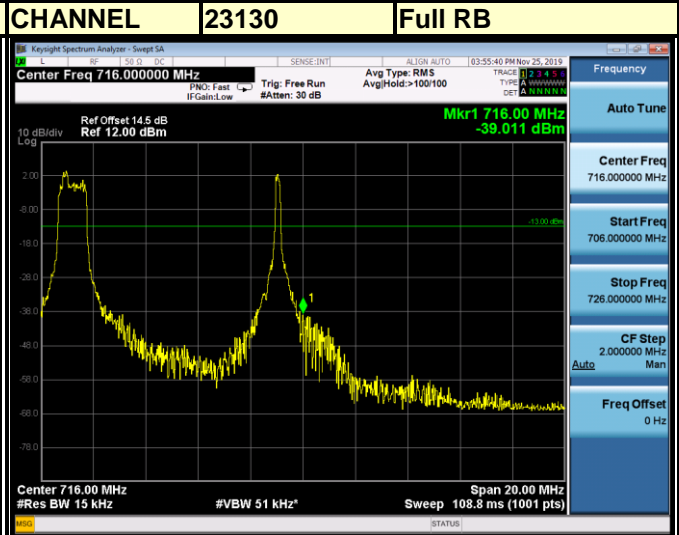
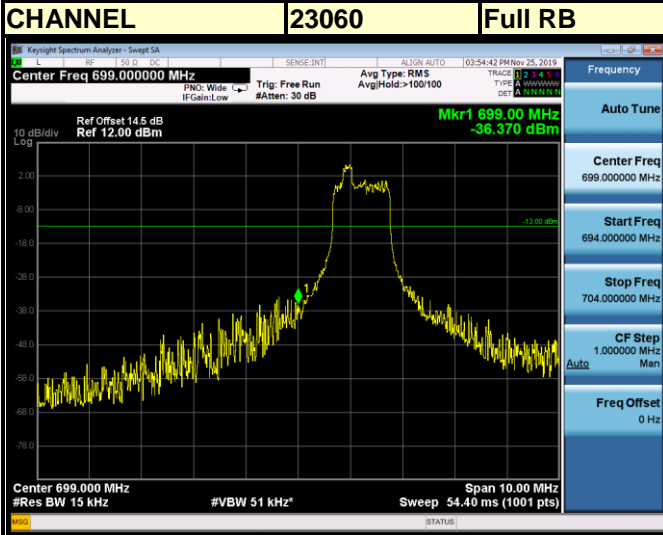
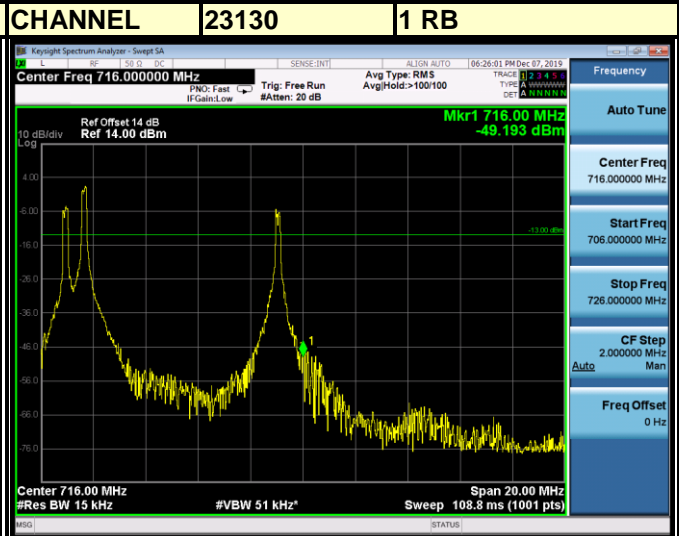
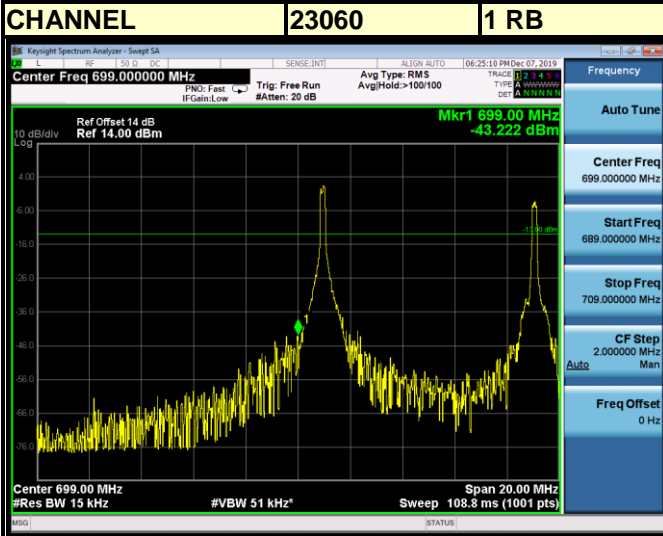



BUREAU VERITAS

Test Report No.: ICP20120029-4

LTE BAND 13

Channel Bandwidth: 5MHz

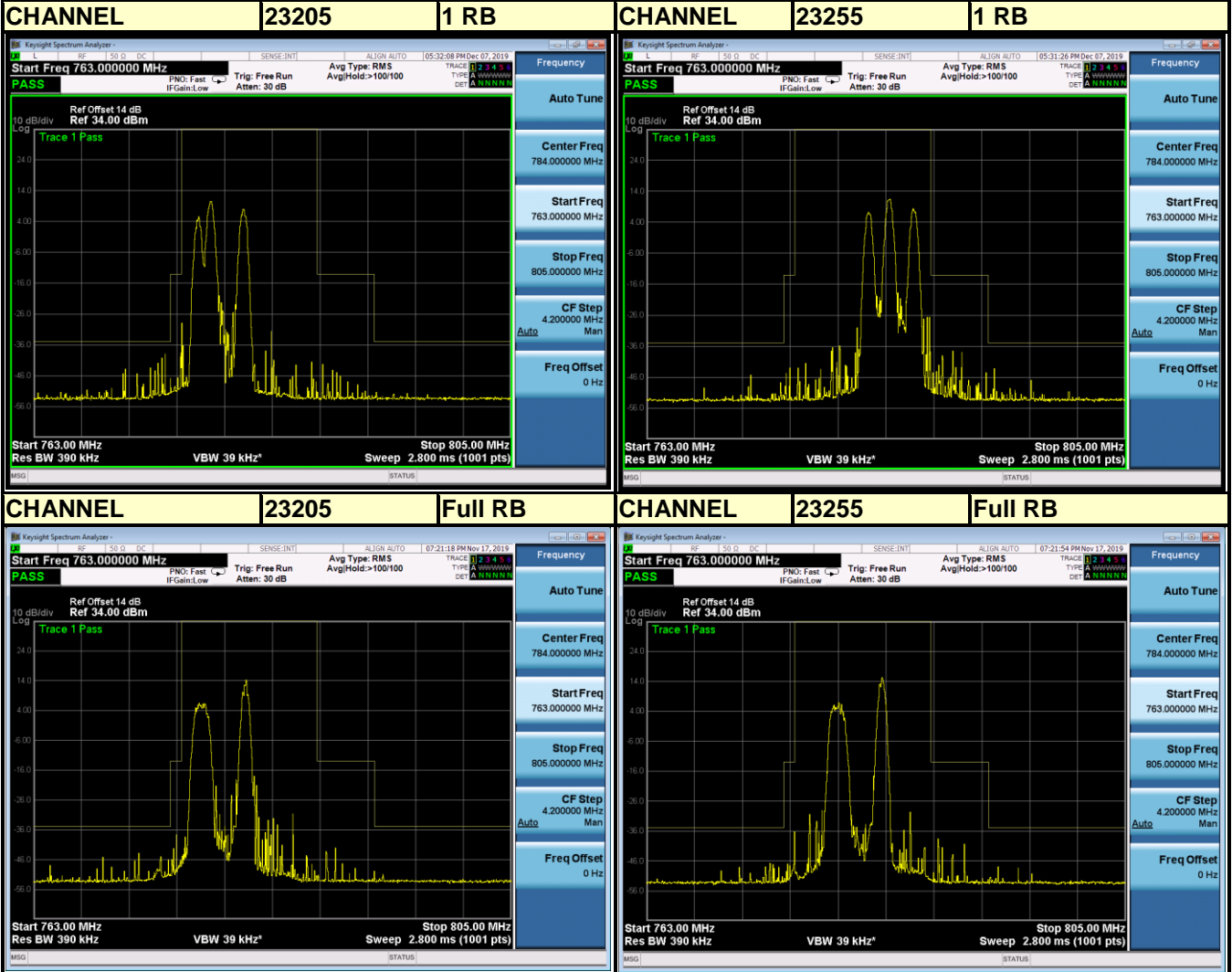



LTE BAND 13

Channel Bandwidth: 10MHz

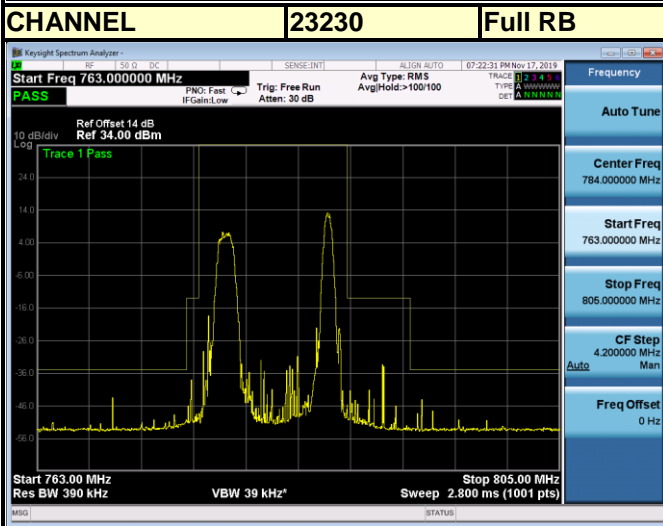
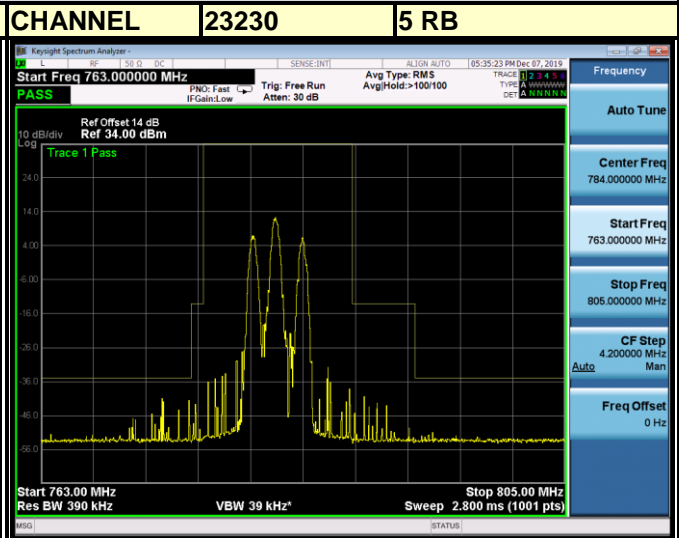
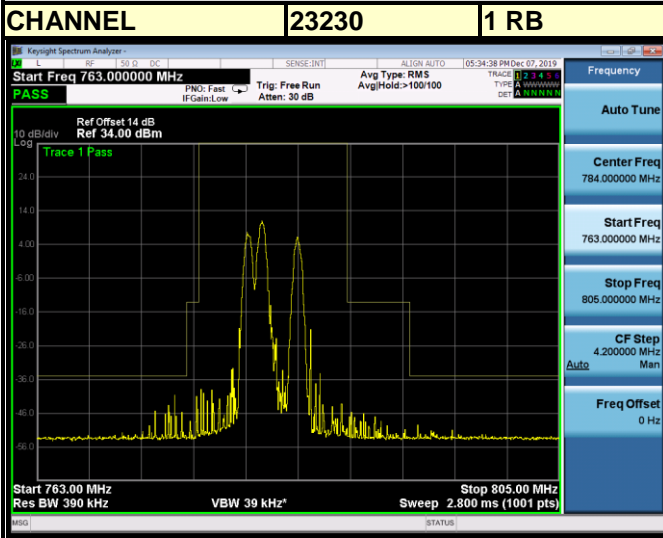



3.6 CONDUCTED SPURIOUS EMISSIONS

3.6.1 LIMITS OF CONDUCTED SPURIOUS EMISSIONS MEASUREMENT

The power of any emission outside a licensee's frequency block shall be attenuated below the transmitter power (P) by at least $43 + 10 \log_{10}(P)$ dB. The limit of emission equal to -13dBm

Additional unwanted emissions limits

In addition to the limit outlined in [section 4.7.1](#) above, equipment operating in the frequency bands 746-756 MHz and 777-787 MHz shall also comply with the following restrictions:

- a. the power of any unwanted emissions in any 6.25 kHz bandwidth for all frequencies between 763-775 MHz and 793-806 MHz shall be attenuated below the transmitter power, P (dBW), by at least:
 - i. $76 + 10 \log_{10} p$ (watts), dB, for base and fixed equipment and
 - ii. $65 + 10 \log_{10} p$ (watts), dB, for mobile and portable equipment
- b. the e.i.r.p. in the band 1559-1610 MHz shall not exceed -70 dBW/MHz for wideband signal and -80 dBW for discrete emission with bandwidth less than 700 Hz.

3.6.2 TEST PROCEDURE

- a. The EUT makes a phone call to the communication simulator. All measurements were done at middle operational frequency range.
- b. Measuring frequency range is from 30 MHz to 8GHz for LTE Band 12&13. 10dB attenuation pad is connected with spectrum. RBW=1MHz and VBW=3MHz are used for conducted emission measurement.



3.6.3 TEST SETUP

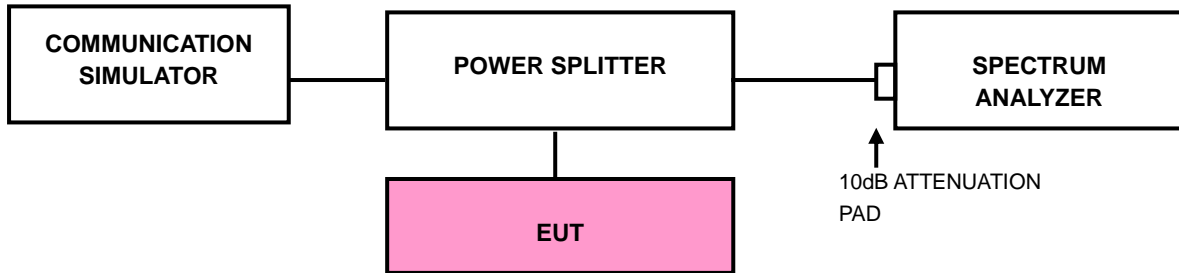

3.6.4 TEST RESULTS

LTE BAND 12

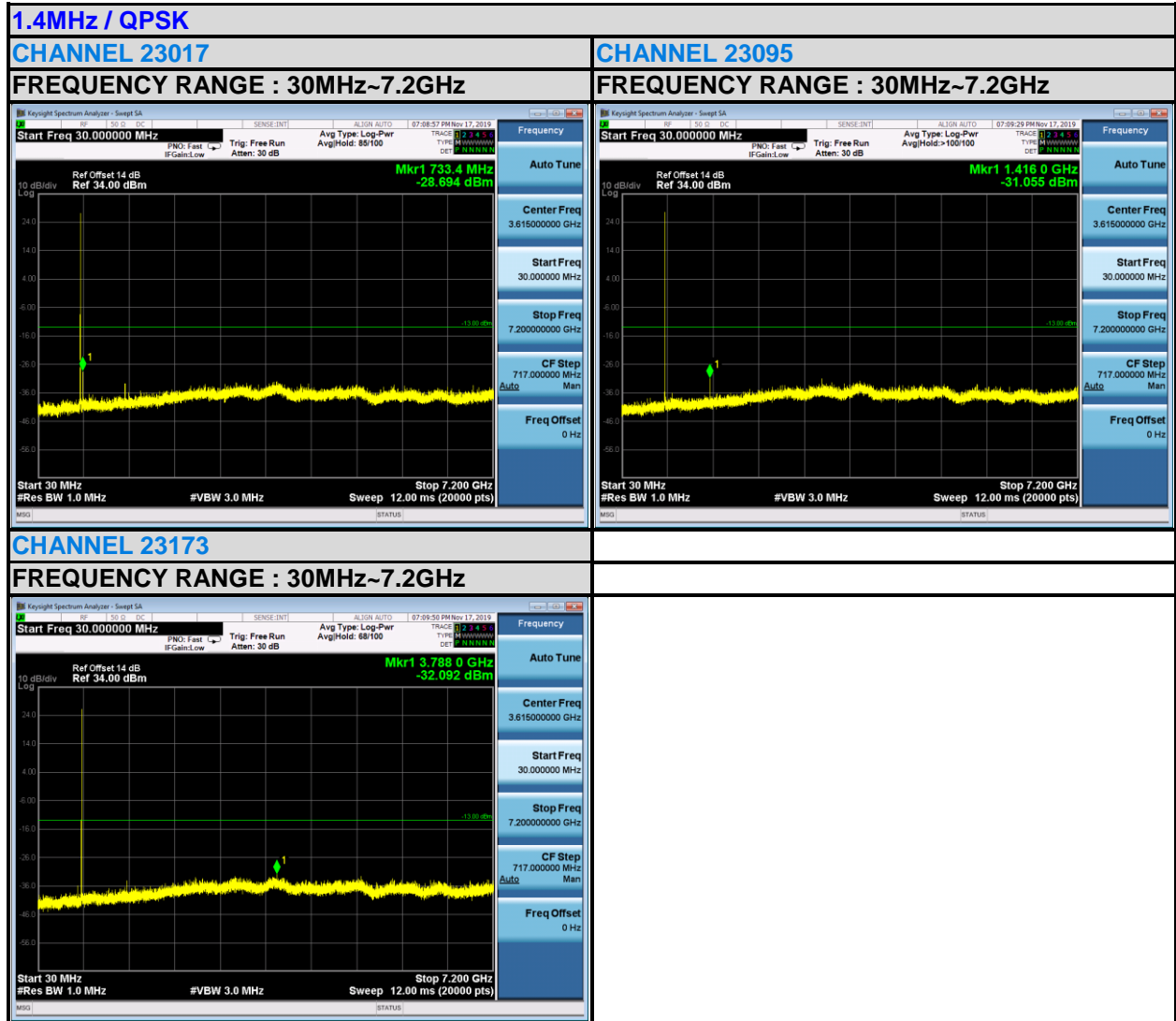



BUREAU VERITAS

Test Report No.: ICP20120029-4

3MHz / QPSK

CHANNEL 23025

FREQUENCY RANGE : 30MHz~7.2GHz

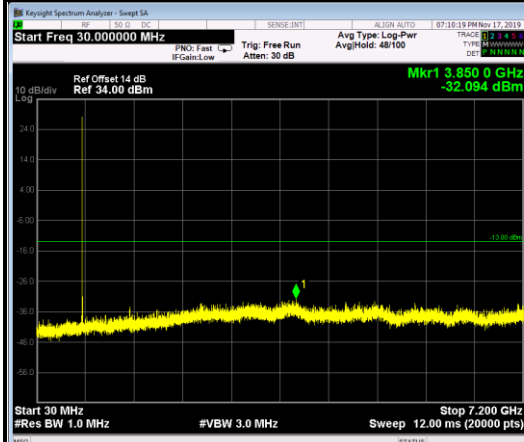

CHANNEL 23095

FREQUENCY RANGE : 30MHz~7.2GHz

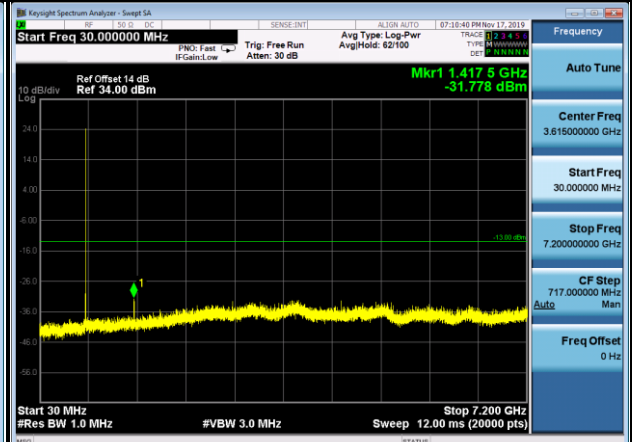

CHANNEL 23165

FREQUENCY RANGE : 30MHz~7.2GHz

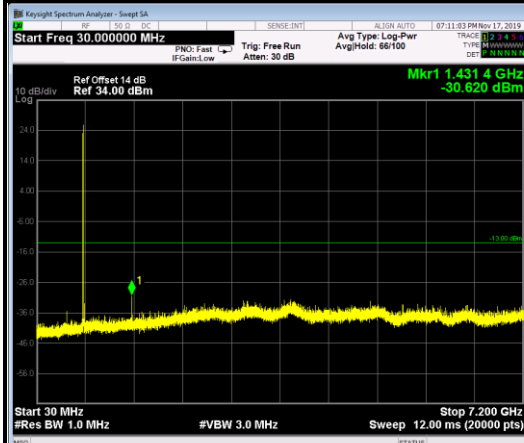

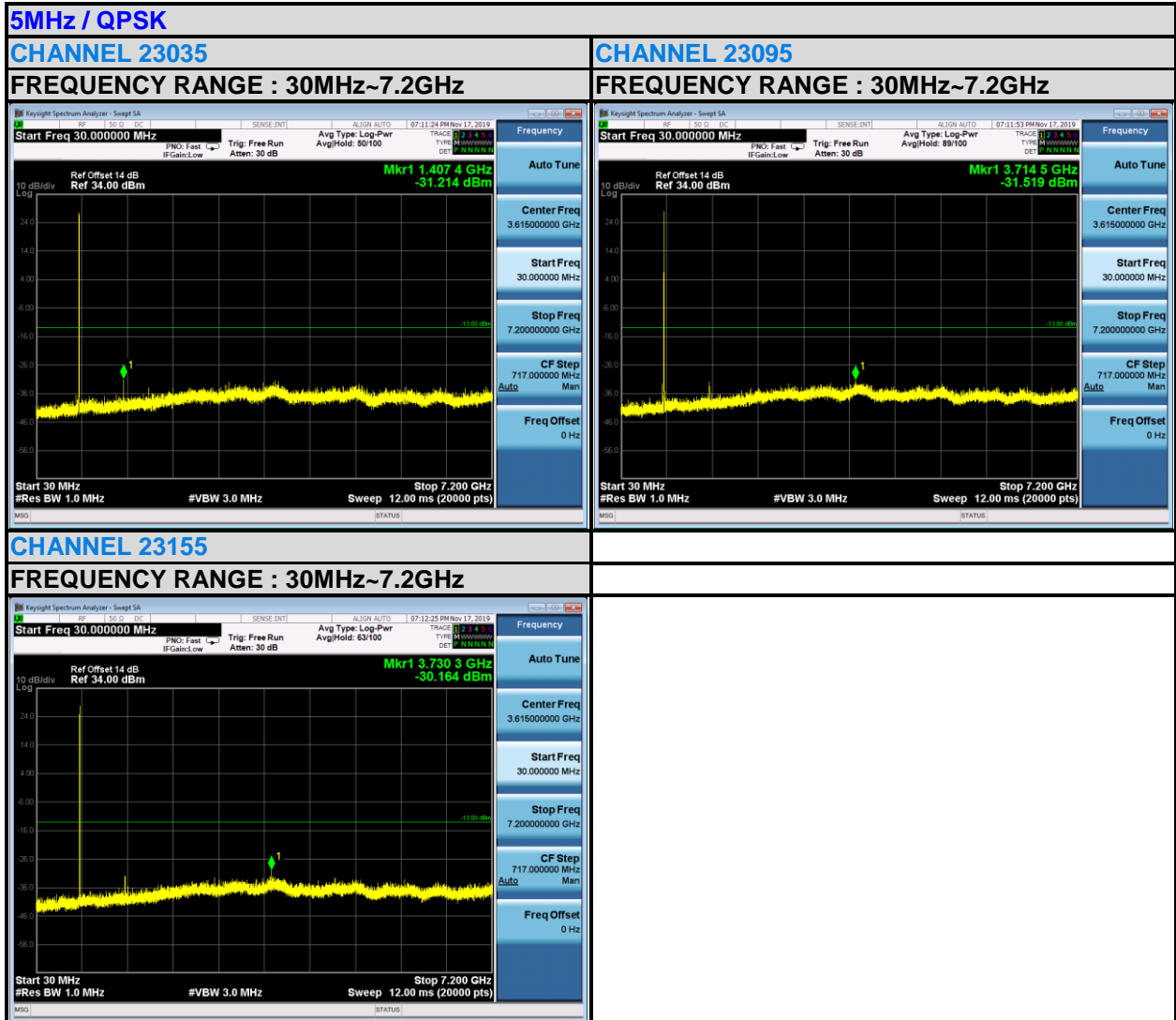



BUREAU VERITAS

Test Report No.: ICP20120029-4

10MHz / QPSK

CHANNEL 23060

FREQUENCY RANGE : 30MHz~7.2GHz

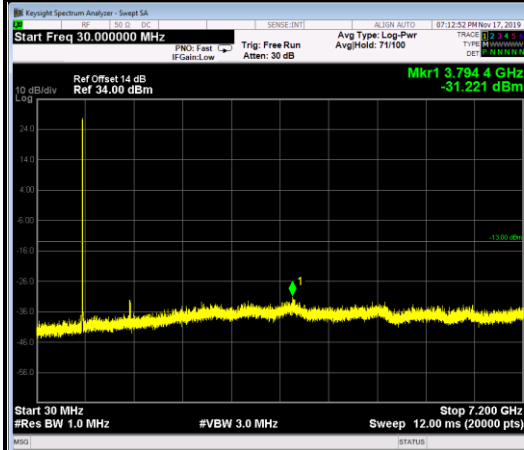

CHANNEL 23095

FREQUENCY RANGE : 30MHz~7.2GHz

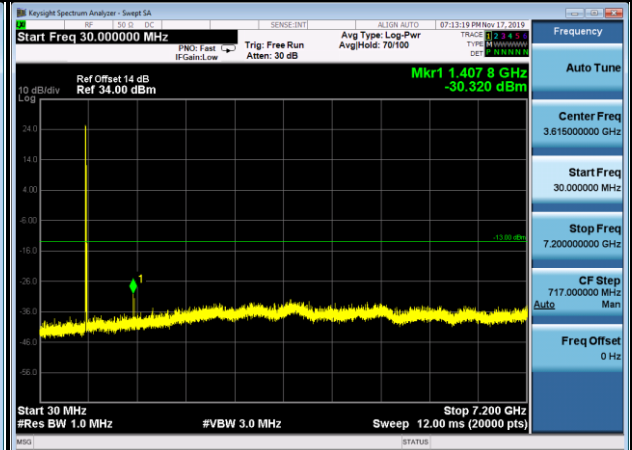

CHANNEL 23130

FREQUENCY RANGE : 30MHz~7.2GHz

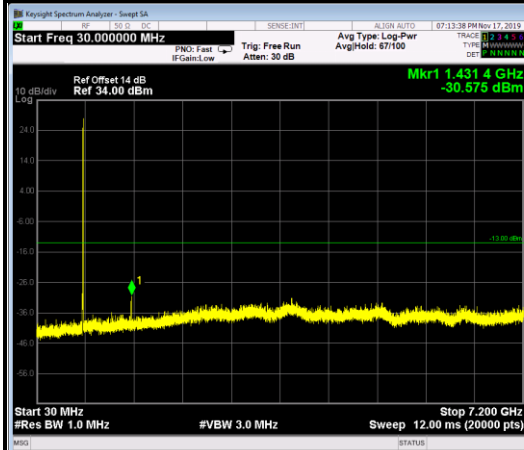



LTE Band 13

5MHz / QPSK

CHANNEL 23205

FREQUENCY RANGE : 30MHz~8GHz

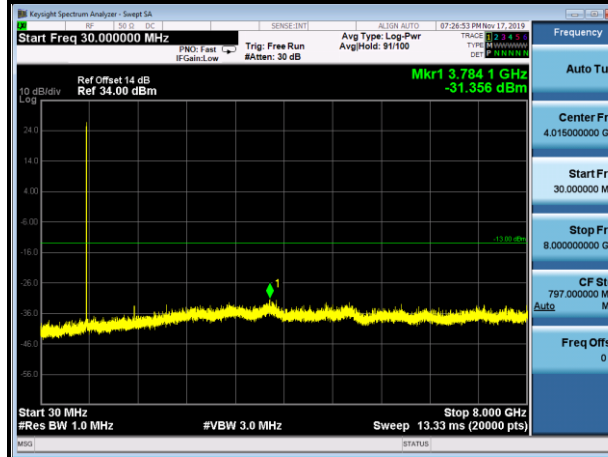

CHANNEL 23230

FREQUENCY RANGE : 30MHz~8 GHz

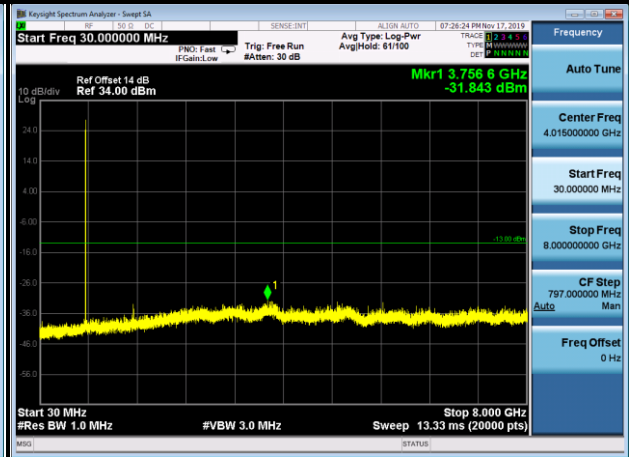

CHANNEL 23255

FREQUENCY RANGE : 30MHz~8GHz

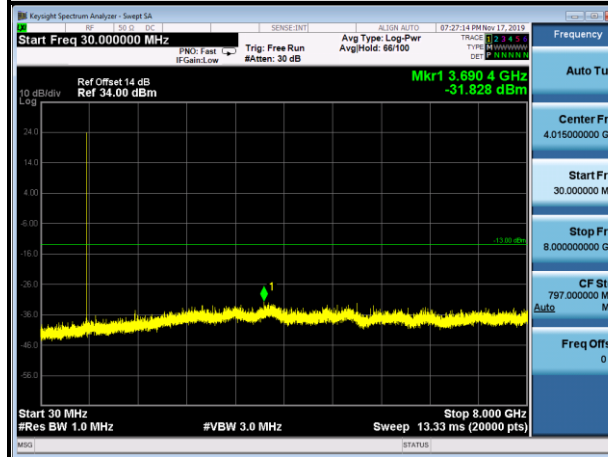



**BUREAU
VERITAS**

Test Report No.: ICP20120029-4

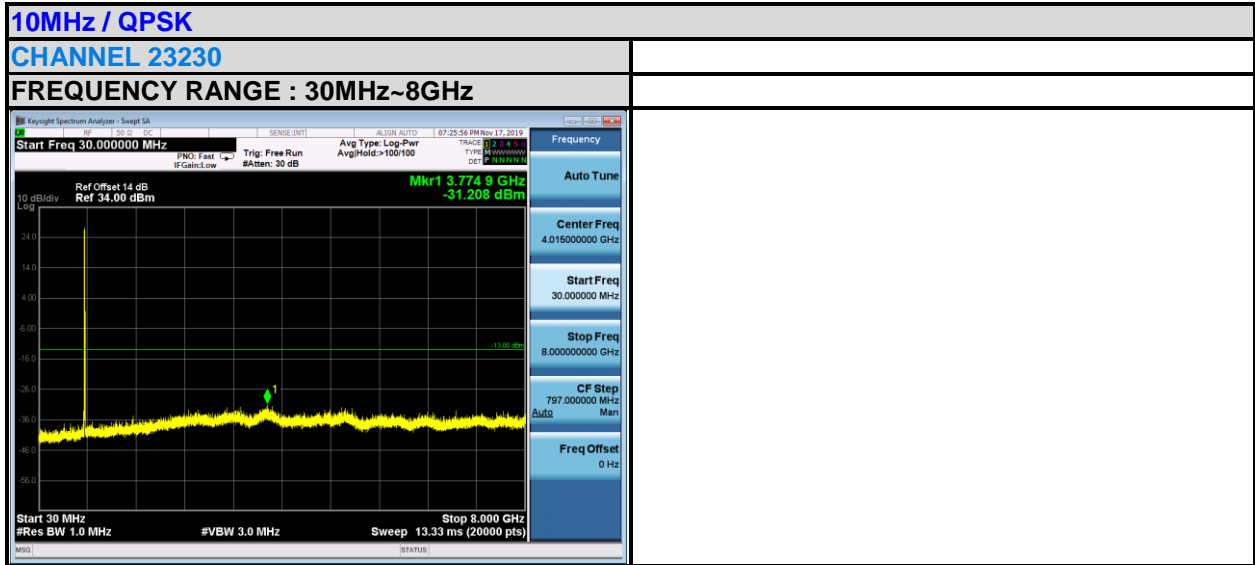



3.7 RADIATED EMISSION MEASUREMENT

3.7.1 LIMITS OF RADIATED EMISSION MEASUREMENT

The power of any emission outside a licensee's frequency block shall be attenuated below the transmitter power (P) by at least $43 + 10 \log_{10}(P)$ dB. The limit of emission equal to -13dBm

3.7.2 TEST PROCEDURES

- a. Substitution method is used for E.I.R.P measurement. In the semi-anechoic chamber, EUT placed on the 0.8m/1.5m height of Turn Table, rotated the table around 360 degrees to search the maximum radiation power and receiver antenna shall be rotated vertical and horizontal polarization and moved height from 1m to 4m to find the maximum polar radiated power. The "Read Value" is the spectrum reading the maximum power value.
- b. The substitution horn antenna is substituted for EUT at the same position and signals generator export the CW signal to the substitution antenna via a TX cable. Rotated the Turn Table and moved receiving antenna to find the maximum radiation power. Adjust output power level of S.G to get a Value of spectrum reading equal to "Read Value" of step a. Record the power level of S.G
- c. $\text{EIRP} = \text{Output power level of S.G} - \text{TX cable loss} + \text{Antenna gain of substitution horn.}$
- d. E.R.P power can be calculated form E.I.R.P power by subtracting the gain of dipole, $\text{E.R.P power} = \text{E.I.P.R power} - 2.15\text{dBi.}$

NOTE: The resolution bandwidth of spectrum analyzer is 1 MHz and the video bandwidth is 3 MHz.

3.7.3 DEVIATION FROM TEST STANDARD

No deviation

3.7.4 TEST SETUP

< Frequency Range 30MHz~1GHz >

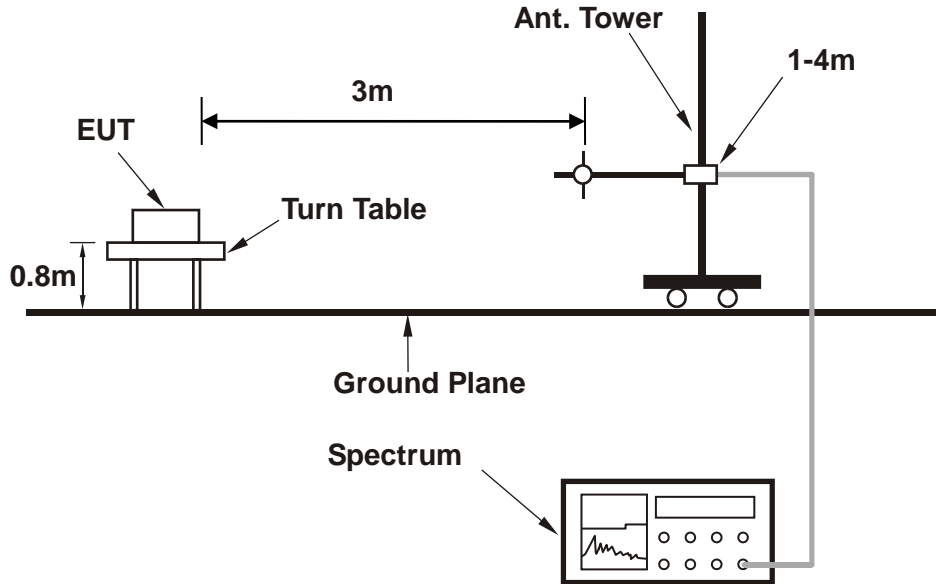

<Frequency Range above 1GHz>

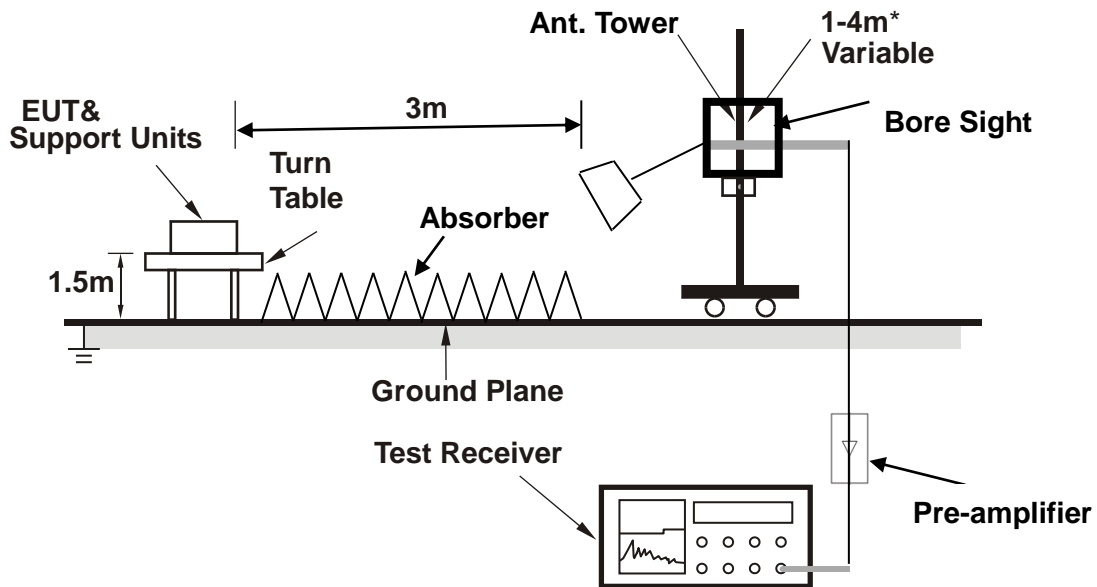

Note: Above 1G is a directional antenna

Depends on the EUT height and the antenna 3dB beamwidth both, refer to section 7.3 of CISPR 16-2-3.

For the actual test configuration, please refer to the attached file (Test Setup Photo).



3.7.5 TEST RESULTS

BELOW 1GHz WORST-CASE DATA

30 MHz – 1GHz data:

LTE BAND 13

CHANNEL BANDWIDTH: 5MHz / QPSK

MODE	TX channel 20175	FREQUENCY RANGE	Below 1000MHz
ENVIRONMENTAL CONDITIONS	23deg. C, 70%RH	INPUT POWER	DC 3.7V by battery
TESTED BY	Star Le		
ANTENNA POLARITY & TEST DISTANCE: HORIZONTAL AT 3 M			

	Freq	Level	Read Level	Limit Line	Over Limit	Factor	Remark	Pol/Phase
	MHz	dBm/m	dBm	dBm/m	dB	dB/m		
1	36.210	-26.86	-39.23	-13.00	-13.86	12.37	Peak	Horizontal
2	49.336	-31.43	-35.15	-13.00	-18.43	3.72	Peak	Horizontal
3	87.245	-40.84	-32.18	-13.00	-27.84	-8.66	Peak	Horizontal
4	110.214	-49.53	-36.24	-13.00	-36.53	-13.29	Peak	Horizontal
5	268.210	-63.00	-47.62	-13.00	-50.00	-15.38	Peak	Horizontal
6	292.260	-62.51	-48.32	-13.00	-49.51	-14.19	Peak	Horizontal

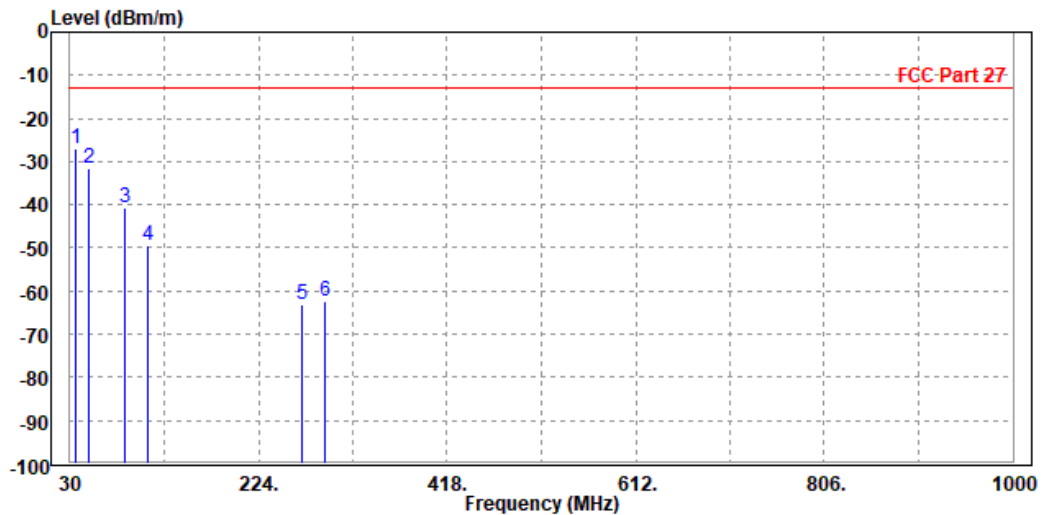



MODE	TX channel 20175	FREQUENCY RANGE	Below 1000MHz
ENVIRONMENTAL CONDITIONS	23deg. C, 70%RH	INPUT POWER	DC 3.7V by battery
TESTED BY	Star Le		
ANTENNA POLARITY & TEST DISTANCE: VERTICAL AT 3 M			

	Freq	Level	Read Level	Limit Line	Over Limit	Factor	Remark	Pol/Phase
	MHz	dBm/m	dBm	dBm/m	dB	dB/m		
1	33.147	-39.12	-40.26	-13.00	-26.12	1.14	Peak	Vertical
2 PP	46.290	-38.72	-35.14	-13.00	-25.72	-3.58	Peak	Vertical
3	84.260	-40.48	-30.11	-13.00	-27.48	-10.37	Peak	Vertical
4	108.240	-45.61	-33.85	-13.00	-32.61	-11.76	Peak	Vertical
5	269.214	-63.77	-52.34	-13.00	-50.77	-11.43	Peak	Vertical
6	295.330	-63.65	-52.33	-13.00	-50.65	-11.32	Peak	Vertical

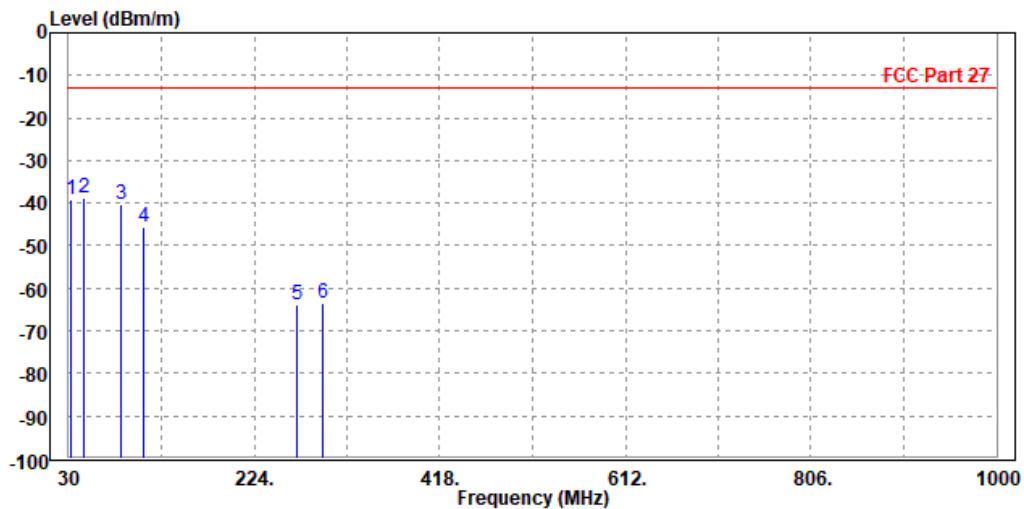



ABOVE 1GHz

Note: For higher frequency, the emission is too low to be detected.

LTE BAND 12

CHANNEL BANDWIDTH: 1.4MHz / QPSK

MODE	TX channel 23095	FREQUENCY RANGE	Above 1000MHz
ENVIRONMENTAL CONDITIONS	23deg. C, 70%RH	INPUT POWER	DC 3.7V by battery
TESTED BY	Star Le		
ANTENNA POLARITY & TEST DISTANCE: HORIZONTAL AT 3 M			

	Freq	Level	Read Level	Limit Line	Over Limit	Factor	Remark	Pol/Phase
	MHz	dBm/m	dBm	dBm/m	dB	dB/m		
1	PP 1416.000	-46.49	-47.57	-13.00	-33.49	1.08	Peak	Horizontal
2	2122.500	-49.48	-57.15	-13.00	-36.48	7.67	Peak	Horizontal

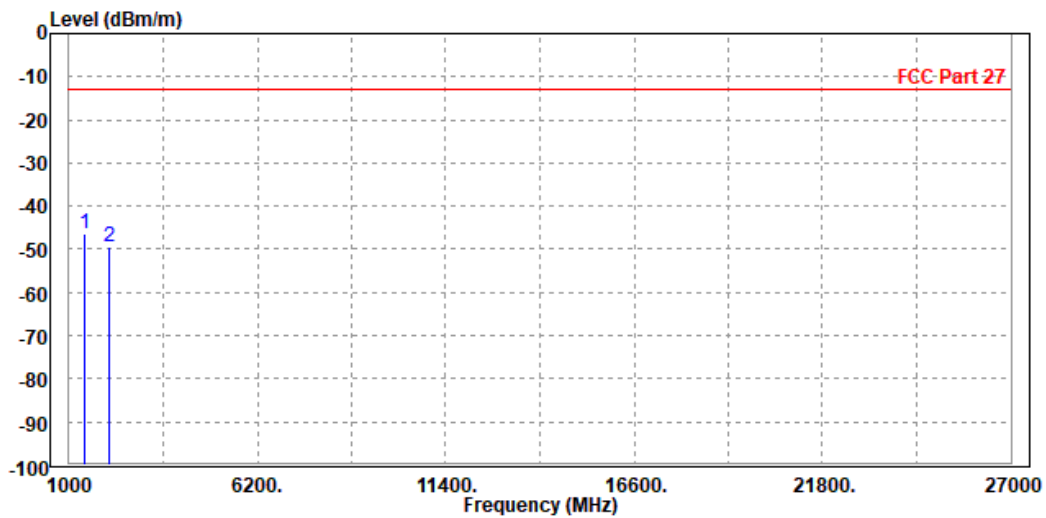



MODE	TX channel 23095	FREQUENCY RANGE	Above 1000MHz
ENVIRONMENTAL CONDITIONS	23deg. C, 70%RH	INPUT POWER	DC 3.7V by battery
TESTED BY	Star Le		
ANTENNA POLARITY & TEST DISTANCE: VERTICAL AT 3 M			

	Freq	Level	Read Level	Limit Line	Over Limit	Factor	Remark	Pol/Phase
	MHz	dBm/m	dBm	dBm/m	dB	dB/m		
1 PP	1416.000	-50.29	-51.98	-13.00	-37.29	1.69	Peak	Vertical
2	2122.500	-50.37	-57.06	-13.00	-37.37	6.69	Peak	Vertical

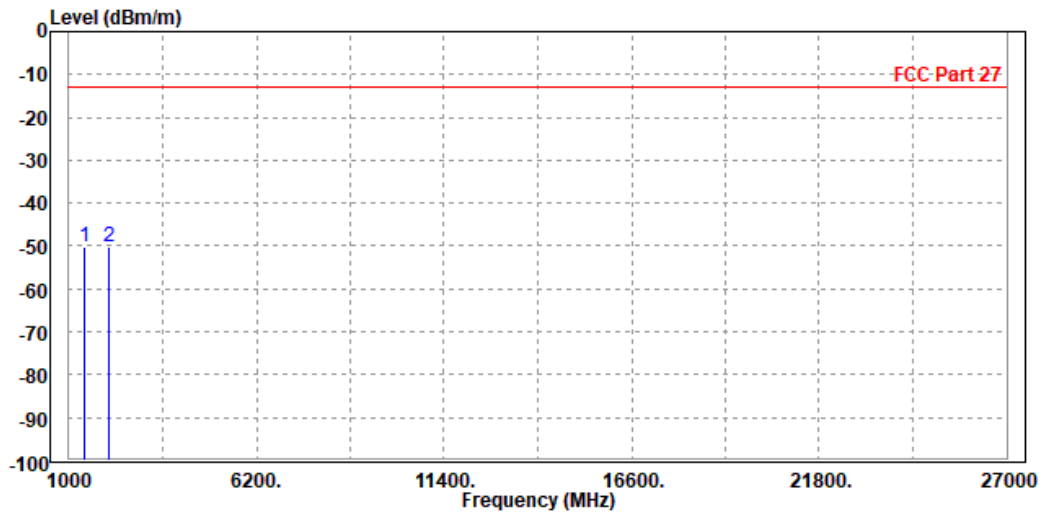



CHANNEL BANDWIDTH: 3MHz / QPSK

MODE	TX channel 23095	FREQUENCY RANGE	Above 1000MHz
ENVIRONMENTAL CONDITIONS	23deg. C, 70%RH	INPUT POWER	DC 3.7V by battery
TESTED BY	Star Le		
ANTENNA POLARITY & TEST DISTANCE: HORIZONTAL AT 3 M			

	Freq	Level	Read Level	Limit Line	Over Limit	Factor	Remark	Pol/Phase
	MHz	dBm/m	dBm	dBm/m	dB	dB/m		
1 PP	1416.000	-45.94	-47.02	-13.00	-32.94	1.08	Peak	Horizontal
2	2122.500	-48.39	-56.06	-13.00	-35.39	7.67	Peak	Horizontal

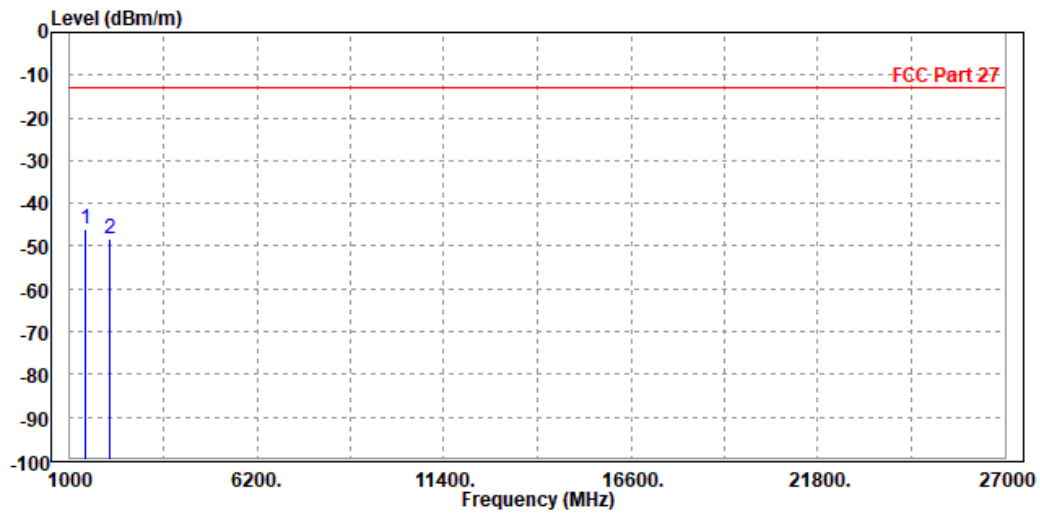



MODE	TX channel 23095	FREQUENCY RANGE	Above 1000MHz
ENVIRONMENTAL CONDITIONS	23deg. C, 70%RH	INPUT POWER	DC 3.7V by battery
TESTED BY	Star Le		
ANTENNA POLARITY & TEST DISTANCE: VERTICAL AT 3 M			

	Freq	Level	Read Level	Limit Line	Over Limit	Factor	Remark	Pol/Phase
	MHz	dBm/m	dBm	dBm/m	dB	dB/m		
1	1416.000	-51.61	-53.30	-13.00	-38.61	1.69	Peak	Vertical
2	PP 2122.500	-50.45	-57.14	-13.00	-37.45	6.69	Peak	Vertical

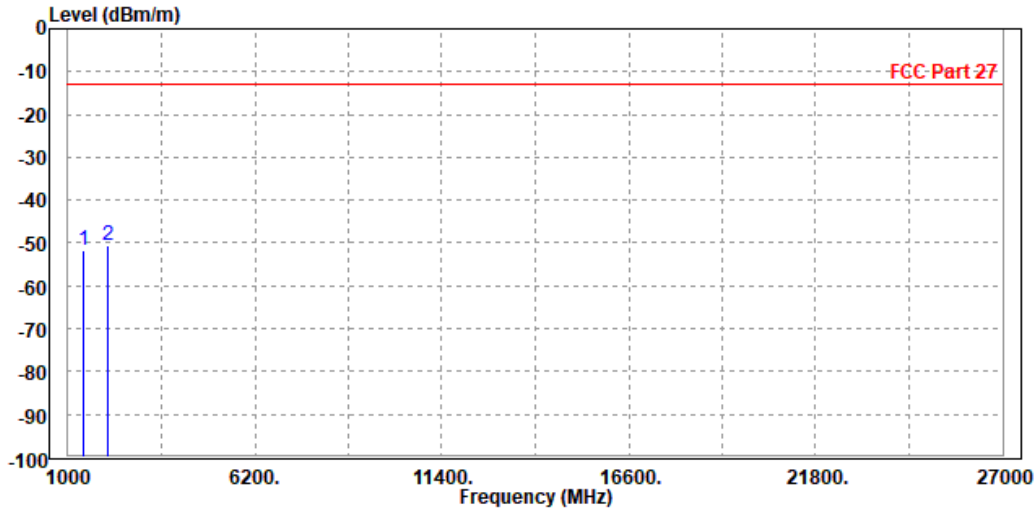



CHANNEL BANDWIDTH: 5MHz / QPSK

MODE	TX channel 23095	FREQUENCY RANGE	Above 1000MHz
ENVIRONMENTAL CONDITIONS	23deg. C, 70%RH	INPUT POWER	DC 3.7V by battery
TESTED BY	Star Le		
ANTENNA POLARITY & TEST DISTANCE: HORIZONTAL AT 3 M			

	Freq	Level	Read Level	Limit Line	Over Limit	Factor	Remark	Pol/Phase
	MHz	dBm/m	dBm	dBm/m	dB	dB/m		
1	PP 1416.000	-47.29	-48.37	-13.00	-34.29	1.08	Peak	Horizontal
2	2122.500	-49.16	-56.83	-13.00	-36.16	7.67	Peak	Horizontal

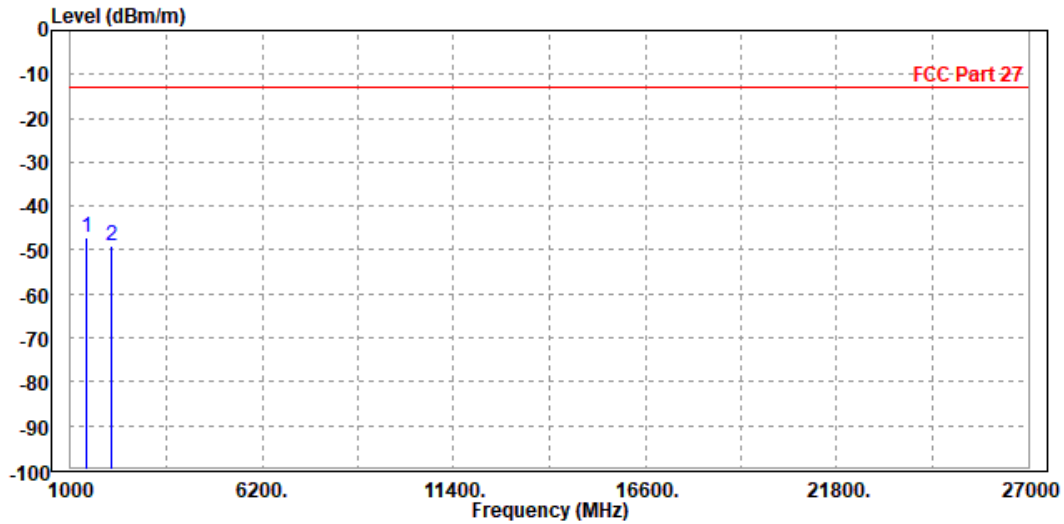



MODE	TX channel 23095	FREQUENCY RANGE	Above 1000MHz
ENVIRONMENTAL CONDITIONS	23deg. C, 70%RH	INPUT POWER	DC 3.7V by battery
TESTED BY	Star Le		
ANTENNA POLARITY & TEST DISTANCE: VERTICAL AT 3 M			

	Freq	Level	Read Level	Limit Line	Over Limit	Factor	Remark	Pol/Phase
	MHz	dBm/m	dBm	dBm/m	dB	dB/m		
1	1416.000	-51.35	-53.04	-13.00	-38.35	1.69	Peak	Vertical
2 PP	2122.500	-49.86	-56.55	-13.00	-36.86	6.69	Peak	Vertical

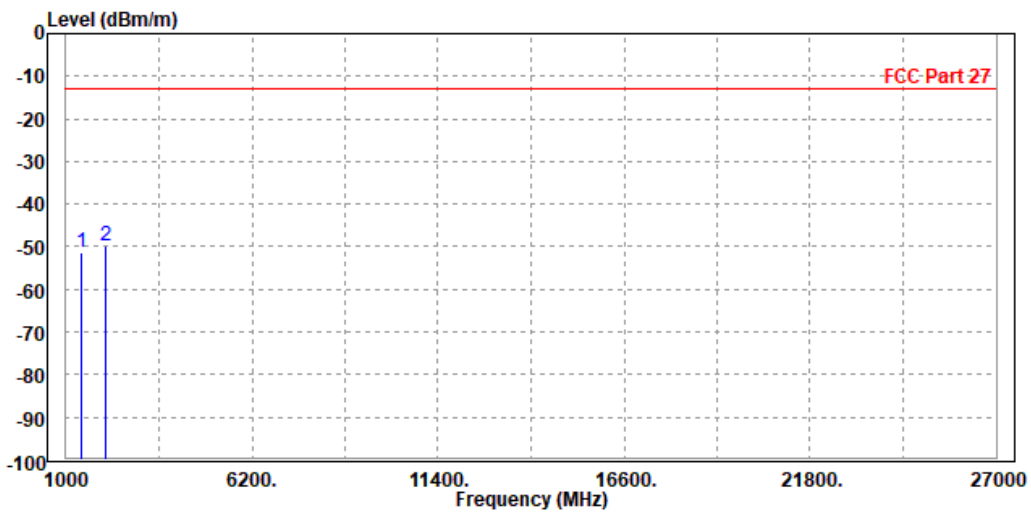



CHANNEL BANDWIDTH: 10MHz / QPSK

CH 23060

MODE	TX channel 23060	FREQUENCY RANGE	Above 1000MHz
ENVIRONMENTAL CONDITIONS	23deg. C, 70%RH	INPUT POWER	DC 3.7V by battery
TESTED BY	Star Le		
ANTENNA POLARITY & TEST DISTANCE: HORIZONTAL AT 3 M			

	Freq	Level	Read Level	Limit Line	Over Limit	Factor	Remark	Pol/Phase
	MHz	dBm/m	dBm	dBm/m	dB	dB/m		
1	PP 1404.000	-46.03	-47.06	-13.00	-33.03	1.03	Peak	Horizontal
2	2104.500	-48.48	-56.13	-13.00	-35.48	7.65	Peak	Horizontal

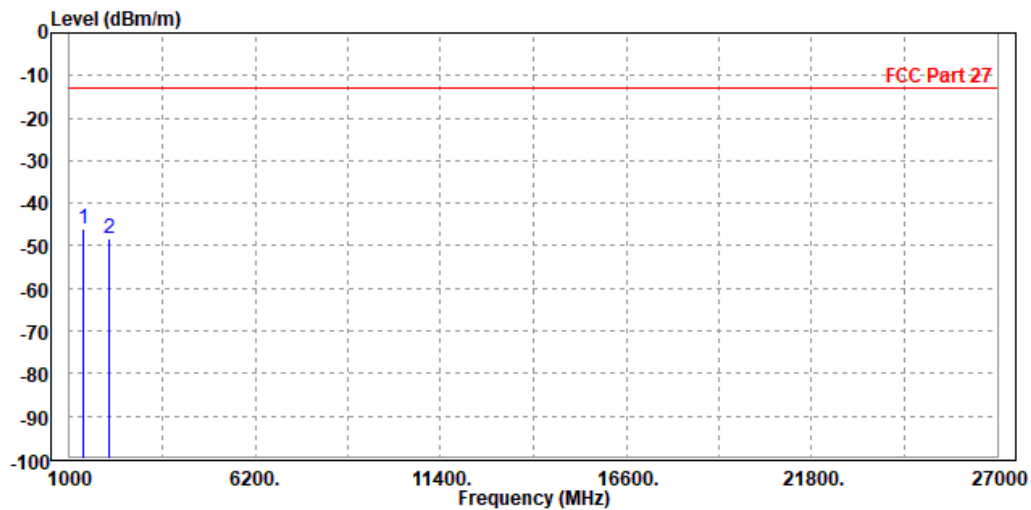



MODE	TX channel 23060	FREQUENCY RANGE	Above 1000MHz
ENVIRONMENTAL CONDITIONS	23deg. C, 70%RH	INPUT POWER	DC 3.7V by battery
TESTED BY	Star Le		
ANTENNA POLARITY & TEST DISTANCE: VERTICAL AT 3 M			

	Freq	Level	Read Level	Limit Line	Over Limit	Factor	Remark	Pol/Phase
	MHz	dBm/m	dBm	dBm/m	dB	dB/m		
1	1404.000	-52.38	-54.02	-13.00	-39.38	1.64	Peak	Vertical
2 PP	2104.500	-49.63	-56.30	-13.00	-36.63	6.67	Peak	Vertical

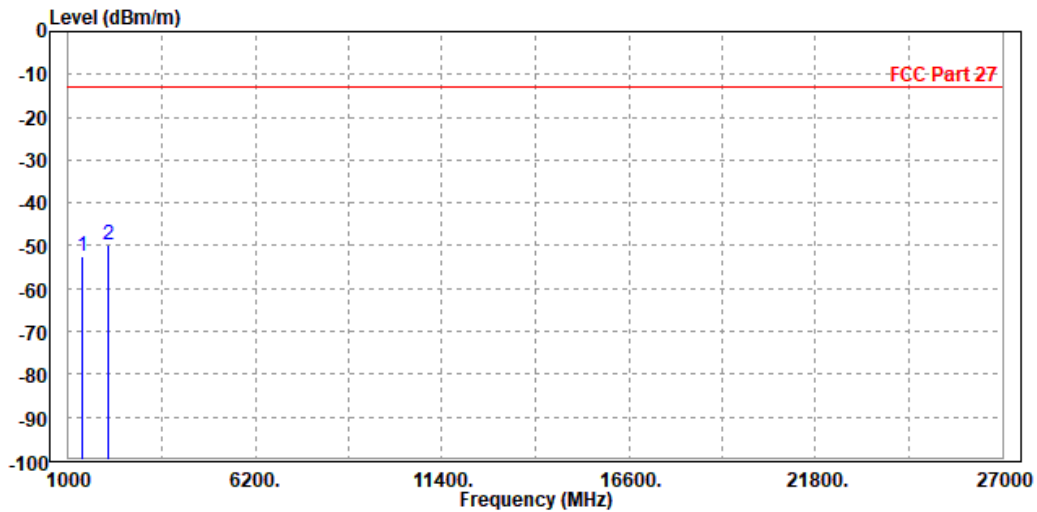



CH 23095

MODE	TX channel 23095	FREQUENCY RANGE	Above 1000MHz
ENVIRONMENTAL CONDITIONS	23deg. C, 70%RH	INPUT POWER	DC 3.7V by battery
TESTED BY	Star Le		
ANTENNA POLARITY & TEST DISTANCE: HORIZONTAL AT 3 M			

	Freq	Level	Read Level	Limit Line	Over Limit	Factor	Remark	Pol/Phase
	MHz	dBm/m	dBm	dBm/m	dB	dB/m		
1	1416.000	-58.45	-59.53	-13.00	-45.45	1.08	Peak	Horizontal
2	PP 2122.500	-51.76	-59.43	-13.00	-38.76	7.67	Peak	Horizontal

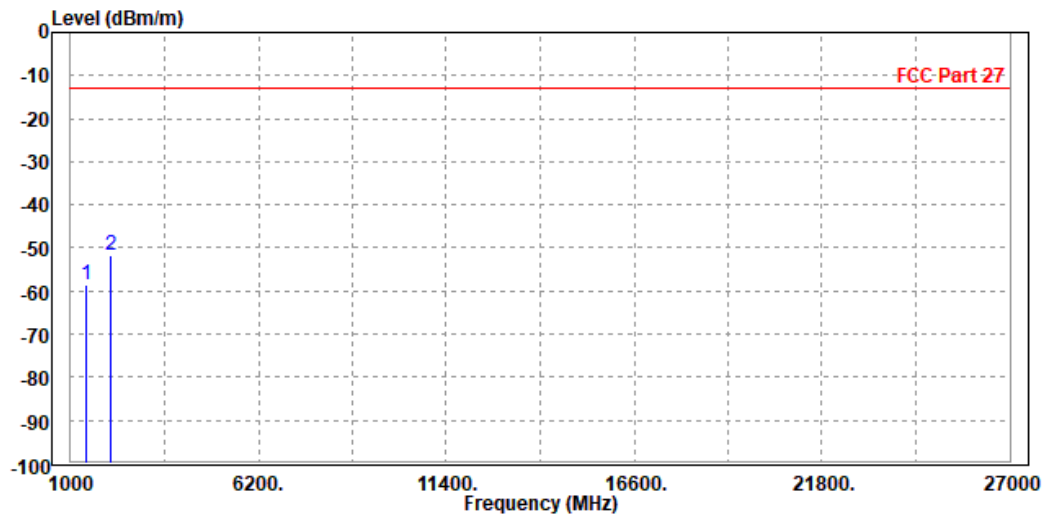



MODE	TX channel 23095	FREQUENCY RANGE	Above 1000MHz
ENVIRONMENTAL CONDITIONS	23deg. C, 70%RH	INPUT POWER	DC 3.7V by battery
TESTED BY	Star Le		
ANTENNA POLARITY & TEST DISTANCE: VERTICAL AT 3 M			

	Freq	Level	Read Level	Limit Line	Over Limit	Factor	Remark	Pol/Phase
	MHz	dBm/m	dBm	dBm/m	dB	dB/m		
1	1416.000	-49.82	-51.51	-13.00	-36.82	1.69	Peak	Vertical
2 PP	2122.500	-45.16	-51.85	-13.00	-32.16	6.69	Peak	Vertical

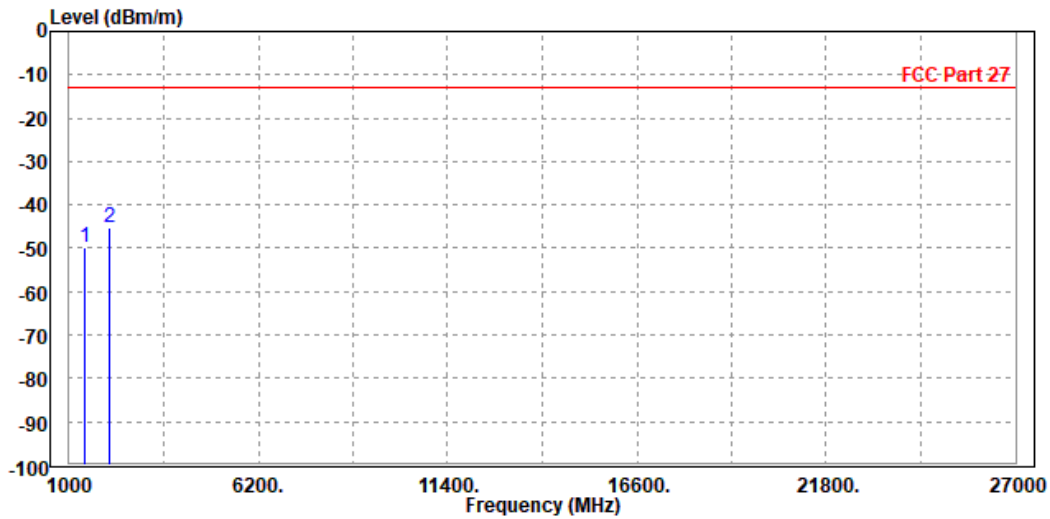



CH 23130

MODE	TX channel 23130	FREQUENCY RANGE	Above 1000MHz
ENVIRONMENTAL CONDITIONS	23deg. C, 70%RH	INPUT POWER	DC 3.7V by battery
TESTED BY	Star Le		
ANTENNA POLARITY & TEST DISTANCE: HORIZONTAL AT 3 M			

	Freq	Level	Read Level	Limit Line	Over Limit	Factor	Remark	Pol/Phase
	MHz	dBm/m	dBm	dBm/m	dB	dB/m		
1 PP	1427.000	-45.00	-46.13	-13.00	-32.00	1.13	Peak	Horizontal
2	2144.000	-49.55	-57.24	-13.00	-36.55	7.69	Peak	Horizontal

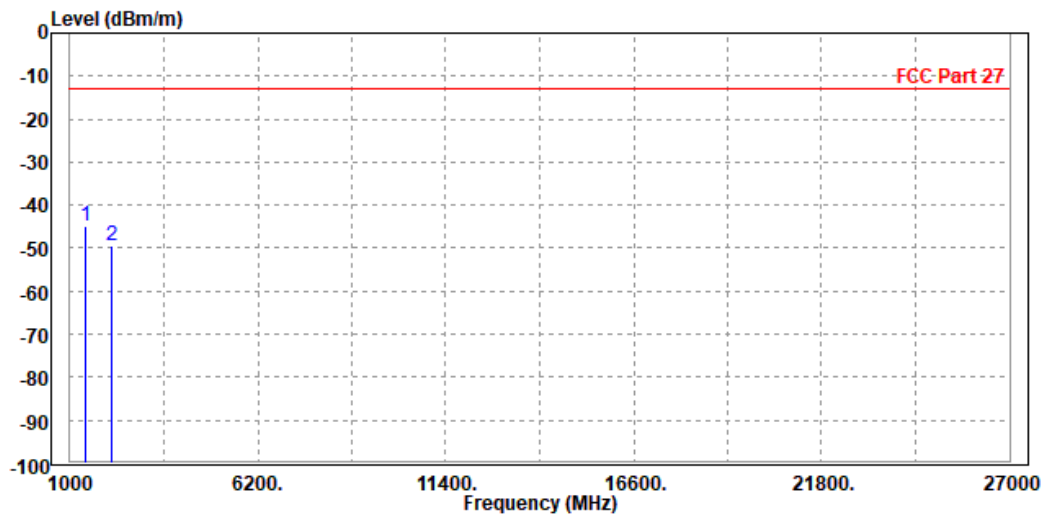



MODE	TX channel 23130	FREQUENCY RANGE	Above 1000MHz
ENVIRONMENTAL CONDITIONS	23deg. C, 70%RH	INPUT POWER	DC 3.7V by battery
TESTED BY	Star Le		
ANTENNA POLARITY & TEST DISTANCE: VERTICAL AT 3 M			

	Freq	Level	Read Level	Limit Line	Over Limit	Factor	Remark	Pol/Phase
	MHz	dBm/m	dBm	dBm/m	dB	dB/m		
1	PP 1427.000	-45.98	-47.11	-13.00	-32.98	1.13	Peak	Vertical
2	2140.500	-46.86	-54.55	-13.00	-33.86	7.69	Peak	Vertical

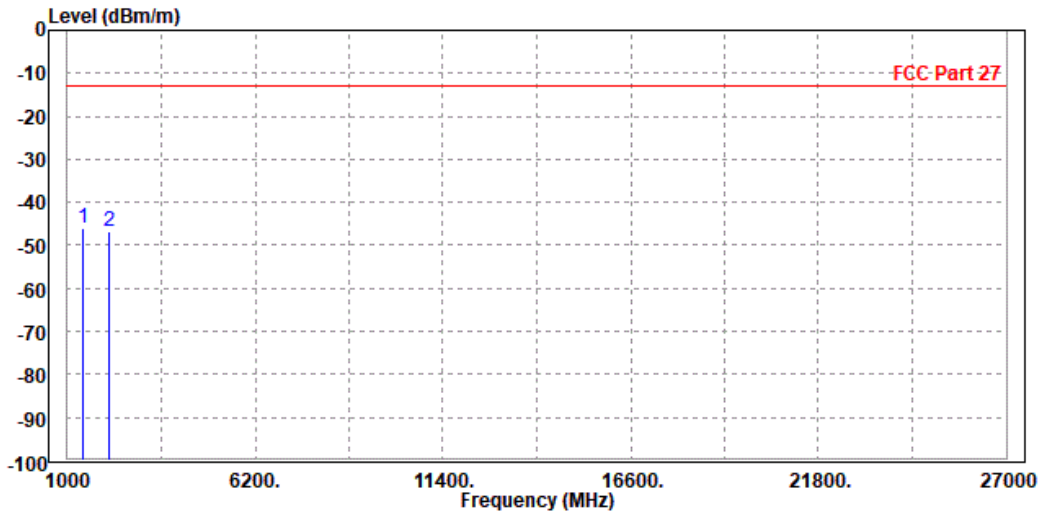



LTE BAND 13

CHANNEL BANDWIDTH: 5MHz / QPSK

CH 23205

MODE	TX channel 23205	FREQUENCY RANGE	Above 1000MHz
ENVIRONMENTAL CONDITIONS	23deg. C, 70%RH	INPUT POWER	DC 3.7V by battery
TESTED BY	Star Le		
ANTENNA POLARITY & TEST DISTANCE: HORIZONTAL AT 3 M			

	Freq	Level	Read Level	Limit Line	Over Limit	Factor	Remark	Pol/Phase
	MHz	dBm/m	dBm	dBm/m	dB	dB/m		
1 PP	1558.000	-30.94	-33.09	-13.00	-17.94	2.15	Peak	Horizontal
2	2338.500	-31.99	-39.88	-13.00	-18.99	7.89	Peak	Horizontal

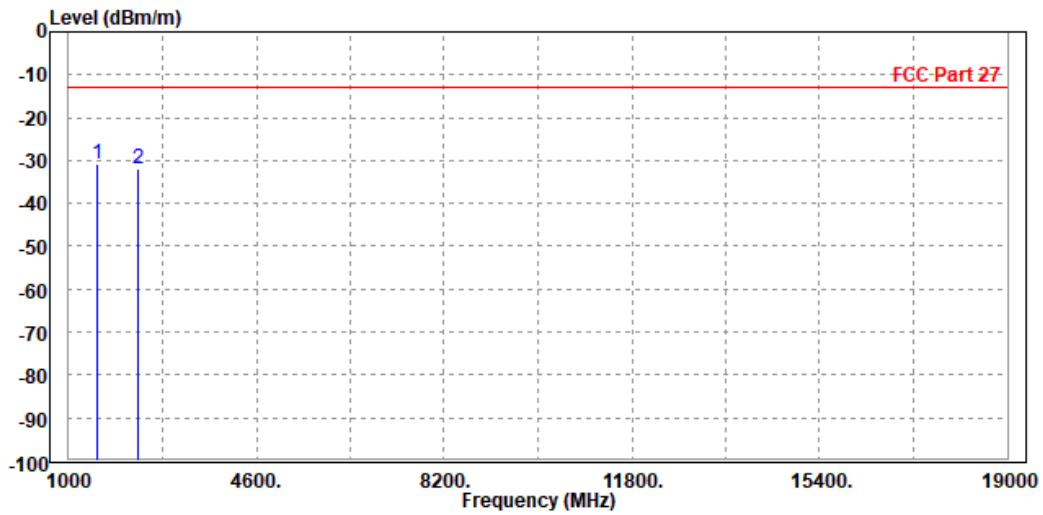



MODE	TX channel 23205	FREQUENCY RANGE	Above 1000MHz
ENVIRONMENTAL CONDITIONS	23deg. C, 70%RH	INPUT POWER	DC 3.7V by battery
TESTED BY	Star Le		
ANTENNA POLARITY & TEST DISTANCE: VERTICAL AT 3 M			

	Freq	Level	Read Level	Limit Line	Over Limit	Factor	Remark	Pol/Phase
	MHz	dBm/m	dBm	dBm/m	dB	dB/m		
1	1558.000	-39.74	-42.31	-13.00	-26.74	2.57	Peak	Vertical
2	PP 2338.500	-38.57	-45.47	-13.00	-25.57	6.90	Peak	Vertical

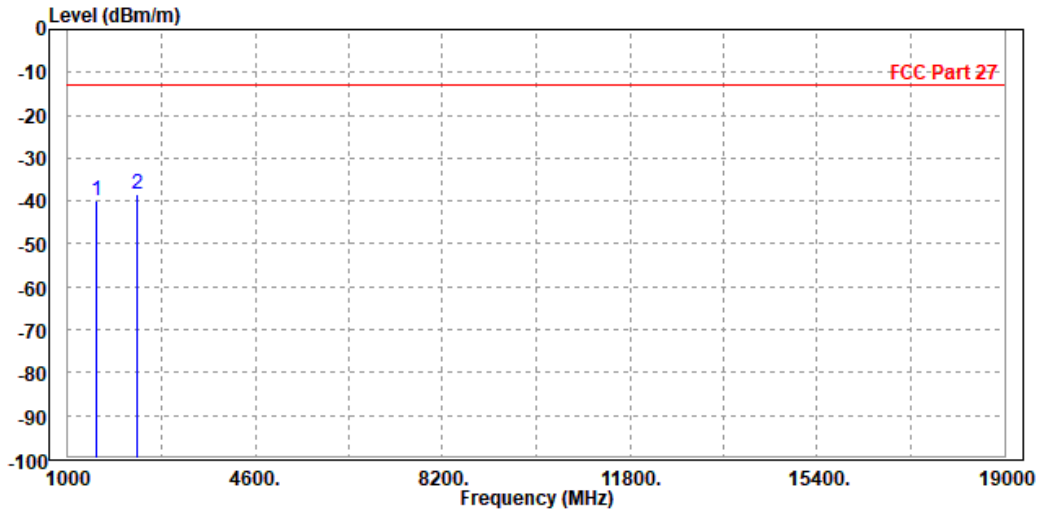



CH 23230

MODE	TX channel 23230	FREQUENCY RANGE	Above 1000MHz
ENVIRONMENTAL CONDITIONS	23deg. C, 70%RH	INPUT POWER	DC 3.7V by battery
TESTED BY	Star Le		
ANTENNA POLARITY & TEST DISTANCE: HORIZONTAL AT 3 M			

	Freq	Level	Read Level	Limit Line	Over Limit	Factor	Remark	Pol/Phase
	MHz	dBm/m	dBm	dBm/m	dB	dB/m		
1	1558.000	-35.26	-37.41	-13.00	-22.26	2.15	Peak	Horizontal
2 PP	2346.000	-31.90	-39.80	-13.00	-18.90	7.90	Peak	Horizontal

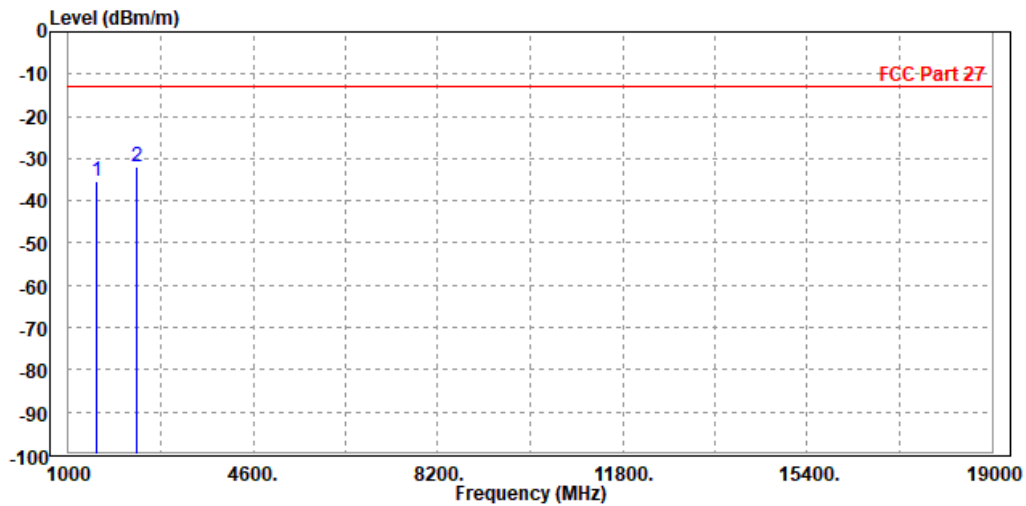



MODE	TX channel 23230	FREQUENCY RANGE	Above 1000MHz
ENVIRONMENTAL CONDITIONS	23deg. C, 70%RH	INPUT POWER	DC 3.7V by battery
TESTED BY	Star Le		
ANTENNA POLARITY & TEST DISTANCE: VERTICAL AT 3 M			

	Freq	Level	Read Level	Limit Line	Over Limit	Factor	Remark	Pol/Phase
	MHz	dBm/m	dBm	dBm/m	dB	dB/m		
1	PP 1558.000	-40.15	-42.72	-13.00	-27.15	2.57	Peak	Vertical
2	2350.000	-44.33	-51.25	-13.00	-31.33	6.92	Peak	Vertical

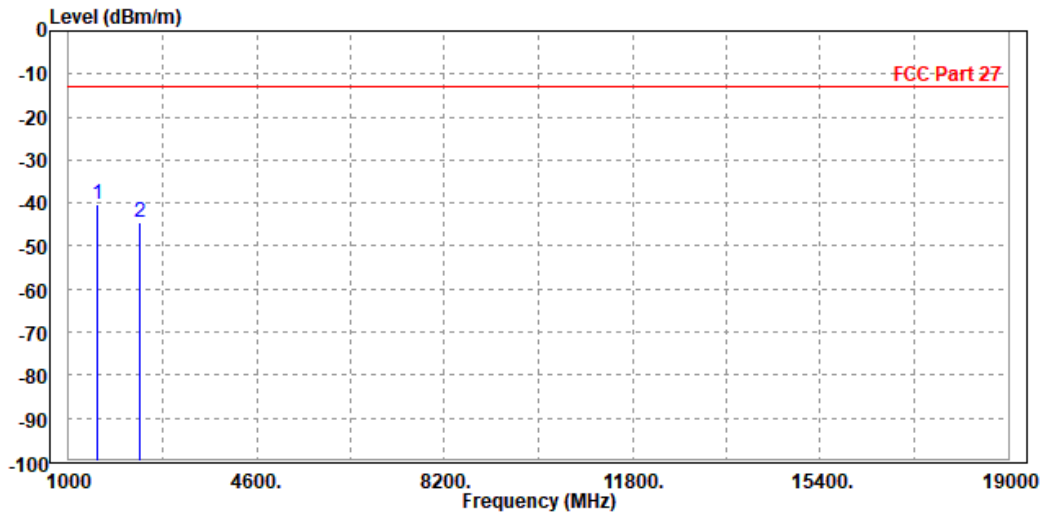



CH 23255

MODE	TX channel 23255	FREQUENCY RANGE	Above 1000MHz
ENVIRONMENTAL CONDITIONS	23deg. C, 70%RH	INPUT POWER	DC 3.7V by battery
TESTED BY	Star Le		
ANTENNA POLARITY & TEST DISTANCE: HORIZONTAL AT 3 M			

	Freq	Level	Read Level	Limit Line	Over Limit	Factor	Remark	Pol/Phase
	MHz	dBm/m	dBm	dBm/m	dB	dB/m		
1	1576.000	-37.70	-40.07	-13.00	-24.70	2.37	Peak	Horizontal
2 PP	2353.500	-33.17	-41.07	-13.00	-20.17	7.90	Peak	Horizontal

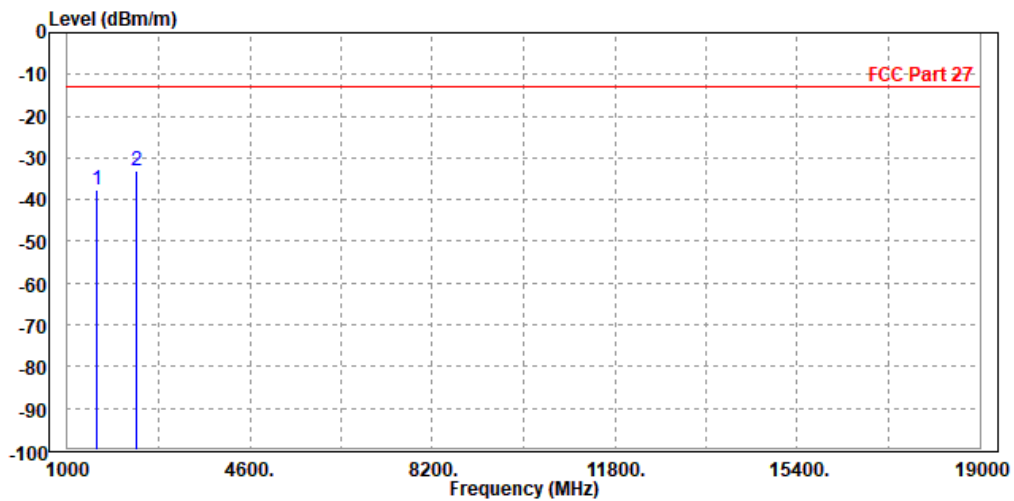



MODE	TX channel 23255	FREQUENCY RANGE	Above 1000MHz
ENVIRONMENTAL CONDITIONS	23deg. C, 70%RH	INPUT POWER	DC 3.7V by battery
TESTED BY	Star Le		
ANTENNA POLARITY & TEST DISTANCE: VERTICAL AT 3 M			

	Freq	Level	Read Level	Limit Line	Over Limit	Factor	Remark	Pol/Phase
	MHz	dBm/m	dBm	dBm/m	dB	dB/m		
1	1576.000	-42.36	-45.09	-13.00	-29.36	2.73	Peak	Vertical
2	PP 2353.500	-41.59	-48.51	-13.00	-28.59	6.92	Peak	Vertical

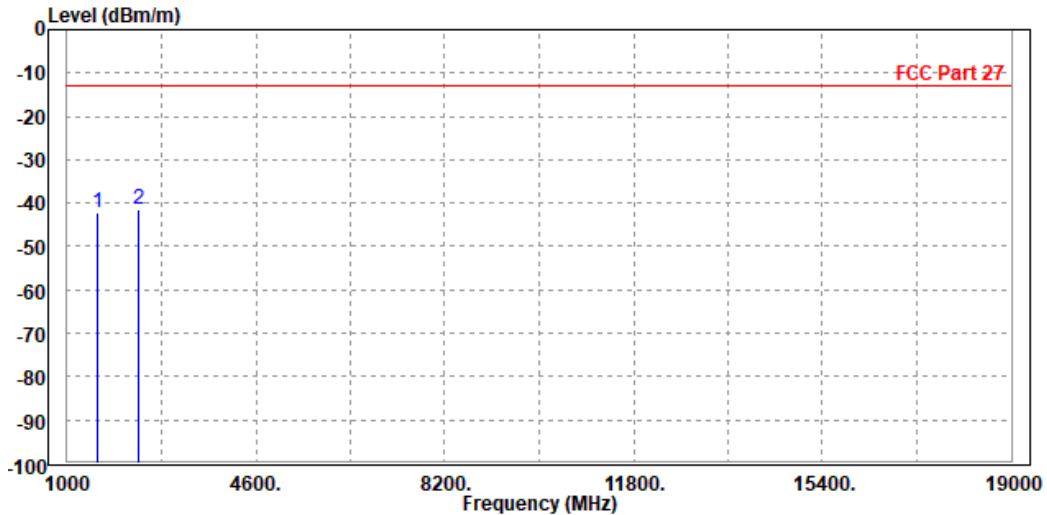



CHANNEL BANDWIDTH: 10MHz / QPSK

MODE	TX channel 23230	FREQUENCY RANGE	Above 1000MHz
ENVIRONMENTAL CONDITIONS	23deg. C, 70%RH	INPUT POWER	DC 3.7V by battery
TESTED BY	Star Le		
ANTENNA POLARITY & TEST DISTANCE: HORIZONTAL AT 3 M			

	Freq	Level	Read Level	Limit Line	Over Limit	Factor	Remark	Pol/Phase
	MHz	dBm/m	dBm	dBm/m	dB	dB/m		
1	1558.000	-34.06	-36.21	-13.00	-21.06	2.15	Peak	Horizontal
2 PP	2346.000	-33.28	-41.18	-13.00	-20.28	7.90	Peak	Horizontal

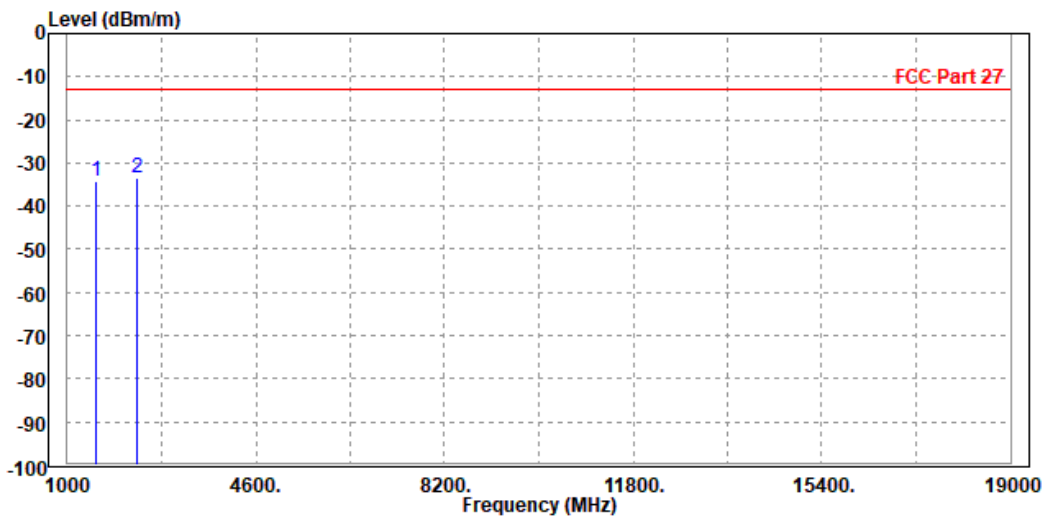



MODE	TX channel 23230	FREQUENCY RANGE	Above 1000MHz
ENVIRONMENTAL CONDITIONS	23deg. C, 70%RH	INPUT POWER	DC 3.7V by battery
TESTED BY	Star Le		
ANTENNA POLARITY & TEST DISTANCE: VERTICAL AT 3 M			

	Freq	Level	Read Level	Limit Line	Over Limit	Factor	Remark	Pol/Phase
	MHz	dBm/m	dBm	dBm/m	dB	dB/m		
1	1558.000	-41.07	-43.64	-13.00	-28.07	2.57	Peak	Vertical
2 PP	2346.000	-39.67	-46.58	-13.00	-26.67	6.91	Peak	Vertical

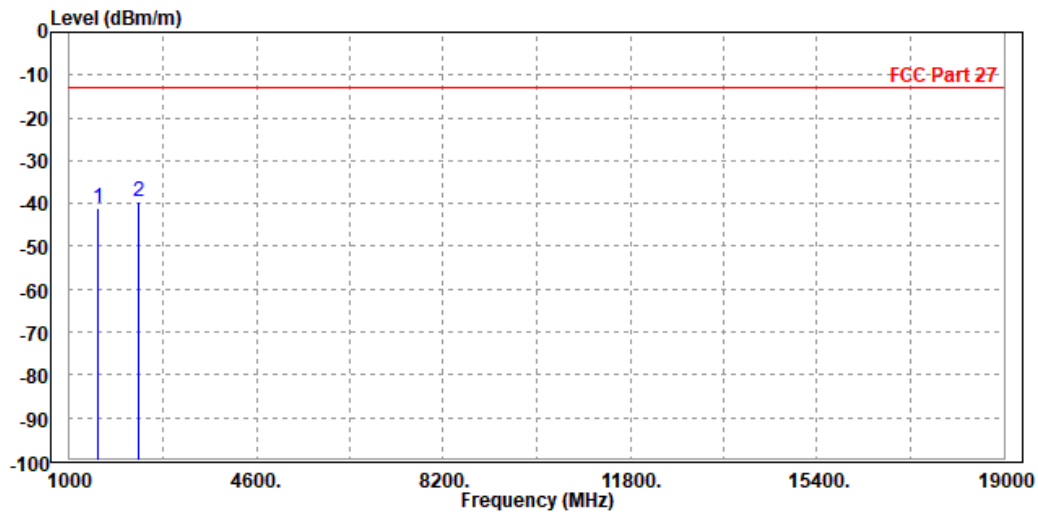



4 INFORMATION ON THE TESTING LABORATORIES

We, BV 7Layers Communications Technology (Shenzhen) Co. Ltd, were founded in 2015 to provide our best service in EMC, Radio, and Telecom. Our laboratories are accredited and approved according to ISO/IEC 17025.

If you have any comments, please feel free to contact us at the following:

Shenzhen EMC/RF Lab:

Tel: +86 755 8869 6566

Fax: +86 755 8869 6577

Email: customerservice.dg@cn.bureauveritas.com

Web Site: www.adt.com.tw

The address and road map of all our labs can be found in our web site also.



5 APPENDIX A – MODIFICATIONS RECORDERS FOR ENGINEERING CHANGES TO THE EUT BY THE LAB

No modifications were made to the EUT by the lab during the test.

---END---