





**BUREAU
VERITAS**

Test Report No.:RD2312WDG0147

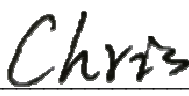

Certificate # 2951.01

Test Report No.: RD2312WDG0147	
Applicant's name :	Particle Industries, Inc
Address :	325 9th St, San Francisco, CA 94103 USA,415-319-1553
Test item description:	M SoM
Model/Type reference :	M404
Testing laboratory	
Name :	Bureau Veritas Shenzhen Co., Ltd. Dongguan Branch
Address :	No. 96, Guantai Road (Houjie Section), Houjie Town, Dongguan City, Guangdong Province, 523942, People's Republic of China
Test specification	
Standard :	<input checked="" type="checkbox"/> IEC 62368-1: 2018 <input checked="" type="checkbox"/> EN IEC 62368-1:2020+A11:2020 <input type="checkbox"/> BS EN IEC 62368-1:2020+A11:2020
Test Result :	The sample satisfies to the clauses examined.
Prepared By :	
 <hr style="width: 20%; margin: auto;"/>	
Chris Feng Engineer / Safety Department	<u>2024-01-25</u> Date
Approved By:	
 <hr style="width: 20%; margin: auto;"/>	
Jetter Yang Senior Engineer / Safety Department	<u>2024-01-25</u> Date
<p>This report is governed by, and incorporates by reference, the Conditions of Testing as posted at the date of issuance of this report at http://www.bureauveritas.com/home/about-us/our-business/cps/about-us/terms-conditions/ and is intended for your exclusive use. Any copying or replication of this report to or for any other person or entity, or use of our name or trademark, is permitted only with our prior written permission. This report sets forth our findings solely with respect to the test samples identified herein. The results set forth in this report are not indicative or representative of the quality or characteristics of the lot from which a test sample was taken or any similar or identical product unless specifically and expressly noted. Our report includes all of the tests requested by you and the results thereof based upon the information that you provided to us. Measurement uncertainty is only provided upon request for accredited tests. Statements of conformity are based on simple acceptance criteria without taking measurement uncertainty into account, unless otherwise requested in writing. You have 60 days from date of issuance of this report to notify us of any material error or omission caused by our negligence or if you require measurement uncertainty; provided, however, that such notice shall be in writing and shall specifically address the issue you wish to raise. A failure to raise such issue within the prescribed time shall constitute your unqualified acceptance of the completeness of this report, the tests conducted and the correctness of the report contents.</p>	



TEST REPORT

Report Number..... : RD2312WDG0147

Date of issue : 2024.01.25

Total number of pages : 79

Testing laboratory : **Bureau Veritas Shenzhen Co., Ltd. Dongguan Branch**

Test location/Address : No. 96, Guantai Road (Houjie Section), Houjie Town,
Dongguan City, Guangdong Province, 523942, People's
Republic of China

Applicant's name : Particle Industries, Inc

Address..... : 325 9th St, San Francisco, CA 94103 USA,415-319-1553

Test specification:

Standard : IEC 62368-1: 2018
 EN IEC 62368-1:2020+A11:2020
 BS EN IEC 62368-1:2020+A11:2020

Non-standard test method : N/A

Test Report Form No. : IEC/EN 62368-1(ed.3.0)_DG_V202102

Test Report Form(s) Originator : BV_DG

Master TRF : Dated 2021-02

Manufacturer : Particle Industries, Inc

Address..... : 325 9th St, San Francisco, CA 94103 USA,415-319-1553

Factory : Wistron NeWeb Corp

Address..... : 20 Park Avenue II, Hsinchu Science Park Hsinchu 308,
Taiwan, R.O.C.

Test item description..... : M SoM

Trade Mark..... : 

Model/Type reference..... : M404

Ratings..... : VCC:3.8Vdc; 3V3:3.3Vdc



Copy of marking plate:

The artwork below may be only a draft. The use of certification marks on a product must be authorized by the respective NCBs that own these marks.



Note: The instruction sheet and marking should be translated to the language where the product will be sold. The model no. can be replaced by other ones listed in this report.



WEEE logo (crossed-out wheeled bin symbol with solid bar): at least 7 mm in height.



TEST ITEM PARTICULARS:	
Product group	<input type="checkbox"/> end product <input checked="" type="checkbox"/> built-in component
Classification of use by.....	<input type="checkbox"/> Ordinary person <input type="checkbox"/> Children likely present <input type="checkbox"/> Instructed person <input checked="" type="checkbox"/> Skilled person
Supply connection.....	<input type="checkbox"/> AC mains <input type="checkbox"/> DC mains <input checked="" type="checkbox"/> not mains connected: <input checked="" type="checkbox"/> ES1 <input type="checkbox"/> ES2 <input type="checkbox"/> ES3
Supply tolerance	<input type="checkbox"/> +10%/-10% <input type="checkbox"/> +20%/-15% <input type="checkbox"/> + %/ - % <input checked="" type="checkbox"/> None
Supply connection – type	<input type="checkbox"/> pluggable equipment type A - <input type="checkbox"/> non-detachable supply cord <input type="checkbox"/> appliance coupler <input type="checkbox"/> direct plug-in <input type="checkbox"/> pluggable equipment type B - <input type="checkbox"/> non-detachable supply cord <input type="checkbox"/> appliance coupler <input type="checkbox"/> permanent connection <input type="checkbox"/> mating connector <input checked="" type="checkbox"/> other: Supply by DC sources
Considered current rating of protective device.....	<input type="checkbox"/> A; Location: <input type="checkbox"/> building <input type="checkbox"/> equipment <input checked="" type="checkbox"/> N/A
Equipment mobility	<input type="checkbox"/> movable <input type="checkbox"/> hand-held <input type="checkbox"/> transportable <input type="checkbox"/> direct plug-in <input type="checkbox"/> stationary <input checked="" type="checkbox"/> for building-in <input type="checkbox"/> wall/ceiling-mounted <input type="checkbox"/> SRME/rack-mounted <input type="checkbox"/> other:
Overvoltage category (OVC)	<input type="checkbox"/> OVC I <input type="checkbox"/> OVC II <input type="checkbox"/> OVC III <input type="checkbox"/> OVC IV <input checked="" type="checkbox"/> other:supply by DC sources
Class of equipment	<input type="checkbox"/> Class I <input type="checkbox"/> Class II <input checked="" type="checkbox"/> Class III <input type="checkbox"/> Not classified <input type="checkbox"/>
Special installation location	<input checked="" type="checkbox"/> N/A <input type="checkbox"/> restricted access area <input type="checkbox"/> outdoor location <input type="checkbox"/>
Pollution degree (PD)	<input type="checkbox"/> PD 1 <input checked="" type="checkbox"/> PD 2 <input type="checkbox"/> PD 3
Manufacturer's specified T _{ma}	60 °C <input type="checkbox"/> Outdoor: minimum °C
IP protection class	<input checked="" type="checkbox"/> IPX0 <input type="checkbox"/> IP__
Power systems	<input type="checkbox"/> TN <input type="checkbox"/> TT <input type="checkbox"/> IT - V _{L-L} <input checked="" type="checkbox"/> not AC mains
Altitude during operation (m)	<input checked="" type="checkbox"/> 2000 m or less <input type="checkbox"/> m
Altitude of test laboratory (m)	<input checked="" type="checkbox"/> 2000 m or less <input type="checkbox"/> m
Mass of equipment (kg)	25.7g



Possible test case verdicts:	
- test case does not apply to the test object	N/A
- test object does meet the requirement	P (Pass)
- test object does not meet the requirement	F (Fail)
Testing:	
Date of receipt of test item	2023-12-19
Date (s) of performance of tests	2023-12-19 to 2024-01-05
General remarks:	
<p>"(See Enclosure #)" refers to additional information appended to the report. "(See appended table)" refers to a table appended to the report.</p> <p>Throughout this report a <input type="checkbox"/> comma / <input checked="" type="checkbox"/> point is used as the decimal separator.</p>	
Summary of testing:	
<p>All tests were measured under the worst case and the load conditions used during testing are: -Refer B.2.5 for details.</p>	
General product information and other remarks:	
<ol style="list-style-type: none"> The equipment is "M SoM" which is supplied by DC source. This is a built-in circuit board, without any enclosure, all electronic components are mounted on the PCB. Physical size: approximate 78.8mm x 46.9 x 10.7mm The equipment will consider more in the product. 	



OVERVIEW OF ENERGY SOURCES AND SAFEGUARDS				
Clause	Possible Hazard			
5	Electrically-caused injury			
Class and Energy Source (e.g. ES3: Primary circuit)	Body Part (e.g. Ordinary)	Safeguards		
		B	S	R
ES1: All parts of unit(M 404) (VCC:3.8Vdc; 3V3:3.3Vdc)	Ordinary	N/A	N/A	N/A
6	Electrically-caused fire			
Class and Energy Source (e.g. PS2: 100 Watt circuit)	Material part (e.g. Printed board)	Safeguards		
		B	1 st S	2 nd S
PS2: All parts of EUT	Combustible materials within equipment	No ignition and no part attainable high temperature value	Control fire spread, all components are mounted on the V-1 or better PCB	N/A
7	Injury caused by hazardous substances			
Class and Energy Source (e.g. Ozone)	Body Part (e.g., Skilled)	Safeguards		
		B	S	R
N/A	N/A	N/A	N/A	N/A
8	Mechanically-caused injury			
Class and Energy Source (e.g. MS3: Plastic fan blades)	Body Part (e.g. Ordinary)	Safeguards		
		B	S	R
MS1: Sharp edges and corners	Ordinary	N/A	N/A	N/A
MS1: Mass of equipment- Approximate 25.7g<7kg	Ordinary	N/A	N/A	N/A
9	Thermal burn			
Class and Energy Source (e.g. TS1: Keyboard caps)	Body Part (e.g., Ordinary)	Safeguards		
		B	S	R
TS1: Accessible surface	Ordinary	N/A	N/A	N/A
10	Radiation			
Class and Energy Source (e.g. RS1: PMP sound output)	Body Part (e.g., Ordinary)	Safeguards		
		B	S	R
N/A	Ordinary	N/A	N/A	N/A



BUREAU
VERITAS Test Report No.:RD2312WDG0147

Supplementary Information:

“B” – Basic Safeguard; “S” – Supplementary Safeguard; “R” – Reinforced Safeguard



ENERGY SOURCE DIAGRAM

Optional. Manufacturers are to provide the energy sources diagram identify declared energy sources and identifying the demarcations are between power sources. Recommend diagram be provided included in power supply and multipart systems.

Insert diagram below. Example diagram designs are; Block diagrams; image(s) with layered data; mechanical drawings

ES PS MS TS RS

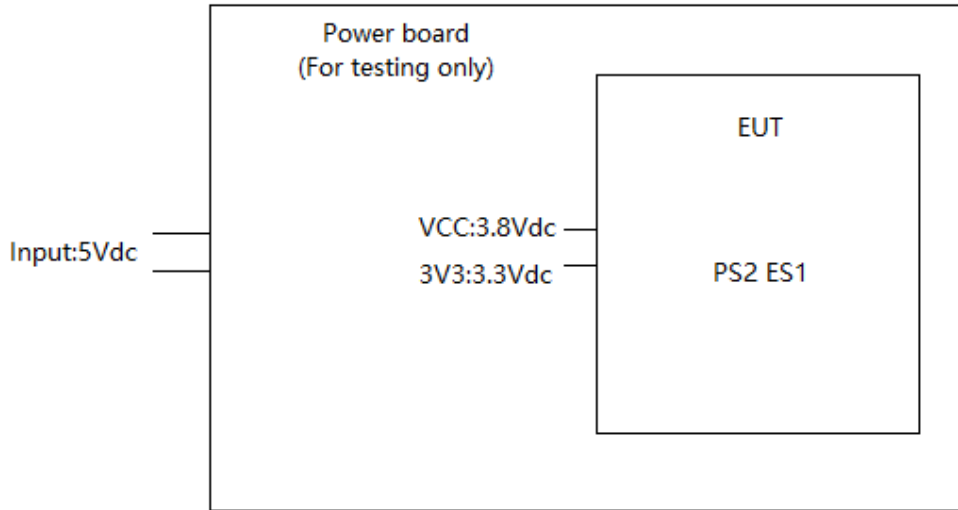

ES1:All parts within EUT;
 PS2: All parts within EUT;
 MS1:Edges and corners of product;
 TS1: Accessible surface of EUT;



IEC/EN 62368-1

Clause	Requirement + Test	Result - Remark	Verdict
4	GENERAL REQUIREMENTS		P
4.1.1	Acceptance of materials, components and subassemblies	(See appended table 4.1.2)	P
4.1.2	Use of components	Components which are certified to IEC and/or national standards are used correctly within their ratings. Components not covered by IEC standards are tested under the conditions present in the equipment. See also Annex G.	P
4.1.3	Equipment design and construction	Building-in equipment, it shall be evaluated in the end product.	P
4.1.4	Specified ambient temperature for outdoor use (°C)	Not such equipment	N/A
4.1.5	Constructions and components not specifically covered	No such construction and component	N/A
4.1.8	Liquids and liquid filled components (LFC)	No such part	N/A
4.1.15	Markings and instructions	(See Annex F)	P
4.4.3	Safeguard robustness	Evaluated in the end system	N/A
4.4.3.1	General		N/A
4.4.3.2	Steady force tests	Evaluated in the end system	N/A
4.4.3.3	Drop tests	Evaluated in the end system	N/A
4.4.3.4	Impact tests	Evaluated in the end system	N/A
4.4.3.5	Internal accessible safeguard tests	Evaluated in the end system	N/A
4.4.3.6	Glass impact tests	No such part	N/A
4.4.3.7	Glass fixation tests	No such part	N/A
	Glass impact test (1J)	No such part	N/A
	Push/pull test (10 N)	No such part	N/A
4.4.3.8	Thermoplastic material tests	Evaluated in the end system	N/A
4.4.3.9	Air comprising a safeguard	No such air comprising safeguard	N/A
4.4.3.10	Accessibility, glass, safeguard effectiveness	No such part	N/A
4.4.4	Displacement of a safeguard by an insulating liquid		N/A



IEC/EN 62368-1			
Clause	Requirement + Test	Result - Remark	Verdict
4.4.5	Safety interlocks	No such part	N/A
4.5	Explosion		P
4.5.1	General	No explosion occurs during normal/abnormal operation and single fault conditions.	P
4.5.2	No explosion during normal/abnormal operating condition	(See Clause B.2, B.3)	P
	No harm by explosion during single fault conditions	(See Clause B.4)	P
4.6	Fixing of conductors		N/A
	Fix conductors not to defeat a safeguard	Supplied by ES1 circuit and no such safeguard requirement	N/A
	Compliance is checked by test.....:	Supplied by ES1 circuit and no such safeguard requirement	N/A
4.7	Equipment for direct insertion into mains socket-outlets		N/A
4.7.2	Mains plug part complies with relevant standard:	Not such equipment	N/A
4.7.3	Torque (Nm):	Not such equipment	N/A
4.8	Equipment containing coin/button cell batteries		N/A
4.8.1	General		N/A
4.8.2	Instructional safeguard:		N/A
4.8.3	Battery compartment door/cover construction		N/A
	Open torque test		N/A
4.8.4.2	Stress relief test		N/A
4.8.4.3	Battery replacement test		N/A
4.8.4.4	Drop test		N/A
4.8.4.5	Impact test		N/A
4.8.4.6	Crush test		N/A
4.8.5	Compliance		N/A
	30N force test with test probe		N/A
	20N force test with test hook		N/A
4.9	Likelihood of fire or shock due to entry of conductive object		N/A
4.10	Component requirements		N/A



IEC/EN 62368-1			
Clause	Requirement + Test	Result - Remark	Verdict
4.10.1	Disconnect Device	(See Annex L)	N/A
4.10.2	Switches and relays	(See Annex G)	N/A

5	ELECTRICALLY-CAUSED INJURY		P
5.2	Classification and limits of electrical energy sources		P
5.2.2	ES1, ES2 and ES3 limits	All parts complied with ES1	P
5.2.2.2	Steady-state voltage and current limits	(See appended table 5.2)	P
5.2.2.3	Capacitance limits	No such capacitance	N/A
5.2.2.4	Single pulse limits.....	No such pulse	N/A
5.2.2.5	Limits for repetitive pulses.....	No such pulse	N/A
5.2.2.6	Ringling signals	No such ringing signals	N/A
5.2.2.7	Audio signals	No such pulse	N/A
5.3	Protection against electrical energy sources		N/A
5.3.1	General Requirements for accessible parts to ordinary, instructed and skilled persons	Class III equipment and all electrical circuits of EUT are ES1.	N/A
5.3.1 a)	Accessible ES1/ES2 derived from ES2/ES3 circuits	Class III equipment and all electrical circuits of EUT are ES1.	N/A
5.3.1 b)	Skilled persons not unintentional contact ES3 bare conductors	Class III equipment and all electrical circuits of EUT are ES1.	N/A
5.3.2.1	Accessibility to electrical energy sources and safeguards	Class III equipment and all electrical circuits of EUT are ES1.	N/A
	Accessibility to outdoor equipment bare parts	Class III equipment and all electrical circuits of EUT are ES1.	N/A
5.3.2.2	Contact requirements	Class III equipment and all electrical circuits of EUT are ES1.	N/A
	Test with test probe from Annex V	Class III equipment and all electrical circuits of EUT are ES1.	—
5.3.2.2 a)	Air gap – electric strength test potential (V)		N/A
5.3.2.2 b)	Air gap – distance (mm)		N/A
5.3.2.3	Compliance	Class III equipment and all electrical circuits of EUT are ES1.	N/A
5.3.2.4	Terminals for connecting stripped wire	No such part	N/A
5.4	Insulation materials and requirements		N/A



IEC/EN 62368-1			
Clause	Requirement + Test	Result - Remark	Verdict
5.4.1.2	Properties of insulating material	No such material used.	N/A
5.4.1.3	Material is non-hygroscopic		N/A
5.4.1.4	Maximum operating temperature for insulating materials	ES1 electrical energy source, no such insulating material used	N/A
5.4.1.5	Pollution degrees	Pollution degree 2	N/A
5.4.1.5.2	Test for pollution degree 1 environment and for an insulating compound		N/A
5.4.1.5.3	Thermal cycling test		N/A
5.4.1.6	Insulation in transformers with varying dimensions	No such device	N/A
5.4.1.7	Insulation in circuits generating starting pulses	No such pulses occurred	N/A
5.4.1.8	Determination of working voltage	Class III equipment and all electrical circuits of EUT are ES1	N/A
5.4.1.9	Insulating surfaces	No such construction	N/A
5.4.1.10	Thermoplastic parts on which conductive metallic parts are directly mounted	No such part	N/A
5.4.1.10.2	Vicat test	No such part	N/A
5.4.1.10.3	Ball pressure test	No such part	N/A
5.4.2	Clearances	Not directly connected to mains and only ES1 inside the EUT.	N/A
5.4.2.1	General requirements		N/A
	Clearances in circuits connected to AC Mains, Alternative method		N/A
5.4.2.2	Procedure 1 for determining clearance		N/A
	Temporary overvoltage		—
5.4.2.3	Procedure 2 for determining clearance		N/A
5.4.2.3.2.2	a.c. mains transient voltage		—
5.4.2.3.2.3	d.c. mains transient voltage		—
5.4.2.3.2.4	External circuit transient voltage		—
5.4.2.3.2.5	Transient voltage determined by measurement ..		—
5.4.2.4	Determining the adequacy of a clearance using an electric strength test	ES1 electrical energy source used, only the functional insulation inside the EUT	N/A



IEC/EN 62368-1

Clause	Requirement + Test	Result - Remark	Verdict
5.4.2.5	Multiplication factors for clearances and test voltages	Only considered less the 2000m in this report	N/A
5.4.2.6	Clearance measurement	ES1 electrical energy source used, only the functional insulation inside the EUT	N/A
5.4.3	Creepage distances	ES1 electrical energy source used, only the functional insulation inside the EUT	N/A
5.4.3.1	General	ES1 electrical energy source used, only the functional insulation inside the EUT	N/A
5.4.3.3	Material group	Group IIIb	—
5.4.3.4	Creepage distances measurement	ES1 electrical energy source used, only the functional insulation inside the EUT	N/A
5.4.4	Solid insulation	Class III equipment and all electrical circuits of EUT are ES1, and there is no critical insulation.	N/A
5.4.4.1	General requirements		N/A
5.4.4.2	Minimum distance through insulation	ES1 electrical energy source used, only the functional insulation inside the EUT	N/A
5.4.4.3	Insulating compound forming solid insulation	No such part	N/A
5.4.4.4	Solid insulation in semiconductor devices	No such part	N/A
5.4.4.5	Insulating compound forming cemented joints	No such part	N/A
5.4.4.6	Thin sheet material	No such part	N/A
5.4.4.6.1	General requirements	No such part	N/A
5.4.4.6.2	Separable thin sheet material	No such part	N/A
	Number of layers (pcs)	No such part	N/A
5.4.4.6.3	Non-separable thin sheet material	No such part	N/A
	Number of layers (pcs)	No such part	N/A
5.4.4.6.4	Standard test procedure for non-separable thin sheet material	No such part	N/A
5.4.4.6.5	Mandrel test	No such part	N/A
5.4.4.7	Solid insulation in wound components	No such part	N/A



IEC/EN 62368-1			
Clause	Requirement + Test	Result - Remark	Verdict
5.4.4.9	Solid insulation at frequencies >30 kHz, EP, KR, d, VPW (V).....:	No such part	N/A
	Alternative by electric strength test, tested voltage (V), KR.....:	No such part	N/A
5.4.5	Antenna terminal insulation	No such antenna	N/A
5.4.5.1	General	No such antenna	N/A
5.4.5.2	Voltage surge test		N/A
5.4.5.3	Insulation resistance (MΩ)		N/A
	Electric strength test.....:		N/A
5.4.6	Insulation of internal wire as part of supplementary safeguard		N/A
5.4.7	Tests for semiconductor components and for cemented joints	No such components used.	N/A
5.4.8	Humidity conditioning	ES1 electrical energy source used, only the functional insulation inside the EUT	N/A
	Relative humidity (%), temperature (°C), duration (h)		—
5.4.9	Electric strength test	ES1 electrical energy source used, only the functional insulation inside the EUT	N/A
5.4.9.1	Test procedure for type test of solid insulation.....:	ES1 electrical energy source used, only the functional insulation inside the EUT	N/A
5.4.9.2	Test procedure for routine test	Class III equipment and all electrical circuits of EUT are ES1, only the functional insulation inside the EUT	N/A
5.4.10	Safeguards against transient voltages from external circuits	The EUT does not intend to be connected directly such external circuits	N/A
5.4.10.1	Parts and circuits separated from external circuits	The EUT does not intend to be connected directly such external circuits	N/A
5.4.10.2	Test methods		N/A
5.4.10.2.1	General		N/A
5.4.10.2.2	Impulse test	No transient voltage from the external circuit	N/A



IEC/EN 62368-1			
Clause	Requirement + Test	Result - Remark	Verdict
5.4.10.2.3	Steady-state test	No transient voltage from the external circuit	N/A
5.4.10.3	Verification for insulation breakdown for impulse test.....		N/A
5.4.11	Separation between external circuits and earth	The EUT does not intend to be connected directly such external circuits	N/A
5.4.11.1	Exceptions to separation between external circuits and earth	The EUT does not intend to be connected directly such external circuits	N/A
5.4.11.2	Requirements	No SPD used	N/A
	SPDs bridge separation between external circuit and earth	No SPD used	N/A
	Rated operating voltage U_{op} (V).....	No SPD used	—
	Nominal voltage U_{peak} (V)	No SPD used	—
	Max increase due to variation ΔU_{sp}	No SPD used	—
	Max increase due to ageing ΔU_{sa}	No SPD used	—
5.4.11.3	Test method and compliance		N/A
5.4.12	Insulating liquid	No such part	N/A
5.4.12.1	General requirements	No such part	N/A
5.4.12.2	Electric strength of an insulating liquid.....	No such part	N/A
5.4.12.3	Compatibility of an insulating liquid	No such part	N/A
5.4.12.4	Container for insulating liquid	No such part	N/A
5.5	Components as safeguards		N/A
5.5.1	General	No such components	N/A
5.5.2	Capacitors and RC units	No such components	N/A
5.5.2.1	General requirement	No such components	N/A
5.5.2.2	Safeguards against capacitor discharge after disconnection of a connector.....	No such components	N/A
5.5.3	Transformers	No such components	N/A
5.5.4	Optocouplers	No such components	N/A
5.5.5	Relays	No such components	N/A
5.5.6	Resistors	No such components	N/A



IEC/EN 62368-1			
Clause	Requirement + Test	Result - Remark	Verdict
5.5.7	SPDs	The EUT does not intend to connect mains directly	N/A
5.5.8	Insulation between the mains and an external circuit consisting of a coaxial cable	No such device	N/A
5.5.9	Safeguards for socket-outlets in outdoor equipment		—
	RCD rated residual operating current (mA).....	No such components	N/A
5.6	Protective conductor		N/A
5.6.2	Requirement for protective conductors		N/A
5.6	Protective conductor	No such device	N/A
5.6.2	Requirement for protective conductors	No such device	N/A
5.6.2.1	General requirements	No such device	N/A
5.6.2.2	Colour of insulation	No such device	N/A
5.6.3	Requirement for protective earthing conductors	No such device	N/A
	Protective earthing conductor size (mm ²)	No such device	—
	Protective earthing conductor serving as a reinforced safeguard	No such device	N/A
	Protective earthing conductor serving as a double safeguard	No such device	N/A
5.6.4	Requirements for protective bonding conductors	No such device	N/A
5.6.4.1	Protective bonding conductors	No such device	N/A
	Protective bonding conductor size (mm ²).....	No such device	—
5.6.4.2	Protective current rating (A)	No such device	N/A
5.6.5	Terminals for protective conductors	No such device	N/A
5.6.5.1	Terminal size for connecting protective earthing conductors (mm)	No such device	N/A
	Terminal size for connecting protective bonding conductors (mm)	No such device	N/A
5.6.5.2	Corrosion	No such device	N/A
5.6.6	Resistance of the protective bonding system	No such device	N/A
5.6.6.1	Requirements	No such device	N/A
5.6.6.2	Test Method.....	No such device	N/A



IEC/EN 62368-1			
Clause	Requirement + Test	Result - Remark	Verdict
5.6.6.3	Resistance (Ω) or voltage drop	No such device	N/A
5.6.7	Reliable connection of a protective earthing conductor	No such device	N/A
5.6.8	Functional earthing	No such device	N/A
	Conductor size (mm ²)	No such device	N/A
	Class II with functional earthing marking	No such device	N/A
	Appliance inlet cl & cr (mm).....	No such device	N/A
5.7	Prospective touch voltage, touch current and protective conductor current		N/A
5.7.2	Measuring devices and networks		N/A
5.7.2.1	Measurement of touch current	Supplied by ES1 electrical energy source	N/A
5.7.2.2	Measurement of voltage	Supplied by ES1 electrical energy source	N/A
5.7.3	Equipment set-up, supply connections and earth connections	Supplied by ES1 electrical energy source	N/A
5.7.4	Unearthed accessible parts.....	Supplied by ES1 electrical energy source	N/A
5.7.5	Earthed accessible conductive parts.....	Supplied by ES1 electrical energy source	N/A
5.7.6	Requirements when touch current exceeds ES2 limits		N/A
	Protective conductor current (mA)	No protective conductor	N/A
	Instructional Safeguard		N/A
5.7.7	Prospective touch voltage and touch current associated with external circuits	The equipment does not intend to be connected to such external circuit	N/A
5.7.7.1	Touch current from coaxial cables	The equipment does not intend to be connected to coaxial cable	N/A
5.7.7.2	Prospective touch voltage and touch current associated with paired conductor cables		N/A
5.7.8	Summation of touch currents from external circuits	The equipment does not intend to be connected to such external circuit	N/A
	a) Equipment connected to earthed external circuits, current (mA)	The equipment does not intend to be connected to such external circuit	N/A



IEC/EN 62368-1

Clause	Requirement + Test	Result - Remark	Verdict
	b) Equipment connected to unearthed external circuits, current (mA)	The equipment does not intend to be connected to such external circuit	N/A
5.8	Backfeed safeguard in battery backed up supplies		N/A
	Mains terminal ES	No such device	N/A
	Air gap (mm)		N/A

6	ELECTRICALLY- CAUSED FIRE		P
6.2	Classification of PS and PIS		P
6.2.2	Power source circuit classifications	All circuits complied with PS2	P
6.2.3	Classification of potential ignition sources	See below	P
6.2.3.1	Arcing PIS	No arcing PIS due to no part with voltage 50V in the equipment.	N/A
6.2.3.2	Resistive PIS	(See appended table 6.2.3.2)	P
6.3	Safeguards against fire under normal operating and abnormal operating conditions		P
6.3.1	No ignition and attainable temperature value less than 90 % defined by ISO 871 or less than 300 °C for unknown materials	No ignition and attainable such temperature value	P
	Combustible materials outside fire enclosure.....	No such materials used	N/A
6.4	Safeguards against fire under single fault conditions		P
6.4.1	Safeguard method	Control fire spread considered	P
6.4.2	Reduction of the likelihood of ignition under single fault conditions in PS1 circuits		N/A
6.4.3	Reduction of the likelihood of ignition under single fault conditions in PS2 and PS3 circuits		N/A
6.4.3.1	Supplementary safeguards		N/A
6.4.3.2	Single Fault Conditions.....		N/A
	Special conditions for temperature limited by fuse		N/A
6.4.4	Control of fire spread in PS1 circuits		N/A
6.4.5	Control of fire spread in PS2 circuits	See below	P
6.4.5.2	Supplementary safeguards	All components are mounted on the V-1 or better PCB materials	P
6.4.6	Control of fire spread in PS3 circuits	No PS3 circuits inside EUT.	N/A



IEC/EN 62368-1			
Clause	Requirement + Test	Result - Remark	Verdict
6.4.7	Separation of combustible materials from a PIS		N/A
6.4.7.2	Separation by distance		N/A
6.4.7.3	Separation by a fire barrier	No such part	N/A
6.4.8	Fire enclosures and fire barriers	No fire enclosure and fire barrier required	N/A
6.4.8.2	Fire enclosure and fire barrier material properties		N/A
6.4.8.2.1	Requirements for a fire barrier		N/A
6.4.8.2.2	Requirements for a fire enclosure		N/A
6.4.8.3	Constructional requirements for a fire enclosure and a fire barrier		N/A
6.4.8.3.1	Fire enclosure and fire barrier openings		N/A
6.4.8.3.2	Fire barrier dimensions		N/A
6.4.8.3.3	Top openings and properties		N/A
	Openings dimensions (mm)..... :		N/A
6.4.8.3.4	Bottom openings and properties		N/A
	Openings dimensions (mm)..... :		N/A
	Flammability tests for the bottom of a fire enclosure		N/A
	Instructional Safeguard..... :		N/A
6.4.8.3.5	Side openings and properties		N/A
	Openings dimensions (mm)..... :		N/A
6.4.8.3.6	Integrity of a fire enclosure, condition met: a), b) or c)..... :		N/A
6.4.8.4	Separation of a PIS from a fire enclosure and a fire barrier distance (mm) or flammability rating . :		N/A
6.4.9	Flammability of insulating liquid..... :	No insulating liquid	N/A
6.5	Internal and external wiring		N/A
6.5.1	General requirements		N/A
6.5.2	Requirements for interconnection to building wiring :		N/A
6.5.3	Internal wiring size (mm ²) for socket-outlets..... :		N/A
6.6	Safeguards against fire due to the connection to additional equipment		N/A



IEC/EN 62368-1

Clause	Requirement + Test	Result - Remark	Verdict
--------	--------------------	-----------------	---------

7	INJURY CAUSED BY HAZARDOUS SUBSTANCES		P
7.2	Reduction of exposure to hazardous substances		P
7.3	Ozone exposure		N/A
7.4	Use of personal safeguards or personal protective equipment (PPE)		N/A
	Personal safeguards and instructions	The equipment doesn't produces hazardous substance	—
7.5	Use of instructional safeguards and instructions		N/A
	Instructional safeguard (ISO 7010).....	The equipment doesn't produces hazardous substance	—
7.6	Batteries and their protection circuits		N/A

8	MECHANICALLY-CAUSED INJURY		P
8.2	Mechanical energy source classifications		P
8.3	Safeguards against mechanical energy sources		N/A
8.4	Safeguards against parts with sharp edges and corners		P
8.4.1	Safeguards	No sharp edges and corners	N/A
	Instructional Safeguard.....		N/A
8.4.2	Sharp edges or corners		P
8.5	Safeguards against moving parts		N/A
8.5.1	Fingers, jewellery, clothing, hair, etc., contact with MS2 or MS3 parts		N/A
	MS2 or MS3 part required to be accessible for the function of the equipment		N/A
	Moving MS3 parts only accessible to skilled person		N/A
8.5.2	Instructional safeguard		N/A
8.5.4	Special categories of equipment containing moving parts		N/A
8.5.4.1	General		N/A
8.5.4.2	Equipment containing work cells with MS3 parts		N/A
8.5.4.2.1	Protection of persons in the work cell		N/A
8.5.4.2.2	Access protection override		N/A



IEC/EN 62368-1			
Clause	Requirement + Test	Result - Remark	Verdict
8.5.4.2.2.1	Override system		N/A
8.5.4.2.2.2	Visual indicator		N/A
8.5.4.2.3	Emergency stop system		N/A
	Maximum stopping distance from the point of activation (m) :		N/A
	Space between end point and nearest fixed mechanical part (mm) :		N/A
8.5.4.2.4	Endurance requirements		N/A
	Mechanical system subjected to 100 000 cycles of operation		N/A
	- Mechanical function check and visual inspection		N/A
	- Cable assembly :		N/A
8.5.4.3	Equipment having electromechanical device for destruction of media		N/A
8.5.4.3.1	Equipment safeguards		N/A
8.5.4.3.2	Instructional safeguards against moving parts ... :		N/A
8.5.4.3.3	Disconnection from the supply		N/A
8.5.4.3.4	Cut type and test force (N) :		N/A
8.5.4.3.5	Compliance		N/A
8.5.5	High pressure lamps		N/A
	Explosion test :		N/A
8.5.5.3	Glass particles dimensions (mm) :		N/A
8.6	Stability of equipment		N/A
8.6.1	General		N/A
	Instructional safeguard :		N/A
8.6.2	Static stability		N/A
8.6.2.2	Static stability test :		N/A
8.6.2.3	Downward force test		N/A
8.6.3	Relocation stability		N/A
	Wheels diameter (mm) :		—
	Tilt test		N/A



IEC/EN 62368-1			
Clause	Requirement + Test	Result - Remark	Verdict
8.6.4	Glass slide test		N/A
8.6.5	Horizontal force test..... :		N/A
8.7	Equipment mounted to wall, ceiling or other structure		N/A
8.7.1	Mount means type :		N/A
8.7.2	Test methods		N/A
	Test 1, additional downwards force (N) :		N/A
	Test 2, number of attachment points and test force (N) :		N/A
	Test 3 Nominal diameter (mm) and applied torque (Nm) :		N/A
8.8	Handles strength		N/A
8.8.1	General		N/A
8.8.2	Handle strength test		N/A
	Number of handles :		—
	Force applied (N) :		—
8.9	Wheels or casters attachment requirements		N/A
8.9.2	Pull test	No such part	N/A
8.10	Carts, stands and similar carriers		N/A
8.10.1	General	No such part	N/A
8.10.2	Marking and instructions..... :		N/A
8.10.3	Cart, stand or carrier loading test		N/A
	Loading force applied (N) :		N/A
8.10.4	Cart, stand or carrier impact test		N/A
8.10.5	Mechanical stability		N/A
	Force applied (N) :		—
8.10.6	Thermoplastic temperature stability		N/A
8.11	Mounting means for slide-rail mounted equipment (SRME)		N/A
8.11.1	General	No such equipment	N/A
8.11.2	Requirements for slide rails		N/A
	Instructional Safeguard..... :		N/A



IEC/EN 62368-1			
Clause	Requirement + Test	Result - Remark	Verdict
8.11.3	Mechanical strength test		N/A
8.11.3.1	Downward force test, force (N) applied :		N/A
8.11.3.2	Lateral push force test		N/A
8.11.3.3	Integrity of slide rail end stops		N/A
8.11.4	Compliance		N/A
8.12	Telescoping or rod antennas		N/A
	Button/ball diameter (mm) :	No such part	—

9	THERMAL BURN INJURY		P
9.2	Thermal energy source classifications		P
9.3	Touch temperature limits		P
9.3.1	Touch temperatures of accessible parts :	(See appended table 5.4.1.4, 9.3, B.1.5, B.2.6 and table B.3, B.4)	P
9.3.2	Test method and compliance		P
9.4	Safeguards against thermal energy sources		N/A
9.5	Requirements for safeguards		N/A
9.5.1	Equipment safeguard		N/A
9.5.2	Instructional safeguard :		N/A
9.6	Requirements for wireless power transmitters		N/A
9.6.1	General		N/A
9.6.2	Specification of the foreign objects		N/A
9.6.3	Test method and compliance :		N/A

10	RADIATION		N/A
10.2	Radiation energy source classification		N/A
10.2.1	General classification	See below	N/A
	Lasers :	No such lasers	—
	Lamps and lamp systems :	No such lamps	—
	Image projectors :	No such image projectors	—
	X-Ray :	No X-Ray	—
	Personal music player :	No such part	—



IEC/EN 62368-1

Clause	Requirement + Test	Result - Remark	Verdict
10.3	Safeguards against laser radiation		N/A
	The standard(s) equipment containing laser(s) comply	No laser radiation within the EUT.	N/A
10.4	Safeguards against optical radiation from lamps and lamp systems (including LED types)		N/A
10.4.1	General requirements		N/A
	Instructional safeguard provided for accessible radiation level needs to exceed		N/A
	Risk group marking and location		N/A
	Information for safe operation and installation		N/A
10.4.2	Requirements for enclosures		N/A
	UV radiation exposure		N/A
10.4.3	Instructional safeguard		N/A
10.5	Safeguards against X-radiation		N/A
10.5.1	Requirements		N/A
	Instructional safeguard for skilled persons		—
10.5.3	Maximum radiation (pA/kg)	(See appended tables B.3 & B.4)	—
10.6	Safeguards against acoustic energy sources		N/A
10.6.1	General		N/A
10.6.2	Classification		N/A
	Acoustic output LAeq,T, dB(A)		N/A
	Unweighted RMS output voltage (mV)		N/A
	Digital output signal (dBFS)		N/A
10.6.3	Requirements for dose-based systems		N/A
10.6.3.1	General requirements		N/A
10.6.3.2	Dose-based warning and automatic decrease		N/A
10.6.3.3	Exposure-based warning and requirements		N/A
	30 s integrated exposure level (MEL30)		N/A
	Warning for MEL ≥ 100 dB(A)		N/A
10.6.4	Measurement methods		N/A
10.6.5	Protection of persons		N/A



IEC/EN 62368-1			
Clause	Requirement + Test	Result - Remark	Verdict
	Instructional safeguards		N/A
10.6.6	Requirements for listening devices (headphones, earphones, etc.)		N/A
10.6.6.1	Corded listening devices with analogue input		N/A
	Listening device input voltage (mV)		N/A
10.6.6.2	Corded listening devices with digital input		N/A
	Max. acoustic output LAeq,T, dB(A)		N/A
10.6.6.3	Cordless listening devices		N/A
	Max. acoustic output LAeq,T, dB(A)		N/A

B	NORMAL OPERATING CONDITION TESTS, ABNORMAL OPERATING CONDITION TESTS AND SINGLE FAULT CONDITION TESTS		P
B.1	General		P
B.1.5	Temperature measurement conditions	(See appended table B.1.5)	P
B.2	Normal operating conditions		P
B.2.1	General requirements	According the standard	P
	Audio Amplifiers and equipment with audio amplifiers	No such part	N/A
B.2.3	Supply voltage and tolerances	Power board:5Vdc EUT: VCC=3.8Vdc, 3V3=3.3Vdc and no tolerance	P
B.2.5	Input test	(See appended table B.2.5)	P
B.3	Simulated abnormal operating conditions		N/A
B.3.1	General		N/A
B.3.2	Covering of ventilation openings	No ventilation openings	N/A
	Instructional safeguard		N/A
B.3.3	DC mains polarity test	Not directly connected to the DC mains.	N/A
B.3.4	Setting of voltage selector	No such component used.	N/A
B.3.5	Maximum load at output terminals	No such component used.	N/A
B.3.6	Reverse battery polarity		N/A
B.3.7	Audio amplifier abnormal operating conditions	Not such equipment.	N/A



IEC/EN 62368-1			
Clause	Requirement + Test	Result - Remark	Verdict
B.3.8	Safeguards functional during and after abnormal operating conditions	Not such equipment.	N/A
B.4	Simulated single fault conditions		P
B.4.1	General		P
B.4.2	Temperature controlling device	No such device used.	N/A
B.4.3	Blocked motor test	No motors used.	N/A
B.4.4	Functional insulation	(See appended table B.4)	P
B.4.4.1	Short circuit of clearances for functional insulation	(See appended table B.4)	P
B.4.4.2	Short circuit of creepage distances for functional insulation	(See appended table B.4)	P
B.4.4.3	Short circuit of functional insulation on coated printed boards	No coated printed boards within the EUT	N/A
B.4.5	Short-circuit and interruption of electrodes in tubes and semiconductors	(See appended table B.4)	P
B.4.6	Short circuit or disconnection of passive components	(See appended table B.4)	P
B.4.7	Continuous operation of components	The EUT is continuous operating type and no such components intended for short time operation or intermittent operation.	N/A
B.4.8	Compliance during and after single fault conditions.....	No flame produce during and after test	P
B.4.9	Battery charging and discharging under single fault conditions		N/A
C	UV RADIATION		N/A
C.1	Protection of materials in equipment from UV radiation		N/A
C.1.2	Requirements	No UV radiation	N/A
C.1.3	Test method	No UV radiation	N/A
C.2	UV light conditioning test		N/A
C.2.1	Test apparatus.....		N/A
C.2.2	Mounting of test samples		N/A
C.2.3	Carbon-arc light-exposure test		N/A
C.2.4	Xenon-arc light-exposure test		N/A



IEC/EN 62368-1			
Clause	Requirement + Test		Verdict
D	TEST GENERATORS		N/A
D.1	Impulse test generators		N/A
D.2	Antenna interface test generator		N/A
D.3	Electronic pulse generator		N/A
E	TEST CONDITIONS FOR EQUIPMENT CONTAINING AUDIO AMPLIFIERS		N/A
E.1	Electrical energy source classification for audio signals		N/A
	Maximum non-clipped output power (W)..... :	Not such equipment	—
	Rated load impedance (Ω)		—
	Open-circuit output voltage (V)..... :		—
	Instructional safeguard		—
E.2	Audio amplifier normal operating conditions		N/A
	Audio signal source type	Not such equipment	—
	Audio output power (W)..... :		—
	Audio output voltage (V)		—
	Rated load impedance (Ω)		—
	Requirements for temperature measurement		N/A
E.3	Audio amplifier abnormal operating conditions	Not such equipment	N/A
F	EQUIPMENT MARKINGS, INSTRUCTIONS, AND INSTRUCTIONAL SAFEGUARDS		P
F.1	General		P
	Language	English version provided. (Version in other language will be provided when submitted for national approval)	—
F.2	Letter symbols and graphical symbols		P
F.2.1	Letter symbols according to IEC60027-1	Letter symbols for quantities and units are complied with IEC 60027-1.	P
F.2.2	Graphic symbols according to IEC, ISO or manufacturer specific	Graphical symbols are complied with IEC 60417, ISO 3864-2, ISO 7000 or ISO 7010.	P
F.3	Equipment markings		P



IEC/EN 62368-1

Clause	Requirement + Test	Result - Remark	Verdict
F.3.1	Equipment marking locations	Marked on the outside of equipment	P
F.3.2	Equipment identification markings	See below.	P
F.3.2.1	Manufacturer identification	Trademark: 	P
F.3.2.2	Model identification	Model: M404	P
F.3.3	Equipment rating markings	See below.	P
F.3.3.1	Equipment with direct connection to mains	Not direct connect to mains.	N/A
F.3.3.2	Equipment without direct connection to mains	Considered	P
F.3.3.3	Nature of the supply voltage	Not marking on the label	N/A
F.3.3.4	Rated voltage	Not marking on the label	N/A
F.3.3.5	Rated frequency	Not direct connect to the mains	—
F.3.3.6	Rated current or rated power	Not connected to mains directly	—
F.3.3.7	Equipment with multiple supply connections		N/A
F.3.4	Voltage setting device	Not such equipment.	N/A
F.3.5	Terminals and operating devices	No such devices.	N/A
F.3.5.1	Mains appliance outlet and socket-outlet markings	No mains appliance outlet and socket-outlet on the equipment.	N/A
F.3.5.2	Switch position identification marking	No switch used.	N/A
F.3.5.3	Replacement fuse identification and rating markings	No fuse used.	N/A
	Instructional safeguards for neutral fuse	No such device	N/A
F.3.5.4	Replacement battery identification marking	No replacement battery	N/A
F.3.5.5	Neutral conductor terminal	No terminal.	N/A
F.3.5.6	Terminal marking location	No such terminal	N/A
F.3.6	Equipment markings related to equipment classification	See below.	N/A
F.3.6.1	Class I equipment	Class III equipment.	N/A
F.3.6.1.1	Protective earthing conductor terminal	Class III equipment.	N/A
F.3.6.1.2	Protective bonding conductor terminals	Class III equipment.	N/A
F.3.6.2	Equipment class marking	Class III equipment.	N/A
F.3.6.3	Functional earthing terminal marking	Class III equipment.	N/A



IEC/EN 62368-1			
Clause	Requirement + Test	Result - Remark	Verdict
F.3.7	Equipment IP rating marking	Just IPX0	N/A
F.3.8	External power supply output marking	No such component.	N/A
F.3.9	Durability, legibility and permanence of marking	The marking is durable and legible, and can be easily discernible under normal lighting conditions.	P
F.3.10	Test for permanence of markings	After rubbing test by water and petroleum spirit, the label still easily discernible, indelible and legible.	P
F.4	Instructions		P
	a) Information prior to installation and initial use	Mentioned in the user manual.	P
	b) Equipment for use in locations where children not likely to be present		N/A
	c) Instructions for installation and interconnection	Mentioned in the user manual.	P
	d) Equipment intended for use only in restricted access area	Not such equipment.	N/A
	e) Equipment intended to be fastened in place	Mentioned in the user manual.	P
	f) Instructions for audio equipment terminals	Class III equipment.	N/A
	g) Protective earthing used as a safeguard	Class III equipment.	N/A
	h) Protective conductor current exceeding ES2 limits	Not such equipment.	N/A
	i) Graphic symbols used on equipment		N/A
	j) Permanently connected equipment not provided with all-pole mains switch	No such component used.	N/A
	k) Replaceable components or modules providing safeguard function	Not such equipment.	N/A
	l) Equipment containing insulating liquid	No such part	N/A
	m) Installation instructions for outdoor equipment	Not such equipment	N/A
F.5	Instructional safeguards		N/A
G	COMPONENTS		N/A
G.1	Switches		N/A
G.1.1	General	No switch used	N/A
G.1.2	Ratings, endurance, spacing, maximum load		N/A
G.1.3	Test method and compliance		N/A



IEC/EN 62368-1			
Clause	Requirement + Test	Result - Remark	Verdict
G.2	Relays		N/A
G.2.1	Requirements	No relay used	N/A
G.2.2	Overload test		N/A
G.2.3	Relay controlling connectors supplying power to other equipment		N/A
G.2.4	Test method and compliance		N/A
G.3	Protective devices		N/A
G.3.1	Thermal cut-offs	No such device	N/A
	Thermal cut-outs separately approved according to IEC 60730 with conditions indicated in a) & b)		N/A
	Thermal cut-outs tested as part of the equipment as indicated in c)		N/A
G.3.1.2	Test method and compliance		N/A
G.3.2	Thermal links	No such device	N/A
G.3.2.1	a) Thermal links tested separately according to IEC 60691 with specifics		N/A
	b) Thermal links tested as part of the equipment		N/A
G.3.2.2	Test method and compliance		N/A
G.3.3	PTC thermistors		N/A
G.3.4	Overcurrent protection devices	No such device	N/A
G.3.5	Safeguards components not mentioned in G.3.1 to G.3.4		N/A
G.3.5.1	Non-resettable devices suitably rated and marking provided		N/A
G.3.5.2	Single faults conditions..... :	(See appended table B.4)	N/A
G.4	Connectors		N/A
G.4.1	Spacings	No connector used	N/A
G.4.2	Mains connector configuration..... :		N/A
G.4.3	Plug is shaped that insertion into mains socket-outlets or appliance coupler is unlikely		N/A
G.5	Wound components		N/A
G.5.1	Wire insulation in wound components	No such components	N/A



IEC/EN 62368-1

Clause	Requirement + Test	Result - Remark	Verdict
G.5.1.2	Protection against mechanical stress		N/A
G.5.2	Endurance test	No such components	N/A
G.5.2.1	General test requirements		N/A
G.5.2.2	Heat run test		N/A
	Test time (days per cycle)		—
	Test temperature (°C)		—
G.5.2.3	Wound components supplied from the mains		N/A
G.5.2.4	No insulation breakdown		N/A
G.5.3	Transformers	No transformer used	N/A
G.5.3.1	Compliance method		N/A
	Position		N/A
	Method of protection		N/A
G.5.3.2	Insulation		N/A
	Protection from displacement of windings		—
G.5.3.3	Transformer overload tests		N/A
G.5.3.3.1	Test conditions		N/A
G.5.3.3.2	Winding temperatures		N/A
G.5.3.3.3	Winding temperatures - alternative test method		N/A
G.5.3.4	Transformers using FIW		N/A
G.5.3.4.1	General		N/A
	FIW wire nominal diameter		—
G.5.3.4.2	Transformers with basic insulation only		N/A
G.5.3.4.3	Transformers with double insulation or reinforced insulation		N/A
G.5.3.4.4	Transformers with FIW wound on metal or ferrite core		N/A
G.5.3.4.5	Thermal cycling test and compliance		N/A
G.5.3.4.6	Partial discharge test		N/A
G.5.3.4.7	Routine test		N/A
G.5.4	Motors	No motor used	N/A



IEC/EN 62368-1

Clause	Requirement + Test	Result - Remark	Verdict
G.5.4.1	General requirements		N/A
G.5.4.2	Motor overload test conditions		N/A
G.5.4.3	Running overload test		N/A
G.5.4.4.2	Locked-rotor overload test		N/A
	Test duration (days) :		—
G.5.4.5	Running overload test for DC motors		N/A
G.5.4.5.2	Tested in the unit		N/A
G.5.4.5.3	Alternative method		N/A
G.5.4.6	Locked-rotor overload test for DC motors		N/A
G.5.4.6.2	Tested in the unit		N/A
	Maximum Temperature :		N/A
G.5.4.6.3	Alternative method		N/A
G.5.4.7	Motors with capacitors		N/A
G.5.4.8	Three-phase motors		N/A
G.5.4.9	Series motors		N/A
	Operating voltage :		—
G.6	Wire Insulation		N/A
G.6.1	General	Only ES1 circuit existed in the EUT	N/A
G.6.2	Enamelled winding wire insulation	No such part	N/A
G.7	Mains supply cords		N/A
G.7.1	General requirements	Class III equipment, no such part	N/A
	Type..... :		—
G.7.2	Cross sectional area (mm ² or AWG)..... :		N/A
G.7.3	Cord anchorages and strain relief for non-detachable power supply cords		N/A
G.7.3.2	Cord strain relief		N/A
G.7.3.2.1	Requirements		N/A
	Strain relief test force (N)..... :		N/A
G.7.3.2.2	Strain relief mechanism failure		N/A



IEC/EN 62368-1			
Clause	Requirement + Test	Result - Remark	Verdict
G.7.3.2.3	Cord sheath or jacket position, distance (mm) ... :		N/A
G.7.3.2.4	Strain relief and cord anchorage material		N/A
G.7.4	Cord Entry		N/A
G.7.5	Non-detachable cord bend protection		N/A
G.7.5.1	Requirements		N/A
G.7.5.2	Test method and compliance		N/A
	Overall diameter or minor overall dimension, D (mm) :		—
	Radius of curvature after test (mm) :		—
G.7.6	Supply wiring space		N/A
G.7.6.1	General requirements		N/A
G.7.6.2	Stranded wire		N/A
G.7.6.2.1	Requirements		N/A
G.7.6.2.2	Test with 8 mm strand		N/A
G.8	Varistors		N/A
G.8.1	General requirements	No varistor used	N/A
G.8.2	Safeguards against fire		N/A
G.8.2.1	General		N/A
G.8.2.2	Varistor overload test		N/A
G.8.2.3	Temporary overvoltage test		N/A
G.9	Integrated circuit (IC) current limiters		N/A
G.9.1	Requirements	No such device used	N/A
	IC limiter output current (max. 5A)..... :		—
	Manufacturers' defined drift :		—
G.9.2	Test Program		N/A
G.9.3	Compliance		N/A
G.10	Resistors		N/A
G.10.1	General	No such resistor used	N/A
G.10.2	Conditioning	No such resistor used	N/A
G.10.3	Resistor test	No such resistor used	N/A



IEC/EN 62368-1			
Clause	Requirement + Test	Result - Remark	Verdict
G.10.4	Voltage surge test	No such resistor used	N/A
G.10.5	Impulse test	No such resistor used	N/A
G.10.6	Overload test	No such resistor used	N/A
G.11	Capacitors and RC units		N/A
G.11.1	General requirements	No such capacitor used	N/A
G.11.2	Conditioning of capacitors and RC units	No such capacitor used	N/A
G.11.3	Rules for selecting capacitors	No such capacitor used	N/A
G.12	Optocouplers		N/A
	Optocouplers comply with IEC 60747-5-5 with specifics	No such optocoupler used	N/A
	Type test voltage Vini,a		—
	Routine test voltage, Vini, b.....		—
G.13	Printed boards		N/A
		Class III equipment and all electrical circuits of EUT are ES1, only the functional insulation inside the EUT	
G.13.1	General requirements		N/A
G.13.2	Uncoated printed boards		N/A
G.13.3	Coated printed boards		N/A
G.13.4	Insulation between conductors on the same inner surface		N/A
G.13.5	Insulation between conductors on different surfaces		N/A
	Distance through insulation		N/A
	Number of insulation layers (pcs)		—
G.13.6	Tests on coated printed boards		N/A
G.13.6.1	Sample preparation and preliminary inspection		N/A
G.13.6.2	Test method and compliance		N/A
G.14	Coating on components terminals		N/A
G.14.1	Requirements	No such coating used	N/A
G.15	Pressurized liquid filled components		N/A
G.15.1	Requirements	No such component used	N/A



IEC/EN 62368-1			
Clause	Requirement + Test	Result - Remark	Verdict
G.15.2	Test methods and compliance	No such component used	N/A
G.15.2.1	Hydrostatic pressure test		N/A
G.15.2.2	Creep resistance test		N/A
G.15.2.3	Tubing and fittings compatibility test		N/A
G.15.2.4	Vibration test		N/A
G.15.2.5	Thermal cycling test		N/A
G.15.2.6	Force test		N/A
G.15.3	Compliance	No such component used	N/A
G.16	IC including capacitor discharge function (ICX)		N/A
G.16.1	Condition for fault tested is not required	No such component used	N/A
	ICX with associated circuitry tested in equipment		N/A
	ICX tested separately		N/A
G.16.2	Tests	No such component used	N/A
	Smallest capacitance and smallest resistance specified by ICX manufacturer for impulse test.. :		—
	Mains voltage that impulses to be superimposed on..... :		—
	Largest capacitance and smallest resistance for ICX tested by itself for 10000 cycles test :		—
G.16.3	Capacitor discharge test..... :	No such component used	N/A
H	CRITERIA FOR TELEPHONE RINGING SIGNALS		N/A
H.1	General		N/A
H.2	Method A		N/A
H.3	Method B		N/A
H.3.1	Ringling signal	No such ringing signal	N/A
H.3.1.1	Frequency (Hz) :	No such ringing signal	—
H.3.1.2	Voltage (V) :	No such ringing signal	—
H.3.1.3	Cadence; time (s) and voltage (V) :	No such ringing signal	—
H.3.1.4	Single fault current (mA):..... :	No such ringing signal	—
H.3.2	Tripping device and monitoring voltage	No such ringing signal	N/A



IEC/EN 62368-1			
Clause	Requirement + Test	Result - Remark	Verdict
H.3.2.1	Conditions for use of a tripping device or a monitoring voltage	No such ringing signal	N/A
H.3.2.2	Tripping device	No such ringing signal	N/A
H.3.2.3	Monitoring voltage (V) :	No such ringing signal	N/A
J	INSULATED WINDING WIRES FOR USE WITHOUT INTERLEAVED INSULATION		N/A
J.1	General		N/A
	Winding wire insulation..... :	No such part	—
	Solid round winding wire, diameter (mm) :		N/A
	Solid square and rectangular (flatwise bending) winding wire, cross-sectional area (mm ²) :		N/A
J.2/J.3	Tests and Manufacturing		—
K	SAFETY INTERLOCKS		N/A
K.1	General requirements		N/A
	Instructional safeguard :	No such device	N/A
K.2	Components of safety interlock safeguard mechanism		N/A
K.3	Inadvertent change of operating mode		N/A
K.4	Interlock safeguard override		N/A
K.5	Fail-safe		N/A
K.5.1	Under single fault condition		N/A
K.6	Mechanically operated safety interlocks		N/A
K.6.1	Endurance requirement		N/A
K.6.2	Test method and compliance :		N/A
K.7	Interlock circuit isolation		N/A
K.7.1	Separation distance for contact gaps & interlock circuit elements		N/A
	In circuit connected to mains, separation distance for contact gaps (mm)..... :		N/A
	In circuit isolated from mains, separation distance for contact gaps (mm)..... :		N/A
	Electric strength test before and after the test of K.7.2 :	(See appended table 5.4.9)	N/A
K.7.2	Overload test, Current (A) :		N/A



IEC/EN 62368-1			
Clause	Requirement + Test	Result - Remark	Verdict
K.7.3	Endurance test		N/A
K.7.4	Electric strength test		N/A
L	DISCONNECT DEVICES		N/A
L.1	General requirements	The EUT is not directly connected to mains	N/A
L.2	Permanently connected equipment	The EUT is not directly connected to mains	N/A
L.3	Parts that remain energized	The EUT is not directly connected to mains	N/A
L.4	Single-phase equipment	The EUT is not directly connected to mains	N/A
L.5	Three-phase equipment	The EUT is not directly connected to mains	N/A
L.6	Switches as disconnect devices	No such device	N/A
L.7	Plugs as disconnect devices	The EUT is not directly connected to mains	N/A
L.8	Multiple power sources	The EUT is not directly connected to mains	N/A
	Instructional safeguard	The EUT is not directly connected to mains	N/A
M	EQUIPMENT CONTAINING BATTERIES AND THEIR PROTECTION CIRCUITS		N/A
M.1	General requirements		N/A
M.2	Safety of batteries and their cells		N/A
M.2.1	Batteries and their cells comply with relevant IEC standards		N/A
M.3	Protection circuits for batteries provided within the equipment		N/A
M.3.1	Requirements		N/A
M.3.2	Test method	See below	N/A
	Overcharging of a rechargeable battery	No such battery used	N/A
	Excessive discharging		N/A
	Unintentional charging of a non-rechargeable battery		N/A
	Reverse charging of a rechargeable battery		N/A



IEC/EN 62368-1			
Clause	Requirement + Test	Result - Remark	Verdict
M.3.3	Compliance		N/A
M.4	Additional safeguards for equipment containing a portable secondary lithium battery		N/A
M.4.1	General	No such battery used	N/A
M.4.2	Charging safeguards	No such battery used	N/A
M.4.2.1	Requirements	No such battery used	N/A
M.4.2.2	Compliance	No such battery used	N/A
M.4.3	Fire enclosure	No such battery used	N/A
M.4.4	Drop test of equipment containing a secondary lithium battery	No such battery used	N/A
M.4.4.2	Preparation and procedure for the drop test	No such battery used	N/A
M.4.4.3	Drop, Voltage on reference and dropped batteries (V); voltage difference during 24 h period (%): ..	No such battery used	N/A
M.4.4.4	Check of the charge/discharge function	No such battery used	N/A
M.4.4.5	Charge / discharge cycle test	No such battery used	N/A
M.4.4.6	Compliance	No such battery used	N/A
M.5	Risk of burn due to short-circuit during carrying		N/A
M.5.1	Requirement		N/A
M.5.2	Test method and compliance		N/A
M.6	Safeguards against short-circuits		N/A
M.6.1	External and internal faults		N/A
M.6.2	Compliance		N/A
M.7	Risk of explosion from lead acid and NiCd batteries		N/A
M.7.1	Ventilation preventing explosive gas concentration		N/A
	Calculated hydrogen generation rate		N/A
M.7.2	Test method and compliance		N/A
	Minimum air flow rate, Q (m3/h)		N/A
M.7.3	Ventilation tests		N/A
M.7.3.1	General		N/A
M.7.3.2	Ventilation test – alternative 1		N/A
	Hydrogen gas concentration (%)		N/A



IEC/EN 62368-1			
Clause	Requirement + Test	Result - Remark	Verdict
M.7.3.3	Ventilation test – alternative 2		N/A
	Obtained hydrogen generation rate..... :		N/A
M.7.3.4	Ventilation test – alternative 3		N/A
	Hydrogen gas concentration (%)..... :		N/A
M.7.4	Marking..... :		N/A
M.8	Protection against internal ignition from external spark sources of batteries with aqueous electrolyte		N/A
M.8.1	General		N/A
M.8.2	Test method		N/A
M.8.2.1	General		N/A
M.8.2.2	Estimation of hypothetical volume VZ (m3/s)..... :		—
M.8.2.3	Correction factors..... :		—
M.8.2.4	Calculation of distance d (mm)..... :		—
M.9	Preventing electrolyte spillage		N/A
M.9.1	Protection from electrolyte spillage		N/A
M.9.2	Tray for preventing electrolyte spillage		N/A
M.10	Instructions to prevent reasonably foreseeable misuse		N/A
	Instructional safeguard..... :		N/A
N	ELECTROCHEMICAL POTENTIALS		N/A
	Material(s) used..... :	Not such equipment.	—
O	MEASUREMENT OF CREEPAGE DISTANCES AND CLEARANCES		N/A
	Value of X (mm)..... :	Class III equipment.	—
P	SAFEGUARDS AGAINST CONDUCTIVE OBJECTS		N/A
P.1	General	No ES3, PS3 circuit	N/A
P.2	Safeguards against entry or consequences of entry of a foreign object		N/A
P.2.1	General		N/A
P.2.2	Safeguards against entry of a foreign object		N/A
	Location and Dimensions (mm)..... :		—
P.2.3	Safeguards against the consequences of entry of a foreign object		N/A



IEC/EN 62368-1			
Clause	Requirement + Test	Result - Remark	Verdict
P.2.3.1	Safeguard requirements		N/A
	The ES3 and PS3 keep-out volume in Figure P.3 not applicable to transportable equipment		N/A
	Transportable equipment with metalized plastic parts..... :		N/A
P.2.3.2	Consequence of entry test..... :		N/A
P.3	Safeguards against spillage of internal liquids		N/A
P.3.1	General		N/A
P.3.2	Determination of spillage consequences		N/A
P.3.3	Spillage safeguards		N/A
P.3.4	Compliance		N/A
P.4	Metallized coatings and adhesives securing parts		N/A
P.4.1	General		N/A
P.4.2	Tests		N/A
	Conditioning, TC (°C) :		—
	Duration (weeks)..... :		—
Q	CIRCUITS INTENDED FOR INTERCONNECTION WITH BUILDING WIRING		N/A
Q.1	Limited power sources		N/A
Q.1.1	Requirements		N/A
	a) Inherently limited output		N/A
	b) Impedance limited output		N/A
	c) Regulating network limited output		N/A
	d) Overcurrent protective device limited output		N/A
	e) IC current limiter complying with G.9		N/A
Q.1.2	Test method and compliance :		N/A
	Current rating of overcurrent protective device (A) :		N/A
Q.2	Test for external circuits – paired conductor cable		N/A
	Maximum output current (A) :		N/A
	Current limiting method :		—



IEC/EN 62368-1

Clause	Requirement + Test	Result - Remark	Verdict
R	LIMITED SHORT CIRCUIT TEST		N/A
R.1	General		N/A
R.2	Test setup		N/A
	Overcurrent protective device for test..... :		—
R.3	Test method		N/A
	Cord/cable used for test :		—
R.4	Compliance		N/A
S	TESTS FOR RESISTANCE TO HEAT AND FIRE		N/A
S.1	Flammability test for fire enclosures and fire barrier materials of equipment where the steady state power does not exceed 4 000 W		N/A
	Samples, material :		—
	Wall thickness (mm) :		—
	Conditioning (°C) :		—
	Test flame according to IEC 60695-11-5 with conditions as set out		N/A
	- Material not consumed completely		N/A
	- Material extinguishes within 30s		N/A
	- No burning of layer or wrapping tissue		N/A
S.2	Flammability test for fire enclosure and fire barrier integrity		N/A
	Samples, material..... :		—
	Wall thickness (mm) :		—
	Conditioning (°C) :		—
S.3	Flammability test for the bottom of a fire enclosure		N/A
S.3.1	Mounting of samples		N/A
S.3.2	Test method and compliance		N/A
	Mounting of samples :		—
	Wall thickness (mm) :		—
S.4	Flammability classification of materials		N/A
S.5	Flammability test for fire enclosures and fire barrier materials of equipment where the steady state power exceeding 4 000 W		N/A



IEC/EN 62368-1			
Clause	Requirement + Test	Result - Remark	Verdict
	Samples, material		—
	Wall thickness (mm)		—
	Conditioning (°C)		—
T	MECHANICAL STRENGTH TESTS		N/A
T.1	General		N/A
T.2	Steady force test, 10 N	Evaluated in the end product	N/A
T.3	Steady force test, 30 N		N/A
T.4	Steady force test, 100 N		N/A
T.5	Steady force test, 250 N		N/A
T.6	Enclosure impact test		N/A
	Fall test		N/A
	Swing test		N/A
T.7	Drop test		N/A
T.8	Stress relief test.....		N/A
T.9	Glass Impact Test		N/A
T.10	Glass fragmentation test		N/A
	Number of particles counted.....	No such part	N/A
T.11	Test for telescoping or rod antennas		N/A
	Torque value (Nm)	No such part	--
U	MECHANICAL STRENGTH OF CATHODE RAY TUBES (CRT) AND PROTECTION AGAINST THE EFFECTS OF IMPLOSION		N/A
U.1	General		N/A
	Instructional safeguard :	No cathode ray tube used	N/A
U.2	Test method and compliance for non-intrinsically protected CRTs		N/A
U.3	Protective screen		N/A
V	DETERMINATION OF ACCESSIBLE PARTS		N/A
V.1	Accessible parts of equipment		N/A
V.1.1	General	Evaluated in the end product	N/A
V.1.2	Surfaces and openings tested with jointed test probes	Evaluated in the end product	N/A



IEC/EN 62368-1			
Clause	Requirement + Test	Result - Remark	Verdict
V.1.3	Openings tested with straight unjointed test probes		N/A
V.1.4	Plugs, jacks, connectors tested with blunt probe		N/A
V.1.5	Slot openings tested with wedge probe		N/A
V.1.6	Terminals tested with rigid test wire		N/A
V.2	Accessible part criterion		N/A
X	ALTERNATIVE METHOD FOR DETERMINING CLEARANCES FOR INSULATION IN CIRCUITS CONNECTED TO AN AC MAINS NOT EXCEEDING 420 V PEAK (300 V RMS)		N/A
	Clearance : (See appended table X)		N/A
Y	CONSTRUCTION REQUIREMENTS FOR OUTDOOR ENCLOSURES		N/A
Y.1	General	Not such equipment	N/A
Y.2	Resistance to UV radiation		N/A
Y.3	Resistance to corrosion		N/A
Y.3	Resistance to corrosion		N/A
Y.3.1	Metallic parts of outdoor enclosures are resistant to effects of water-borne contaminants by :		N/A
Y.3.2	Test apparatus		N/A
Y.3.3	Water – saturated sulphur dioxide atmosphere		N/A
Y.3.4	Test procedure..... :		N/A
Y.3.5	Compliance		N/A
Y.4	Gaskets	No gasket used	N/A
Y.4.1	General		N/A
Y.4.2	Gasket tests		N/A
Y.4.3	Tensile strength and elongation tests		N/A
	Alternative test methods :		N/A
Y.4.4	Compression test		N/A
Y.4.5	Oil resistance		N/A
Y.4.6	Securing means	(See Annex P.4)	N/A
Y.5	Protection of equipment within an outdoor enclosure		N/A
Y.5.1	General	Not such equipment	N/A
Y.5.2	Protection from moisture		N/A



**BUREAU
VERITAS**

Test Report No.: RD2312WDG0147

IEC/EN 62368-1

Clause	Requirement + Test	Result - Remark	Verdict
	Relevant tests of IEC 60529 or Y.5.3 :		N/A
Y.5.3	Water spray test		N/A
Y.5.4	Protection from plants and vermin		N/A
Y.5.5	Protection from excessive dust		N/A
Y.5.5.1	General		N/A
Y.5.5.2	IP5X equipment		N/A
Y.5.5.3	IP6X equipment		N/A
Y.6	Mechanical strength of enclosures	Not such equipment	N/A
Y.6.1	General		N/A
Y.6.2	Impact test :		N/A



IEC 62368_1E ATTACHMENT

Clause	Requirement + Test	Result - Remark	Verdict
--------	--------------------	-----------------	---------

5.2	TABLE: Classification of electrical energy sources						P
Supply Voltage	Location (e.g. circuit designation)	Test conditions	Parameters				ES Class
			U (V)	I (mA)	Type ¹⁾	Additional Info ²⁾	
Max. 3.8Vdc	EUT Input	Normal	Max. 3.8Vdc	--	--	--	ES1 (Definition)

Supplementary information:
 1) Type: Steady state (SS), Capacitance (CP), Single pulse (SP), Repetitive pulses (RP), etc.
 2) Additional Info: Frequency, Pulse duration, Pulse off time, Capacitance value, etc.

5.4.1.8	TABLE: Working voltage measurement					N/A
Location	RMS voltage (V)	Peak voltage (V)	Frequency (Hz)	Comments		
--	--	--	--	--		

Supplementary information:

5.4.1.10.2	TABLE: Vicat softening temperature of thermoplastics				N/A
Method			ISO 306 / B50		—
Object/ Part No./Material	Manufacturer/trademark	Thickness (mm)	T softening (°C)		
--	--	--	--		

Supplementary information:

5.4.1.10.3	TABLE: Ball pressure test of thermoplastics				N/A
Allowed impression diameter (mm)			≤ 2 mm		—
Object/Part No./Material	Manufacturer/trademark	Thickness (mm)	Test temperature (°C)	Impression diameter (mm)	
--	--	--	--	--	

Supplementary information:

5.4.2, 5.4.3	TABLE: Minimum Clearances/Creepage distance								N/A
Clearance (cl) and creepage distance (cr) at/of/between:	U _p (V)	U _{rms} (V)	Freq ¹⁾ (Hz)	Required cl (mm)	cl (mm)	E.S. ²⁾ (V)	Required cr (mm)	cr (mm)	



IEC 62368_1E ATTACHMENT

Clause	Requirement + Test	Result - Remark	Verdict
--------	--------------------	-----------------	---------

--	--	--	--
----	----	----	----

Supplementary information:

- 1) Only for frequency above 30 kHz
- 2) Complete Electric Strength voltage (E.S. (V) when 5.4.2.4 applied)

5.4.4.2	TABLE: Minimum distance through insulation				N/A
----------------	---	--	--	--	-----

Distance through insulation (DTI) at/of	Peak voltage (V)	Insulation	Required DTI (mm)	Measured DTI (mm)
--	--	--	--	--

Supplementary information:--

5.4.4.9	TABLE: Solid insulation at frequencies >30 kHz					N/A
----------------	--	--	--	--	--	-----

Insulation material	E_p	Frequency (kHz)	K_R	Thickness d (mm)	Insulation	V_{PW} (Vpk)
--	--	--	--	--	--	--

Supplementary information:

5.4.9	TABLE: Electric strength tests			N/A
--------------	---------------------------------------	--	--	-----

Test voltage applied between:	Voltage shape (Surge, Impulse, AC, DC, etc.)	Test voltage (V)	Breakdown Yes / No
--	--	--	--

Supplementary information:

5.5.2.2	TABLE: Stored discharge on capacitors				N/A
----------------	--	--	--	--	-----

Location	Supply voltage (V)	Operating and fault condition ¹⁾	Switch position	Measured voltage (Vpk)	ES Class
--	--	--	--	--	--

Supplementary information:

X-capacitors installed for testing:

bleeding resistor rating:

ICX:

1) Normal operating condition (e.g., normal operation, or open fuse), SC= short circuit, OC= open circuit



IEC 62368_1E ATTACHMENT

Clause	Requirement + Test	Result - Remark	Verdict
--------	--------------------	-----------------	---------

5.6.6	TABLE: Resistance of protective conductors and terminations				N/A
Location	Test current (A)	Duration (min)	Voltage drop (V)	Resistance (Ω)	
--	--	--	--	--	
Supplementary information:					

5.7.4	TABLE: Unearthed accessible parts					N/A
Location	Operating and fault conditions	Supply Voltage (V)	Parameters			ES class
			Voltage (V _{rms} OR V _{pk})	Current (A _{rms} OR A _{pk})	Freq. (Hz)	
--	--	--	--	--	--	--
Supplementary information:						
Abbreviation: SC= short circuit; OC= open circuit						

5.7.5	TABLE: Earthed accessible conductive part				N/A
Supply voltage (V)					—
Phase(s)	<input type="checkbox"/> Single Phase; <input type="checkbox"/> Three Phase: <input type="checkbox"/> Delta <input type="checkbox"/> Wye				
Power Distribution System	<input type="checkbox"/> TN <input type="checkbox"/> TT <input type="checkbox"/> IT				
Location	Fault Condition No in IEC 60990 clause 6.2.2	Touch current (mA)	Comment		
--	--	--	--		
Supplementary Information:					

5.8	TABLE: Backfeed safeguard in battery backed up supplies					N/A
Location	Supply voltage (V)	Operating and fault condition	Time (s)	Open-circuit voltage (V)	Touch current (A)	ES Class
--	--	--	--	--	--	--
Supplementary information:						
Abbreviation: SC= short circuit, OC= open circuit						

6.2.2	TABLE: Power source circuit classifications					P
Location	Operating and fault condition	Voltage (V)	Current (A)	Max. Power ¹ (W)	Time (S)	PS class



IEC 62368_1E ATTACHMENT

Clause	Requirement + Test	Result - Remark				Verdict
--------	--------------------	-----------------	--	--	--	---------

All parts within equipment	Normal	--	--	--	--	PS2 (manufacturer declares)
----------------------------	--------	----	----	----	----	--------------------------------

Supplementary information:
 Abbreviation: SC= short circuit; OC= open circuit
 1) Measured after 3 s for PS1 and measured after 5 s for PS2 and PS3.

6.2.3.1 **TABLE: Determination of Arcing PIS** **N/A**

Location	Open circuit voltage after 3 s (Vpk)	Measured r.m.s current (A)	Calculated value	Arcing PIS? Yes / No
See below	--	--	--	--

Supplementary information:

6.2.3.2 **TABLE: Determination of resistive PIS** **P**

Location	Operating and fault condition	Dissipate power (W)	Arcing PIS? Yes / No
All parts within equipment	--	--	Yes (manufacturer declares)

Supplementary information:
 Abbreviation: SC= short circuit; OC= open circuit

8.5.5 **TABLE: High pressure lamp** **N/A**

Lamp manufacturer	Lamp type	Explosion method	Longest axis of glass particle (mm)	Particle found beyond 1 m Yes / No
--	--	--	--	--

Supplementary information:



IEC 62368_1E ATTACHMENT

Clause	Requirement + Test	Result - Remark	Verdict
--------	--------------------	-----------------	---------

9.6	TABLE: Temperature measurements for wireless power transmitters							N/A
Supply voltage (V)							—	
Max. transmit power of transmitter (W)							—	
Foreign objects	w/o receiver and direct contact		with receiver and direct contact		with receiver and at distance of 2 mm		with receiver and at distance of 5 mm	
	Object (°C)	Ambient (°C)	Object (°C)	Ambient (°C)	Object (°C)	Ambient (°C)	Object (°C)	Ambient (°C)
--	--	--	--	--	--	--	--	--
Supplementary information:								

5.4.1.4, 9.3, B.1.5, B.2.6	TABLE: Temperature measurements							P
Supply voltage (V)		3.8Vdc & 3.3Vdc			--	--	—	
Ambient temperature during test T_{amb} (°C)		21.6	--	--	--	—		
Maximum measured temperature T of part/at:		T (°C)					Allowed T_{max} (°C)	
Calculated value for T_{ma} :		--	60.0	--	--	--		
PCB near U2		28.3	66.7	--	--	125		
PCB near U7		28.8	67.2	--	--	125		
PCB near U9		28.0	66.4	--	--	125		
PCB near U3		27.9	66.3	--	--	125		
Metal heat sink outside near U1		28.5	31.9	--	--	60		
Ambient		--	Shift to 25	--	--	--		
Temperature T of winding:	t_1 (°C)	R_1 (Ω)	t_2 (°C)	R_2 (Ω)	T (°C)	Allowed T_{max} (°C)	Insulation class	
--	--	--	--	--	--	--	--	
Supplementary information:								
Note 1: T_{ma} should be considered as directed by applicable requirement								
Note 2: T_{ma} is not included in assessment of Touch Temperatures (Clause 9)								

B.2.5	TABLE: Input test	N/A
-------	-------------------	-----



IEC 62368_1E ATTACHMENT

Clause	Requirement + Test	Result - Remark	Verdict
--------	--------------------	-----------------	---------

U (V)	Hz	I (mA)	I rated (mA)	P (W)	P rated (W)	Fuse No	I fuse (A)	Condition/status
--	--	--	--	--	--	--	--	--

Supplementary information:

Equipment may be have rated current or rated power or both. Both should be measured.

B.3, B.4	TABLE: Abnormal operating and fault condition tests	P
-----------------	--	----------

Ambient temperature T _{amb} (°C).....:	25.0	—
---	------	---

Power source for EUT: Manufacturer, model/type, outputrating....:	--	—
---	----	---

Component No.	Condition	Supply voltage (V)	Test time	Fuse no.	Fuse current (A)	Observation
U5 Pin1-8	SC	3.3Vdc & 3.8Vdc	30min	--	--	The unit operated as normal. After testing, no damage, no hazards.
C41	SC	3.3Vdc & 3.8Vdc	30min	--	--	The unit shutdown immediately. After testing, no damage, no hazards.

Supplementary information:

M.3	TABLE: Protection circuits for batteries provided within the equipment	N/A
------------	---	------------

Is it possible to install the battery in a reverse polarity position?	--	—
---	----	---

Equipment Specification	Charging			
	Voltage (V)		Current (A)	
	--		--	

Manufacturer/type	Battery specification					
	Non-rechargeable batteries		Rechargeable batteries			
	Discharging current (A)	Unintentional charging current (A)	Charging		Discharging current (A)	Reverse charging current (A)
			Voltage (V)	Current (A)		



IEC 62368_1E ATTACHMENT

Clause	Requirement + Test	Result - Remark	Verdict
--------	--------------------	-----------------	---------

Max. current during normal condition	--	--	--	--	--	--
Max. current during fault condition	--	--	--	--	--	--

Note: The tests of M.3.2 are applicable only when above appropriate data is not available.

Specified battery temperature (°C)	--	--
--	----	----

Component No.	Fault condition	Charge/discharge mode	Test time	Temp. (°C)	Current (A)	Voltage (V)	Observation
--	--	--	--	--	--	--	--

Supplementary information:

Abbreviation: SC= short circuit; OC= open circuit NL= no chemical leakage; NS= no spillage of liquid; NE= no explosion; NF= no emission of flame or expulsion of molten metal.

M.4.2	TABLE: Charging safeguards for equipment containing a secondary lithium battery	N/A
--------------	--	------------

Maximum specified charging voltage (V)	--	---
Maximum specified charging current (A)	--	---
Highest specified charging temperature (°C)	--	---
Lowest specified charging temperature (°C)	--	---

Battery manufacturer/type	Operating and fault condition	Measurement			Observation
		Charging voltage (V)	Charging current (A)	Temp. (°C)	
--	--	--	--	--	--

Supplementary information:

Abbreviation: SC= short circuit; OC= open circuit; MSCV= maximum specified charging voltage; MSCC= maximum specified charging current; HSCT= highest specified charging temperature; LSCT= lowest specified charging temperature

Q.1	TABLE: Circuits intended for interconnection with building wiring (LPS)						N/A
------------	--	--	--	--	--	--	------------

Output Circuit	Condition	U _{oc} (V)	Time (s)	I _{sc} (A)		S (VA)	
				Meas.	Limit	Meas.	Limit
--	--	--	--	--	--	--	--
--	--	--	--	--	--	--	--

Supplementary Information:



IEC 62368_1E ATTACHMENT

Clause	Requirement + Test	Result - Remark	Verdict
--------	--------------------	-----------------	---------

T.2, T.3, T.4, T.5	TABLE: Steady force test					N/A
Part/Location	Material	Thickness (mm)	Probe	Force (N)	Test Duration (s)	Observation
--	--	--	--	--	--	--
Supplementary information:						

T.6, T.9	TABLE: Impact test				N/A
Location/part	Material	Thickness (mm)	Height (mm)	Observation	
--	--	--	--	--	
Supplementary information:					

T.7	TABLE: Drop test				N/A
Location/part	Material	Thickness (mm)	Height (mm)	Observation	
--	--	--	--	--	
Supplementary information:					

T.8	TABLE: Stress relief test					N/A
Location/Part	Material	Thickness (mm)	Oven Temperature (°C)	Duration (h)	Observation	
--	--	--	--	--	--	
Supplementary information:						

X	TABLE: Alternative method for determining minimum clearances distances			N/A
Clearance distanced between:	Peak of working voltage (V)	Required cl (mm)	Measured cl (mm)	
--	--	--	--	
Supplementary information:				

4.1.2	TABLE: Critical components information	P
--------------	---	---



**BUREAU
VERITAS**

Test Report No.: RD2312WDG0147

IEC 62368_1E ATTACHMENT

Clause	Requirement + Test	Result - Remark	Verdict
--------	--------------------	-----------------	---------

Object / part No.	Manufacturer/ trademark	Type / model	Technical data	Standard	Mark(s) of conformity ¹⁾
PCB material	APCB INC	88A	V-0, 125°C	UL 796	UL
Or	Interchangeable	--	V-1 or better, min. 125°C	UL796 or UL 94	UL

-Description²⁾: Interchangeability based on specified rating

Supplementary information:

¹⁾ Provided evidence ensures the agreed level of compliance. See OD-CB2039.

²⁾ Description line content is optional. Main line description needs to clearly detail the component used for testing



IEC 62368_1E ATTACHMENT			
Clause	Requirement + Test	Result - Remark	Verdict

ATTACHMENT TO TEST REPORT
IEC 62368-1
EUROPEAN GROUP DIFFERENCES AND NATIONAL DIFFERENCES
 (AUDIO/VIDEO, INFORMATION AND COMMUNICATION TECHNOLOGY EQUIPMENT –
 PART 1: SAFETY REQUIREMENTS)

Differences according to.....: EN IEC 62368-1:2020+A11:2020
Attachment Form No.: EU_GD_IEC62368_1E
Attachment Originator: UL(Demko)
Master Attachment: 2021-02-04

Copyright © 2021 IEC System for Conformity Testing and Certification of Electrical Equipment (IECEE), Geneva, Switzerland. All rights reserved.

	CENELEC COMMON MODIFICATIONS (EN)	--
	Clause numbers in the cells that are shaded light grey are clause references in EN IEC 62368-1:2020+A11:2020. All other clause numbers in that column, except for those in the paragraph below, refers to IEC 62368-1:2018. Clauses, subclauses, notes, tables, figures and annexes which are additional to those in IEC 62368-1:2018 are prefixed "Z".	P
	Add the following annexes: Annex ZA (normative) Normative references to international publications with their corresponding European publications Annex ZB (normative) Special national conditions Annex ZC (informative) A-deviations Annex ZD (informative) IEC and CENELEC code designations for flexible cords	P
1	Modification to Clause 3.	--
3.3.19	Sound exposure <i>Replace 3.3.19 of IEC 62368-1 with the following definitions:</i>	N/A
3.3.19.1	momentary exposure level, MEL metric for estimating 1 s sound exposure level from the HD 483-1 S2 test signal applied to both channels, based on EN 50332-1:2013, 4.2. Note 1 to entry: MEL is measured as A-weighted levels in dB. Note 2 to entry: See B.3 of EN 50332-3:2017 for additional information.	N/A
3.3.19.3	sound exposure, E	N/A



IEC 62368_1E ATTACHMENT			
Clause	Requirement + Test	Result - Remark	Verdict
	<p>A-weighted sound pressure (p) squared and integrated over a stated period of time, T</p> <p>Note 1 to entry: The SI unit is Pa² s.</p> $E = \int_0^T p(t)^2 dt$		
3.3.19.4	<p>sound exposure level, SEL</p> <p>logarithmic measure of sound exposure relative to a reference value, E_0, typically the 1 kHz threshold of hearing in humans.</p> <p>Note 1 to entry: <i>SEL</i> is measured as A-weighted levels in dB.</p> $SEL = 10 \lg \left(\frac{E}{E_0} \right) \text{ dB}$ <p>Note 2 to entry: See B.4 of EN 50332-3:2017 for additional information.</p>		N/A
3.3.19.5	<p>digital signal level relative to full scale, dBFS</p> <p>levels reported in dBFS are always r.m.s. Full scale level, 0 dBFS, is the level of a dc-free 997-Hz sine wave whose undithered positive peak value is positive digital full scale, leaving the code corresponding to negative digital full scale unused</p> <p>Note 1 to entry: It is invalid to use dBFS for non-r.m.s. levels. Because the definition of full scale is based on a sine wave, the level of signals with a crest factor lower than that of a sine wave may exceed 0 dBFS. In particular, square wave signals may reach +3,01 dBFS.</p>		N/A
2	Modification to Clause 10		--
10.6	<p>Safeguards against acoustic energy sources</p> <p>Replace 10.6 of IEC 62368-1 with the following:</p>		N/A
10.6.1.1	<p>Introduction</p> <p>Safeguard requirements for protection against long-term exposure to excessive sound pressure levels from personal music players closely coupled to the ear are specified below.</p> <p>Requirements for earphones and headphones intended for use</p>		N/A



IEC 62368_1E ATTACHMENT

Clause	Requirement + Test	Result - Remark	Verdict
	<p>with personal music players are also covered. A personal music player is a portable equipment intended for use by an ordinary person, that:</p> <ul style="list-style-type: none"> – is designed to allow the user to listen to audio or audiovisual content / material; and – uses a listening device, such as headphones or earphones that can be worn in or on or around the ears; and – has a player that can be body worn (of a size suitable to be carried in a clothing pocket) and is intended for the user to walk around with while in continuous use (for example, on a street, in a subway, at an airport, etc.). <p>EXAMPLES Portable CD players, MP3 audio players, mobile phones with MP3 type features, PDAs or similar equipment.</p> <p>Personal music players shall comply with the requirements of either 10.6.2 or 10.6.3.</p> <p>NOTE 1 Protection against acoustic energy sources from telecom applications is referenced to ITU-T P.360.</p> <p>NOTE 2 It is the intention of the Committee to allow the alternative methods for now, but to only use the dose measurement method as given in 10.6.5 in future. Therefore, manufacturers are encouraged to implement 10.6.5 as soon as possible.</p> <p>Listening devices sold separately shall comply with the requirements of 10.6.6. These requirements are valid for music or video mode only. The requirements do not apply to:</p> <ul style="list-style-type: none"> – professional equipment; <p>NOTE 3 Professional equipment is equipment sold through special sales channels. All products sold through normal electronics stores are considered not to be professional equipment.</p> <ul style="list-style-type: none"> – hearing aid equipment and other devices for assistive listening; – the following type of analogue personal music players: <ul style="list-style-type: none"> • long distance radio receiver (for example, a multiband radio receiver or world band radio 		



IEC 62368_1E ATTACHMENT

Clause	Requirement + Test	Result - Remark	Verdict
	<p>receiver, an AM radio receiver), and</p> <ul style="list-style-type: none"> • cassette player/recorder; <p>NOTE 4 This exemption has been allowed because this technology is falling out of use and it is expected that within a few years it will no longer exist. This exemption will not be extended to other technologies.</p> <p>– a player while connected to an external amplifier that does not allow the user to walk around while in use.</p> <p>For equipment that is clearly designed or intended primarily for use by children, the limits of the relevant toy standards may apply.</p> <p>The relevant requirements are given in EN 71-1:2011, 4.20 and the related tests methods and measurement distances apply.</p>		
10.6.1.2	<p>Non-ionizing radiation from radio frequencies in the range 0 to 300 GHz</p> <p>The amount of non-ionizing radiation is regulated by European Council Recommendation 1999/519/EC of 12 July 1999 on the limitation of exposure of the general public to electromagnetic fields (0 Hz to 300 GHz). For intentional radiators, ICNIRP guidelines should be taken into account for Limiting Exposure to Time-Varying Electric, Magnetic, and Electromagnetic Fields (up to 300 GHz). For hand-held and body mounted devices, attention is drawn to EN 50360 and EN 50566.</p>		N/A
10.6.2	<p>Classification of devices without the capacity to estimate sound dose</p>		N/A
10.6.2.1	<p>General</p> <p>This standard is transitioning from short-term based (30 s) requirements to long-term based (40 hour) requirements. These clauses remain in effect only for devices that do not comply with sound dose estimation as stipulated in EN 50332-3.</p> <p>For classifying the acoustic output $L_{Aeq,T}$, measurements are based on the A-weighted equivalent sound pressure level over a 30 s</p>		N/A



IEC 62368_1E ATTACHMENT

Clause	Requirement + Test	Result - Remark	Verdict
	<p>period.</p> <p>For music where the average sound pressure (long term $L_{Aeq, T}$) measured over the duration of the song is lower than the average produced by the programme simulation noise, measurements may be done over the duration of the complete song. In this case, T becomes the duration of the song.</p> <p>NOTE Classical music, acoustic music and broadcast typically has an average sound pressure (long term $L_{Aeq, T}$) which is much lower than the average programme simulation noise. Therefore, if the player is capable to analyse the content and compare it with the programme simulation noise, the warning does not need to be given as long as the average sound pressure of the song does not exceed the required limit. For example, if the player is set with the programme simulation noise to 85 dB, but the average music level of the song is only 65 dB, there is no need to give a warning or ask an acknowledgement as long as the average sound level of the song is not above the basic limit of 85 dB.</p>		
10.6.2.2	<p>RS1 limits (to be superseded, see 10.6.3.2)</p> <p>RS1 is a class 1 acoustic energy source that does not exceed the following:</p> <ul style="list-style-type: none"> – for equipment provided as a package (player with its listening device), and with a proprietary connector between the player and its listening device, or where the combination of player and listening device is known by other means such as setting or automatic detection, the $L_{Aeq, T}$ acoustic output shall be ≤ 85 dB when playing the fixed “programme simulation noise” described in EN 50332-1. – for equipment provided with a standardized connector (for example, a 3,5 phone jack) that allows connection to a listening device for general use, the unweighted r.m.s. output voltage shall be ≤ 27 mV (analogue interface) or -25 dBFS (digital interface) when playing the fixed “programme simulation noise” described in EN 50332-1. – The RS1 limits will be updated for all devices as per 10.6.3.2. 		N/A
10.6.2.3	<p>RS2 limits (to be superseded, see 10.6.3.3)</p> <p>RS2 is a class 2 acoustic energy source that does</p>		N/A



IEC 62368_1E ATTACHMENT

Clause	Requirement + Test	Result - Remark	Verdict
	<p>not exceed the following:</p> <ul style="list-style-type: none"> – for equipment provided as a package (player with its listening device), and with a proprietary connector between the player and its listening device, or when the combination of player and listening device is known by other means such as setting or automatic 130 detection, the $L_{Aeq,T}$ acoustic output shall be ≤ 100 dB(A) when playing the fixed “programme simulation noise” as described in EN 50332-1. – for equipment provided with a standardized connector (for example, a 3,5 phone jack) that allows connection to a listening device for general use, the unweighted r.m.s. output voltage shall be ≤ 150 mV (analogue interface) or -10 dBFS (digital interface) when playing the fixed “programme simulation noise” as described in EN 50332-1. 		
10.6.2.4	<p>RS3 limits</p> <p>RS3 is a class 3 acoustic energy source that exceeds RS2 limits.</p>		N/A
10.6.3	Classification of devices (new)		N/A
10.6.3.1	<p>General</p> <p>Previous limits (10.6.2) created abundant false negative and false positive PMP sound level warnings. New limits, compliant with The Commission Decision of 23 June 2009, are given below.</p>		N/A
10.6.3.2	<p>RS1 limits (new)</p> <p>RS1 is a class 1 acoustic energy source that does not exceed the following:</p> <ul style="list-style-type: none"> – for equipment provided as a package (player with its listening device), and with a proprietary connector between the player and its listening device, or where the combination of player and listening device is known by other means such as setting or automatic detection, the $L_{Aeq,T}$ acoustic output shall be ≤ 80 dB when playing the fixed “programme simulation noise” described in EN 50332-1. – for equipment provided with a standardized connector (for example, a 3,5 phone jack) that allows connection to a listening device for general use, the unweighted r.m.s. output voltage shall be ≤ 15 mV (analogue interface) or -30 dBFS (digital interface) when playing the fixed “programme simulation noise” described in EN 50332-1. 		N/A



IEC 62368_1E ATTACHMENT			
Clause	Requirement + Test	Result - Remark	Verdict
10.6.3.3	RS2 limits (new) RS2 is a class 2 acoustic energy source that does not exceed the following: – for equipment provided as a package (player with its listening device), and with a proprietary connector between the player and its listening device, or where the combination of player and listening device is known by other means such as setting or automatic detection, the weekly sound exposure level, as described in EN 50332-3, shall be ≤ 80 dB when playing the fixed "programme simulation noise" described in EN 50332-1. – for equipment provided with a standardized connector (for example, a 3,5 phone jack) that allows connection to a listening device for general use, the unweighted r.m.s. output level, integrated over one week, as described in EN50332-3, shall be ≤ 15 mV (analogue interface) or -30 dBFS (digital interface) when playing the fixed "programme simulation noise" described in EN 50332-1.		N/A
10.6.4	Requirements for maximum sound exposure		N/A
10.6.4.1	Measurement methods All volume controls shall be turned to maximum during tests. Measurements shall be made in accordance with EN 50332-1 or EN 50332-2 as applicable.		N/A
10.6.4.2	Protection of persons Except as given below, protection requirements for parts accessible to ordinary persons, instructed persons and skilled persons are given in 4.3. NOTE 1 Volume control is not considered a safeguard . Between RS2 and an ordinary person , the basic safeguard may be replaced by an instructional safeguard in accordance with Clause F.5, except that the instructional safeguard shall be placed on the equipment, or on the packaging, or in the instruction manual. Alternatively, the instructional safeguard may be given through the equipment display during use. The elements of the instructional safeguard		N/A



IEC 62368_1E ATTACHMENT

Clause	Requirement + Test	Result - Remark	Verdict
	<p>shall be as follows:</p> <ul style="list-style-type: none"> – element 1a: the symbol , IEC 60417-6044 (2011-01) – element 2: “High sound pressure” or equivalent wording – element 3: “Hearing damage risk” or equivalent wording – element 4: “Do not listen at high volume levels for long periods.” or equivalent wording <p>An equipment safeguard shall prevent exposure of an ordinary person to an RS2 source without intentional physical action from the ordinary person and shall automatically return to an output level not exceeding what is specified for an RS1 source when the power is switched off.</p> <p>The equipment shall provide a means to actively inform the user of the increased sound level when the equipment is operated with an output exceeding RS1. Any means used shall be acknowledged by the user before activating a mode of operation which allows for an output exceeding RS1. The acknowledgement does not need to be repeated more than once every 20 h of cumulative listening time.</p> <p>NOTE 2 Examples of means include visual or audible signals. Action from the user is always needed.</p> <p>NOTE 3 The 20 h listening time is the accumulative listening time, independent of how often and how long the personal music player has been switched off.</p> <p>A skilled person shall not be unintentionally exposed to RS3.</p>		
10.6.5	Requirements for dose-based systems		N/A
10.6.5.1	<p>General requirements</p> <p>Personal music players shall give the warnings as provided below when tested according to EN 50332-3, using the limits from this clause.</p> <p>The manufacturer may offer optional settings to allow the users to modify when and how they wish to receive the notifications and warnings to promote a better user experience without</p>		N/A



IEC 62368_1E ATTACHMENT

Clause	Requirement + Test	Result - Remark	Verdict
	<p>defeating the safeguards. This allows the users to be informed in a method that best meets their physical capabilities and device usage needs. If such optional settings are offered, an administrator (for example, parental restrictions, business/educational administrators, etc.) shall be able to lock any optional settings into a specific configuration.</p> <p>The personal music player shall be supplied with easy to understand explanation to the user of the dose management system, the risks involved, and how to use the system safely. The user shall be made aware that other sources may significantly contribute to their sound exposure, for example work, transportation, concerts, clubs, cinema, car races, etc.</p>		
<p>10.6.5.2</p>	<p>Dose-based warning and requirements</p> <p>When a dose of 100 % <i>CSD</i> is reached, and at least at every 100 % further increase of <i>CSD</i>, the device shall warn the user and require an acknowledgement. In case the user does not acknowledge, the output level shall automatically decrease to compliance with class RS1.</p> <p>The warning shall at least clearly indicate that listening above 100 % <i>CSD</i> leads to the risk of hearing damage or loss.</p>		<p>N/A</p>
<p>10.6.5.3</p>	<p>Exposure-based requirements</p> <p>With only dose-based requirements, cause and effect could be far separated in time, defying the purpose of educating users about safe listening practice. In addition to dose-based requirements, a PMP shall therefore also put a limit to the short-term sound level a user can listen at.</p> <p>The exposure-based limiter (EL) shall automatically reduce the sound level not to exceed 100 dB(A) or 150 mV integrated over the past 180 s, based on methodology defined in EN 50332-3.</p> <p>The EL settling time (time from starting level reduction to reaching target output) shall be 10 s or faster.</p> <p>Test of EL functionality is conducted according to EN 50332-3, using the limits from this clause. For equipment provided as a package (player with its listening device), the level integrated over 180 s</p>		<p>N/A</p>



IEC 62368_1E ATTACHMENT

Clause	Requirement + Test	Result - Remark	Verdict
	<p>shall be 100 dB or lower. For equipment provided with a standardized connector, the unweighted level integrated over 180 s shall be no more than 150 mV for an analogue interface and no more than -10 dBFS for a digital interface.</p> <p>NOTE In case the source is known not to be music (or test signal), the EL may be disabled.</p>		
10.6.6	Requirements for listening devices (headphones, earphones, etc.)		N/A
10.6.6.1	<p>Corded listening devices with analogue input</p> <p>With 94 dB LAeq acoustic pressure output of the listening device, and with the volume and sound settings in the listening device (for example, built-in volume level control, additional sound features like equalization, etc.) set to the combination of positions that maximize the measured acoustic output, the input voltage of the listening device when playing the fixed “programme simulation noise” as described in EN 50332-1 shall be ≥ 75 mV.</p> <p>NOTE The values of 94 dB and 75 mV correspond with 85 dB and 27 mV or 100 dB and 150 mV.</p>		N/A
10.6.6.2	<p>Corded listening devices with digital input</p> <p>With any playing device playing the fixed “programme simulation noise” described in EN 50332-1, and with the volume and sound settings in the listening device (for example, built-in volume level control, additional sound features like equalization, etc.) set to the combination of positions that maximize the measured acoustic output, the LAeq,T acoustic output of the listening device shall be ≤ 100 dB with an input signal of -10 dBFS.</p>		N/A
10.6.6.3	<p>Cordless listening devices</p> <p>In cordless mode,</p> <ul style="list-style-type: none"> – with any playing and transmitting device playing the fixed programme simulation noise described in EN 50332-1; and – respecting the cordless transmission standards, where an air interface standard exists that specifies the equivalent acoustic level; and – with volume and sound settings in the receiving device (for example, built-in volume level control, additional sound features like equalization, etc.) set to the combination of positions that maximize the measured acoustic output for the above 		N/A



IEC 62368_1E ATTACHMENT

Clause	Requirement + Test	Result - Remark	Verdict																																																												
	mentioned programme simulation noise, the $L_{Aeq,T}$ acoustic output of the listening device shall be ≤ 100 dB with an input signal of -10 dBFS.																																																														
10.6.6.4	Measurement method <i>Measurements shall be made in accordance with EN 50332-2 as applicable.</i>		N/A																																																												
3	Modification to the whole document		--																																																												
	<p>Delete all the “country” notes in the reference document according to the following list:</p> <table border="1"> <tbody> <tr> <td>0.2.1</td> <td>Note 1 and 2</td> <td>1</td> <td>Note 4 and 5</td> <td>3.3.8.1</td> <td>Note 2</td> </tr> <tr> <td>3.3.8.3</td> <td>Note 1</td> <td>4.1.15</td> <td>Note</td> <td>4.7.3</td> <td>Note 1 and 2</td> </tr> <tr> <td>5.2.2.2</td> <td>Note</td> <td>5.4.2.3.2.2 Table 12</td> <td>Note c</td> <td>5.4.2.3.2.4</td> <td>Note 1 and 3</td> </tr> <tr> <td>5.4.2.3.2.4 Table 13</td> <td>Note 2</td> <td>5.4.2.5</td> <td>Note 2</td> <td>5.4.5.1</td> <td>Note</td> </tr> <tr> <td>5.4.10.2.1</td> <td>Note</td> <td>5.4.10.2.2</td> <td>Note</td> <td>5.4.10.2.3</td> <td>Note</td> </tr> <tr> <td>5.5.2.1</td> <td>Note</td> <td>5.5.6</td> <td>Note</td> <td>5.6.4.2.1</td> <td>Note 2 and 3 and 4</td> </tr> <tr> <td>5.6.8</td> <td>Note 2</td> <td>5.7.6</td> <td>Note</td> <td>5.7.7.1</td> <td>Note 1 and Note 2</td> </tr> <tr> <td>8.5.4.2.3</td> <td>Note</td> <td>10.2.1 Table 39</td> <td>Note 3 and 4 and 5</td> <td>10.5.3</td> <td>Note 2</td> </tr> <tr> <td>10.6.4</td> <td>Note 3</td> <td>F.3.3.6</td> <td>Note 3</td> <td>Y.4.1</td> <td>Note</td> </tr> <tr> <td>Y.4.5</td> <td>Note</td> <td></td> <td></td> <td></td> <td></td> </tr> </tbody> </table>	0.2.1	Note 1 and 2	1	Note 4 and 5	3.3.8.1	Note 2	3.3.8.3	Note 1	4.1.15	Note	4.7.3	Note 1 and 2	5.2.2.2	Note	5.4.2.3.2.2 Table 12	Note c	5.4.2.3.2.4	Note 1 and 3	5.4.2.3.2.4 Table 13	Note 2	5.4.2.5	Note 2	5.4.5.1	Note	5.4.10.2.1	Note	5.4.10.2.2	Note	5.4.10.2.3	Note	5.5.2.1	Note	5.5.6	Note	5.6.4.2.1	Note 2 and 3 and 4	5.6.8	Note 2	5.7.6	Note	5.7.7.1	Note 1 and Note 2	8.5.4.2.3	Note	10.2.1 Table 39	Note 3 and 4 and 5	10.5.3	Note 2	10.6.4	Note 3	F.3.3.6	Note 3	Y.4.1	Note	Y.4.5	Note						P
0.2.1	Note 1 and 2	1	Note 4 and 5	3.3.8.1	Note 2																																																										
3.3.8.3	Note 1	4.1.15	Note	4.7.3	Note 1 and 2																																																										
5.2.2.2	Note	5.4.2.3.2.2 Table 12	Note c	5.4.2.3.2.4	Note 1 and 3																																																										
5.4.2.3.2.4 Table 13	Note 2	5.4.2.5	Note 2	5.4.5.1	Note																																																										
5.4.10.2.1	Note	5.4.10.2.2	Note	5.4.10.2.3	Note																																																										
5.5.2.1	Note	5.5.6	Note	5.6.4.2.1	Note 2 and 3 and 4																																																										
5.6.8	Note 2	5.7.6	Note	5.7.7.1	Note 1 and Note 2																																																										
8.5.4.2.3	Note	10.2.1 Table 39	Note 3 and 4 and 5	10.5.3	Note 2																																																										
10.6.4	Note 3	F.3.3.6	Note 3	Y.4.1	Note																																																										
Y.4.5	Note																																																														
4	Modification to Clause 1		--																																																												
1	Add the following note: <i>NOTE Z1 The use of certain substances in electrical and electronic equipment is restricted within the EU: see Directive 2011/65/EU.</i>		N/A																																																												
5	Modification to 4.Z1		--																																																												



IEC 62368_1E ATTACHMENT

Clause	Requirement + Test	Result - Remark	Verdict
4.Z1	<p>Add the following new subclause after 4.9:</p> <p>To protect against excessive current, short-circuits and earth faults in circuits connected to an a.c. mains, protective devices shall be included either as integral parts of the equipment or as parts of the building installation, subject to the following, a), b) and c):</p> <p>a) except as detailed in b) and c), protective devices necessary to comply with the requirements of B.3.1 and B.4 shall be included as parts of the equipment;</p> <p>b) for components in series with the mains input to the equipment such as the supply cord, appliance coupler, r.f.i. filter and switch, short-circuit and earth fault protection may be provided by protective devices in the building installation;</p> <p>c) it is permitted for pluggable equipment type B or permanently connected equipment, to rely on dedicated overcurrent and short-circuit protection in the building installation, provided that the means of protection, e.g. fuses or circuit breakers, is fully specified in the installation instructions.</p> <p>If reliance is placed on protection in the building installation, the installation instructions shall so state, except that for pluggable equipment type A the building installation shall be regarded as providing protection in accordance with the rating of the wall socket outlet.</p>		N/A
6	Modification to 5.4.2.3.2.4		--
5.4.2.3.2.4	<p>Add the following to the end of this subclause:</p> <p>The requirement for interconnection with external circuit is in addition given in EN 50491-3:2009.</p>		N/A
7	Modification to 10.2.1		--
10.2.1	<p>Add the following to ^{c)} and ^{d)} in table 39:</p> <p>For additional requirements, see 10.5.1.</p>		N/A
8	Modification to 10.5.1		--



IEC 62368_1E ATTACHMENT

Clause	Requirement + Test	Result - Remark	Verdict
10.5.1	<p>Add the following after the first paragraph:</p> <p>For RS 1 compliance is checked by measurement under the following conditions:</p> <p>In addition to the normal operating conditions, all controls adjustable from the outside by hand, by any object such as a tool or a coin, and those internal adjustments or pre-sets which are not locked in a reliable manner, are adjusted so as to give maximum radiation whilst maintaining an intelligible picture for 1 h, at the end of which the measurement is made.</p> <p>NOTE Z1 Soldered joints and paint lockings are examples of adequate locking.</p> <p>The dose-rate is determined by means of a radiation monitor with an effective area of 10 cm², at any point 10 cm from the outer surface of the apparatus.</p> <p>Moreover, the measurement shall be made under fault conditions causing an increase of the high voltage, provided an intelligible picture is maintained for 1 h, at the end of which the measurement is made.</p> <p>For RS1, the dose-rate shall not exceed 1 μSv/h taking account of the background level.</p> <p>NOTE Z2 These values appear in Directive 96/29/Euratom of 13 May 1996.</p>		N/A
9	Modification to G.7.1		--
G.7.1	<p>Add the following note:</p> <p>NOTE Z1 The harmonized code designations corresponding to the IEC cord types are given in Annex ZD.</p>		N/A
10	Modification to Bibliography		--



IEC 62368_1E ATTACHMENT			
Clause	Requirement + Test	Result - Remark	Verdict
	<p>Add the following notes for the standards indicated:</p> <p>IEC 60130-9 NOTE Harmonized as EN 60130-9. IEC 60269-2 NOTE Harmonized as HD 60269-2. IEC 60309-1 NOTE Harmonized as EN 60309-1. IEC 60364 NOTE some parts harmonized in HD 384/HD 60364 series. IEC 60601-2-4 NOTE Harmonized as EN 60601-2-4. IEC 60664-5 NOTE Harmonized as EN 60664-5. IEC 61032:1997 NOTE Harmonized as EN 61032:1998 (not modified). IEC 61508-1 NOTE Harmonized as EN 61508-1. IEC 61558-2-1 NOTE Harmonized as EN 61558-2-1. IEC 61558-2-4 NOTE Harmonized as EN 61558-2-4. IEC 61558-2-6 NOTE Harmonized as EN 61558-2-6. IEC 61643-1 NOTE Harmonized as EN 61643-1. IEC 61643-21 NOTE Harmonized as EN 61643-21. IEC 61643-311 NOTE Harmonized as EN 61643-311. IEC 61643-321 NOTE Harmonized as EN 61643-321. IEC 61643-331 NOTE Harmonized as EN 61643-331.</p>		N/A
11	ADDITION OF ANNEXES		--
ZB	ANNEX ZB, SPECIAL NATIONAL CONDITIONS (EN)		N/A
4.1.15	<p>Denmark, Finland, Norway and Sweden</p> <p>To the end of the subclause the following is added: Class I pluggable equipment type A intended for connection to other equipment or a network shall, if safety relies on connection to reliable earthing or if surge suppressors are connected between the network terminals and accessible parts, have a marking stating that the equipment shall be connected to an earthed mains socket-outlet.</p> <p>The marking text in the applicable countries shall be as follows:</p> <p>In Denmark: "Apparatets stikprop skal tilsluttes en stikkontakt med jord som giver forbindelse til stikproppens jord." In Finland: "Laite on liitettävä suojakoskettimilla varustettuun pistorasiaan" In Norway: "Apparatet må tilkoples jordet stikkontakt" In Sweden: "Apparaten skall anslutas till jordat uttag"</p>		N/A
4.7.3	<p>United Kingdom</p> <p>To the end of the subclause the following is</p>		N/A



IEC 62368_1E ATTACHMENT			
Clause	Requirement + Test	Result - Remark	Verdict
	<p>added:</p> <p>The torque test is performed using a socket-outlet complying with BS 1363, and the plug part shall be assessed to the relevant clauses of BS 1363. Also see Annex G.4.2 of this annex</p>		
5.2.2.2	<p>Denmark</p> <p>After the 2nd paragraph add the following:</p> <p>A warning (marking safeguard) for high touch current is required if the touch current exceeds the limits of 3,5 mA a.c. or 10 mA d.c.</p>		N/A
5.4.11.1 and Annex G	<p>Finland and Sweden</p> <p>To the end of the subclause the following is added:</p> <p>For separation of the telecommunication network from earth the following is applicable:</p> <p>If this insulation is solid, including insulation forming part of a component, it shall at least consist of either</p> <ul style="list-style-type: none"> • two layers of thin sheet material, each of which shall pass the electric strength test below, or • one layer having a distance through insulation of at least 0,4 mm, which shall pass the electric strength test below. <p>If this insulation forms part of a semiconductor component (e.g. an optocoupler), there is no distance through insulation requirement for the insulation consisting of an insulating compound completely filling the casing, so that clearances and creepage distances do not exist, if the component passes the electric strength test in accordance with the compliance clause below and in addition</p> <ul style="list-style-type: none"> • passes the tests and inspection criteria of 5.4.8 with an electric strength test of 1,5 kV multiplied by 1,6 (the electric strength test of 5.4.9 shall be performed using 1,5 kV), <p>and</p> <ul style="list-style-type: none"> • is subject to routine testing for electric strength during manufacturing, using a test voltage of 1,5 kV. 		N/A



IEC 62368_1E ATTACHMENT

Clause	Requirement + Test	Result - Remark	Verdict
	<p>It is permitted to bridge this insulation with a capacitor complying with EN 60384-14:2005, subclass Y2.</p> <p>A capacitor classified Y3 according to EN 60384-14:2005, may bridge this insulation under the following conditions:</p> <ul style="list-style-type: none"> the insulation requirements are satisfied by having a capacitor classified Y3 as defined by EN 60384-14, which in addition to the Y3 testing, is tested with an impulse test of 2,5 kV defined in 5.4.11; the additional testing shall be performed on all the test specimens as described in EN 60384-14; <p>the impulse test of 2,5 kV is to be performed before the endurance test in EN 60384-14, in the sequence of tests as described in EN 60384-14.</p>		
5.5.2.1	<p>Norway</p> <p>After the 3rd paragraph the following is added:</p> <p>Due to the IT power system used, capacitors are required to be rated for the applicable line-to-line voltage (230 V).</p>		N/A
5.5.6	<p>Finland, Norway and Sweden</p> <p>To the end of the subclause the following is added:</p> <p>Resistors used as basic safeguard or bridging basic insulation in class I pluggable equipment type A shall comply with G.10.1 and the test of G.10.2.</p>		N/A
5.6.1	<p>Denmark</p> <p>Add to the end of the subclause</p> <p>Due to many existing installations where the socket-outlets can be protected with fuses with higher rating than the rating of the socket-outlets the protection for pluggable equipment type A shall be an integral part of the equipment.</p> <p><i>Justification:</i></p> <p>In Denmark an existing 13 A socket outlet can be protected by a 20 A fuse.</p>		N/A



IEC 62368_1E ATTACHMENT			
Clause	Requirement + Test	Result - Remark	Verdict
5.6.4.2.1	Ireland and United Kingdom After the indent for pluggable equipment type A , the following is added: – the protective current rating is taken to be 13 A, this being the largest rating of fuse used in the mains plug .		N/A
5.6.4.2.1	France After the indent for pluggable equipment type A , the following is added: – in certain cases, the protective current rating of the circuit supplied from the mains is taken as 20 A instead of 16 A.		N/A
5.6.5.1	To the second paragraph the following is added: The range of conductor sizes of flexible cords to be accepted by terminals for equipment with a rated current over 10 A and up to and including 13 A is: 1,25 mm ² to 1,5 mm ² in cross-sectional area.		N/A
5.6.8	Norway To the end of the subclause the following is added: Equipment connected with an earthed mains plug is classified as class I equipment . See the Norway marking requirement in 4.1.15. The symbol IEC 60417-6092, as specified in F.3.6.2, is accepted.		N/A
5.7.6	Denmark To the end of the subclause the following is added: The installation instruction shall be affixed to the equipment if the protective conductor current exceeds the limits of 3,5 mA a.c. or 10 mA d.c.		N/A
5.7.6.2	Denmark To the end of the subclause the following is added: The warning (marking safeguard) for high touch current is required if the touch current or the protective current exceed the limits of 3,5 mA .		N/A
5.7.7.1	Norway and Sweden To the end of the subclause the following is added: The screen of the television distribution system is normally not earthed at the entrance of the		N/A



IEC 62368_1E ATTACHMENT

Clause	Requirement + Test	Result - Remark	Verdict
	<p>building and there is normally no equipotential bonding system within the building. Therefore the protective earthing of the building installation needs to be isolated from the screen of a cable distribution system.</p> <p>It is however accepted to provide the insulation external to the equipment by an adapter or an interconnection cable with galvanic isolator, which may be provided by a retailer, for example.</p> <p>The user manual shall then have the following or similar information in Norwegian and Swedish language respectively, depending on in what country the equipment is intended to be used in:</p> <p>“Apparatus connected to the protective earthing of the building installation through the mains connection or through other apparatus with a connection to protective earthing – and to a television distribution system using coaxial cable, may in some circumstances create a fire hazard. Connection to a television distribution system therefore has to be provided through a device providing electrical isolation below a certain frequency range (galvanic isolator, see EN 60728-11)”</p> <p>NOTE In Norway, due to regulation for CATV-installations, and in Sweden, a galvanic isolator shall provide electrical insulation below 5 MHz. The insulation shall withstand a dielectric strength of 1,5 kV r.m.s., 50 Hz or 60 Hz, for 1 min.</p> <p>Translation to Norwegian (the Swedish text will also be accepted in Norway):</p> <p>“Apparater som er koplet til beskyttelsesjord via nettplugg og/eller via annet jordtilkøpelt utstyr – og er tilkøpelt et koaksialbasert kabel-TV nett, kan forårsake brannfare. For å unngå dette skal det ved tilkopling av apparater til kabel-TV nett installeres en galvanisk isolator mellom apparatet og kabel-TV nettet.”</p> <p>Translation to Swedish: ”Apparater som är kopplad till skyddsjord via jordat vägguttag och/eller via annan utrustning och samtidigt är kopplad till kabel-TV nät kan i vissa fall medföra risk för brand. För att undvika detta skall vid anslutning av apparaten till kabel-</p>		



IEC 62368_1E ATTACHMENT

Clause	Requirement + Test	Result - Remark	Verdict
	TV nät galvanisk isolator finnas mellan apparaten och kabel-TV nätet.”.		
8.5.4.2.3	<p>United Kingdom</p> <p>Add the following after the 2nd dash bullet in 3rd paragraph:</p> <p>An emergency stop system complying with the requirements of IEC 60204-1 and ISO 13850 is required where there is a risk of personal injury.</p>		N/A
B.3.1 and B.4	<p>Ireland and United Kingdom</p> <p>The following is applicable:</p> <p>To protect against excessive currents and short-circuits in the primary circuit of direct plug-in equipment, tests according to Annexes B.3.1 and B.4 shall be conducted using an external miniature circuit breaker complying with EN 60898-1, Type B, rated 32A. If the equipment does not pass these tests, suitable protective devices shall be included as an integral part of the direct plug-in equipment, until the requirements of Annexes B.3.1 and B.4 are met</p>		N/A
G.4.2	<p>Denmark</p> <p>To the end of the subclause the following is added:</p> <p>Supply cords of single phase appliances having a rated current not exceeding 13 A shall be provided with a plug according to DS 60884-2-D1:2011.</p> <p>CLASS I EQUIPMENT provided with socket-outlets with earth contacts or which are intended to be used in locations where protection against indirect contact is required according to the wiring rules shall be provided with a plug in accordance with standard sheet DK 2-1a or DK 2-5a.</p> <p>If a single-phase equipment having a RATED CURRENT exceeding 13 A or if a polyphase equipment is provided with a supply cord with a plug, this plug shall be in accordance with the standard sheets DK 6-1a in DS 60884-2-D1 or EN 60309-2.</p> <p>Mains socket outlets intended for providing power to Class II apparatus with a rated current of 2,5 A shall be in accordance DS 60884-2-D1:2011</p>		N/A



IEC 62368_1E ATTACHMENT

Clause	Requirement + Test	Result - Remark	Verdict
	<p>standard sheet DKA 1-4a.</p> <p>Other current rating socket outlets shall be in compliance with Standard Sheet DKA 1-3a or DKA 1-1c.</p> <p>Mains socket-outlets with earth shall be in compliance with DS 60884-2-D1:2011 Standard Sheet DK 1-3a, DK 1-1c, DK1-1d, DK 1-5a or DK 1-7a</p> <p><i>Justification:</i> Heavy Current Regulations, Section 6c</p>		
G.4.2	<p>United Kingdom</p> <p>To the end of the subclause the following is added:</p> <p>The plug part of direct plug-in equipment shall be assessed to BS 1363: Part 1, 12.1, 12.2, 12.3, 12.9, 12.11, 12.12, 12.13, 12.16, and 12.17, except that the test of 12.17 is performed at not less than 125 °C. Where the metal earth pin is replaced by an Insulated Shutter Opening Device (ISOD), the requirements of clauses 22.2 and 23 also apply.</p>		N/A
G.7.1	<p>United Kingdom</p> <p>To the first paragraph the following is added:</p> <p>Equipment which is fitted with a flexible cable or cord and is designed to be connected to a mains socket conforming to BS 1363 by means of that flexible cable or cord shall be fitted with a 'standard plug' in accordance with the Plugs and Sockets etc. (Safety) Regulations 1994, Statutory Instrument 1994 No. 1768, unless exempted by those regulations.</p> <p>NOTE "Standard plug" is defined in SI 1768:1994 and essentially means an approved plug conforming to BS 1363 or an approved conversion plug.</p>		N/A
G.7.1	<p>Ireland</p> <p>To the first paragraph the following is added:</p> <p>Apparatus which is fitted with a flexible cable or cord shall be provided with a plug in accordance with Statutory Instrument 525: 1997, "13 A Plugs and Conversion Adapters for Domestic Use</p>		N/A



IEC 62368_1E ATTACHMENT

Clause	Requirement + Test	Result - Remark	Verdict
--------	--------------------	-----------------	---------

	Regulations: 1997. S.I. 525 provides for the recognition of a standard of another Member State which is equivalent to the relevant Irish Standard		
G.7.2	Ireland and United Kingdom To the first paragraph the following is added: A power supply cord with a conductor of 1,25 mm ² is allowed for equipment which is rated over 10 A and up to and including 13 A.		N/A

ZC	ANNEX ZC, NATIONAL DEVIATIONS (EN)		N/A
10.5.2	Germany The following requirement applies: For the operation of any cathode ray tube intended for the display of visual images operating at an acceleration voltage exceeding 40 kV, authorization is required, or application of type approval (Bauartzulassung) and marking. <i>Justification:</i> German ministerial decree against ionizing radiation (Röntgenverordnung), in force since 2002-07-01, implementing the European Directive 96/29/EURATOM. NOTE Contact address: Physikalisch-Technische Bundesanstalt, Bundesallee 100, D-38116 Braunschweig, Tel.: Int+49-531-592-6320, Internet: http://www.ptb.de		N/A



IEC 62368_1E ATTACHMENT

Clause	Requirement + Test	Result - Remark	Verdict
--------	--------------------	-----------------	---------

ZD	IEC and CENELEC CODE DESIGNATIONS FOR FLEXIBLE CORDS (EN)	N/A																																																					
	<table border="1"> <thead> <tr> <th rowspan="2">Type of flexible cord</th> <th colspan="2">Code designations</th> </tr> <tr> <th>IEC</th> <th>CENELEC</th> </tr> </thead> <tbody> <tr> <td colspan="3">PVC insulated cords</td> </tr> <tr> <td>Flat twin tinsel cord</td> <td>60227 IEC 41</td> <td>H03VH-Y</td> </tr> <tr> <td>Light polyvinyl chloride sheathed flexible cord</td> <td>60227 IEC 52</td> <td>H03VV-F H03VVH2-F</td> </tr> <tr> <td>Ordinary polyvinyl chloride sheathed flexible cord</td> <td>60227 IEC 53</td> <td>H05VV-F H05VVH2-F</td> </tr> <tr> <td colspan="3">Rubber insulated cords</td> </tr> <tr> <td>Braided cord</td> <td>60245 IEC 51</td> <td>H03RT-F</td> </tr> <tr> <td>Ordinary tough rubber sheathed flexible cord</td> <td>60245 IEC 53</td> <td>H05RR-F</td> </tr> <tr> <td>Ordinary polychloroprene sheathed flexible cord</td> <td>60245 IEC 57</td> <td>H05RN-F</td> </tr> <tr> <td>Heavy polychloroprene sheathed flexible cord</td> <td>60245 IEC 66</td> <td>H07RN-F</td> </tr> <tr> <td colspan="3">Cords having high flexibility</td> </tr> <tr> <td>Rubber insulated and sheathed cord</td> <td>60245 IEC 86</td> <td>H03RR-H</td> </tr> <tr> <td>Rubber insulated, crosslinked PVC sheathed cord</td> <td>60245 IEC 87</td> <td>H03RV4-H</td> </tr> <tr> <td>Crosslinked PVC insulated and sheathed cord</td> <td>60245 IEC 88</td> <td>H03V4V4-H</td> </tr> <tr> <td colspan="3">Cords insulated and sheathed with halogen-free thermoplastic compounds</td> </tr> <tr> <td>Light halogen-free thermoplastic insulated and sheathed flexible cords</td> <td></td> <td>H03Z1Z1-F H03Z1Z1H2-F</td> </tr> <tr> <td>Ordinary halogen-free thermoplastic insulated and sheathed flexible cords</td> <td></td> <td>H05Z1Z1-F H05Z1Z1H2-F</td> </tr> </tbody> </table>	Type of flexible cord	Code designations		IEC	CENELEC	PVC insulated cords			Flat twin tinsel cord	60227 IEC 41	H03VH-Y	Light polyvinyl chloride sheathed flexible cord	60227 IEC 52	H03VV-F H03VVH2-F	Ordinary polyvinyl chloride sheathed flexible cord	60227 IEC 53	H05VV-F H05VVH2-F	Rubber insulated cords			Braided cord	60245 IEC 51	H03RT-F	Ordinary tough rubber sheathed flexible cord	60245 IEC 53	H05RR-F	Ordinary polychloroprene sheathed flexible cord	60245 IEC 57	H05RN-F	Heavy polychloroprene sheathed flexible cord	60245 IEC 66	H07RN-F	Cords having high flexibility			Rubber insulated and sheathed cord	60245 IEC 86	H03RR-H	Rubber insulated, crosslinked PVC sheathed cord	60245 IEC 87	H03RV4-H	Crosslinked PVC insulated and sheathed cord	60245 IEC 88	H03V4V4-H	Cords insulated and sheathed with halogen-free thermoplastic compounds			Light halogen-free thermoplastic insulated and sheathed flexible cords		H03Z1Z1-F H03Z1Z1H2-F	Ordinary halogen-free thermoplastic insulated and sheathed flexible cords		H05Z1Z1-F H05Z1Z1H2-F	N/A
Type of flexible cord	Code designations																																																						
	IEC	CENELEC																																																					
PVC insulated cords																																																							
Flat twin tinsel cord	60227 IEC 41	H03VH-Y																																																					
Light polyvinyl chloride sheathed flexible cord	60227 IEC 52	H03VV-F H03VVH2-F																																																					
Ordinary polyvinyl chloride sheathed flexible cord	60227 IEC 53	H05VV-F H05VVH2-F																																																					
Rubber insulated cords																																																							
Braided cord	60245 IEC 51	H03RT-F																																																					
Ordinary tough rubber sheathed flexible cord	60245 IEC 53	H05RR-F																																																					
Ordinary polychloroprene sheathed flexible cord	60245 IEC 57	H05RN-F																																																					
Heavy polychloroprene sheathed flexible cord	60245 IEC 66	H07RN-F																																																					
Cords having high flexibility																																																							
Rubber insulated and sheathed cord	60245 IEC 86	H03RR-H																																																					
Rubber insulated, crosslinked PVC sheathed cord	60245 IEC 87	H03RV4-H																																																					
Crosslinked PVC insulated and sheathed cord	60245 IEC 88	H03V4V4-H																																																					
Cords insulated and sheathed with halogen-free thermoplastic compounds																																																							
Light halogen-free thermoplastic insulated and sheathed flexible cords		H03Z1Z1-F H03Z1Z1H2-F																																																					
Ordinary halogen-free thermoplastic insulated and sheathed flexible cords		H05Z1Z1-F H05Z1Z1H2-F																																																					



Product photos

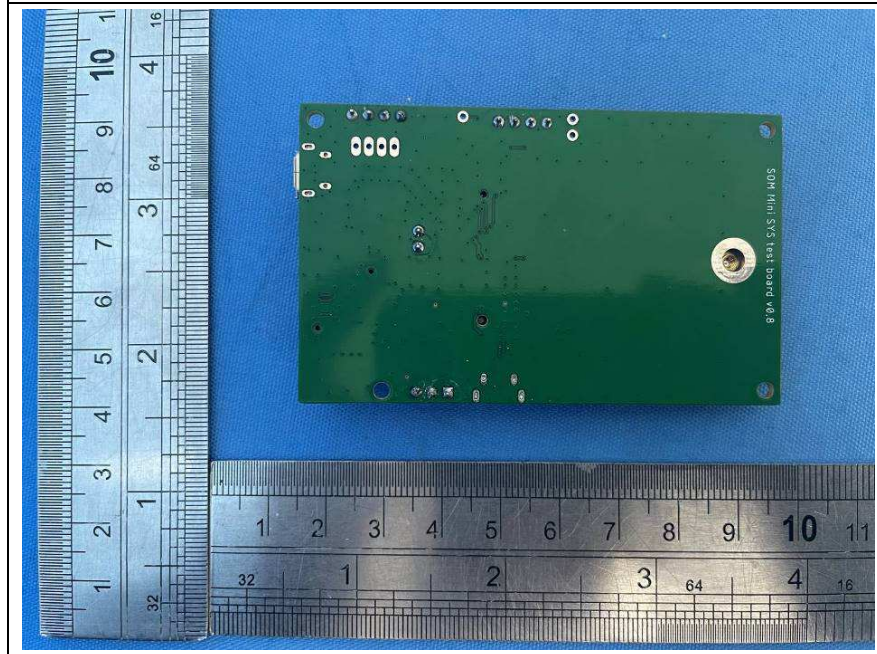
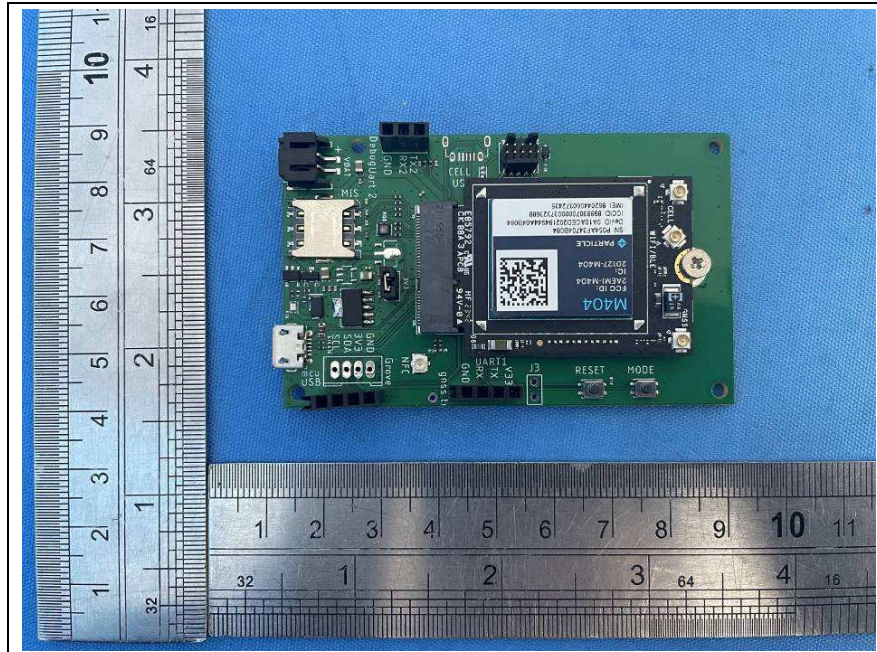



**BUREAU
VERITAS**

Test Report No.: RD2312WDG0147

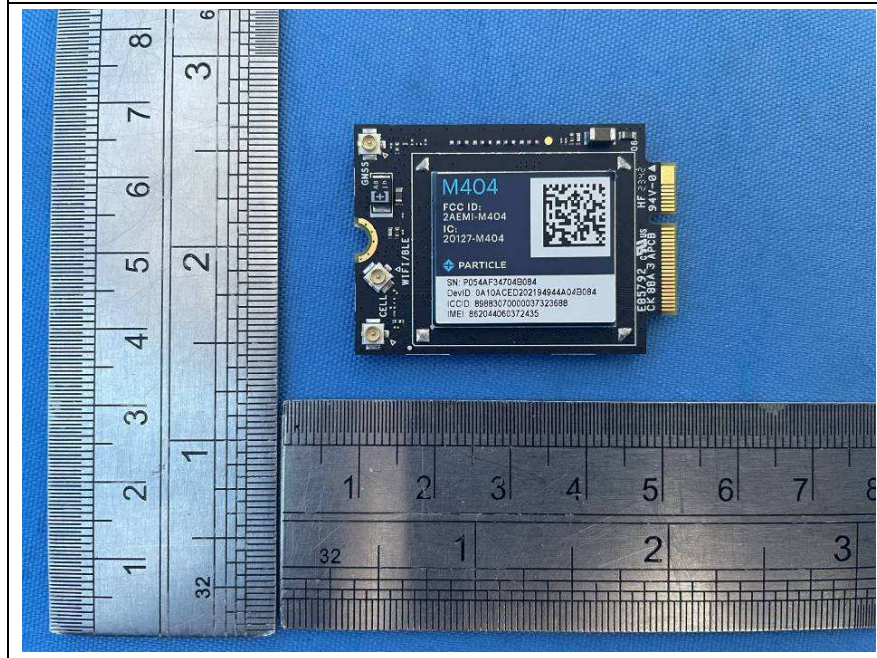
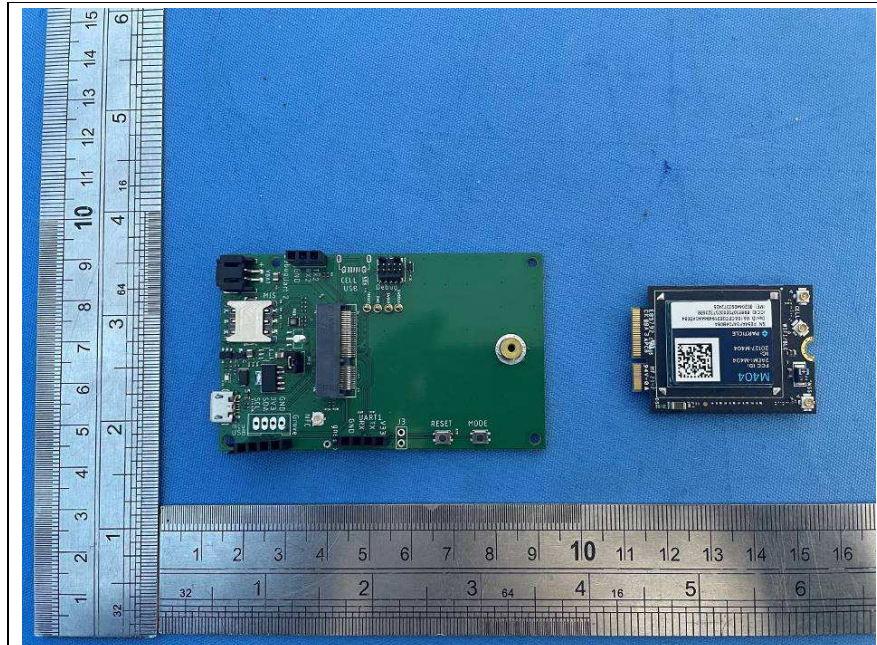

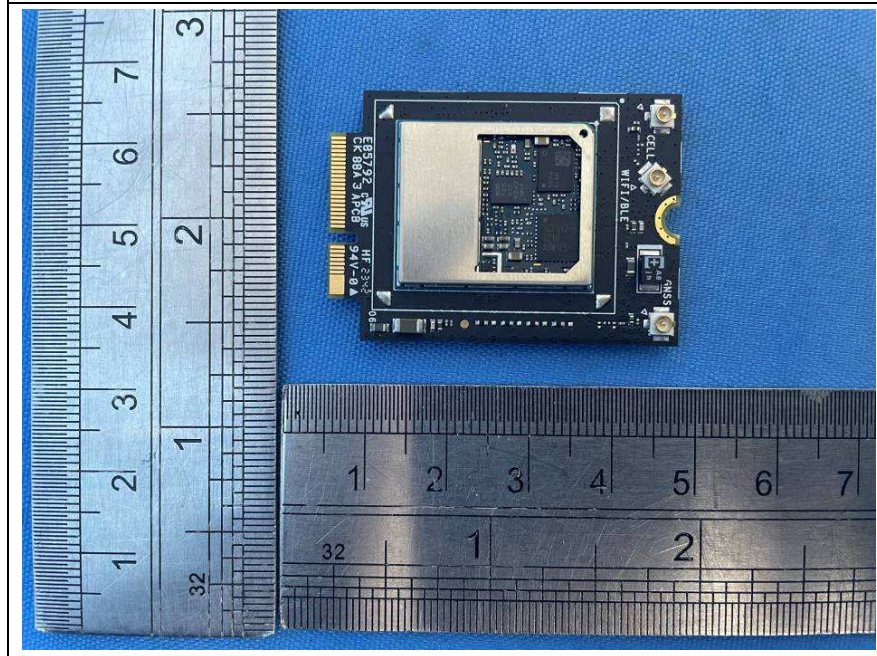
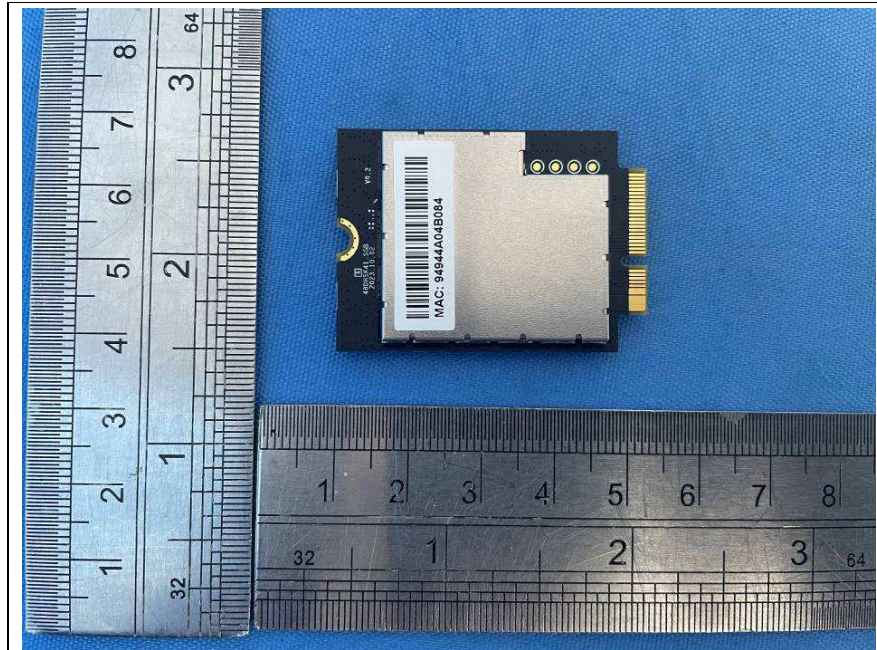



**BUREAU
VERITAS**

Test Report No.: RD2312WDG0147

